

# CTLS - POLARITY IN RECESSED COMMERCIAL TRACK LIGHT SYSTEM

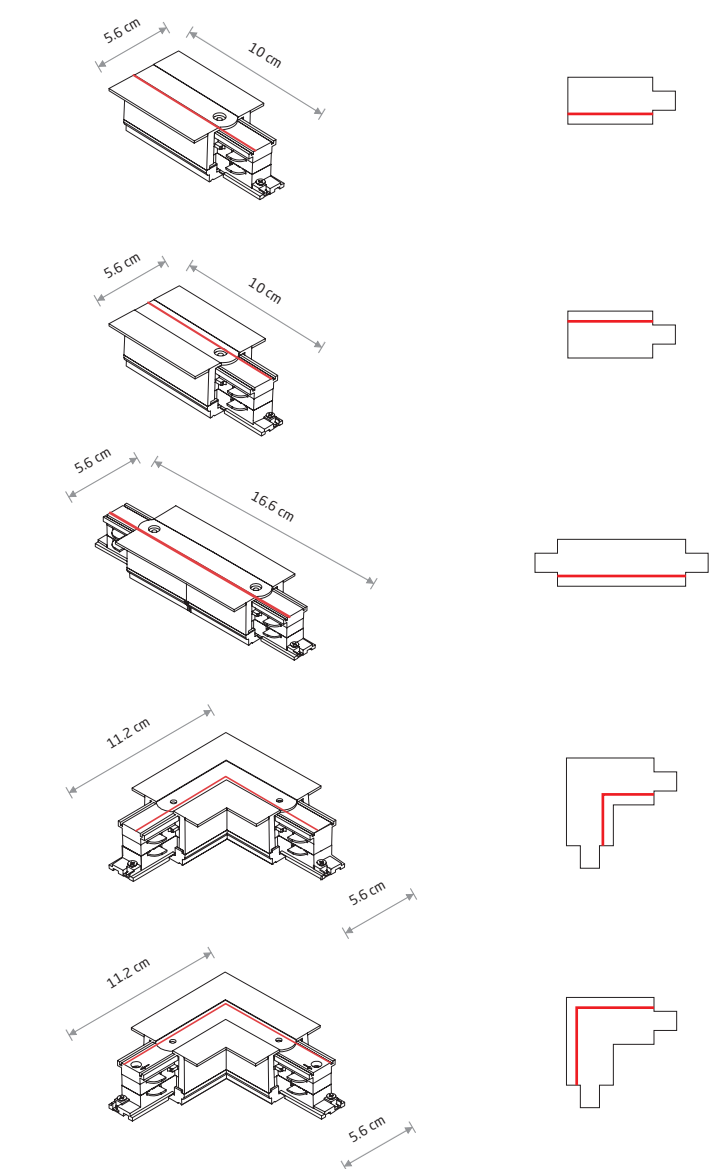
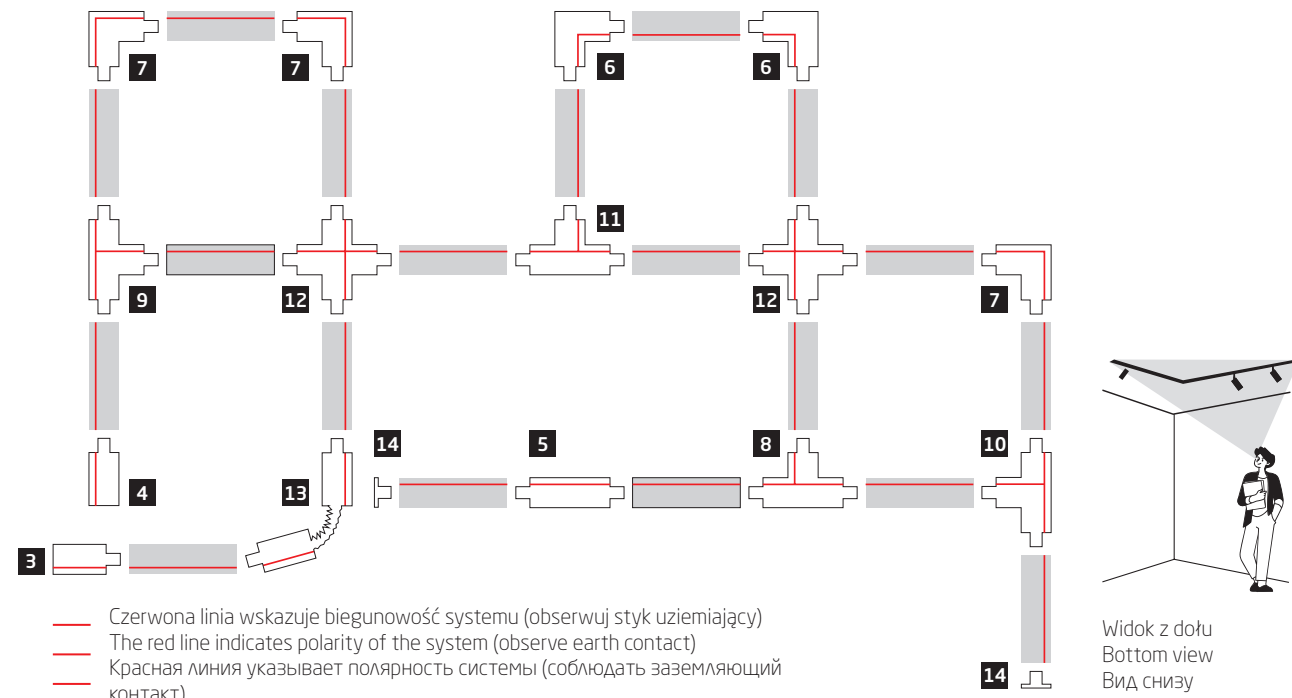

**3 CTLS RECESSED POWER END CAP, RIGHT (PE-R)**  
plastic, copper

8691 8690

**4 CTLS RECESSED POWER END CAP, LEFT (PE-L)**  
plastic, copper

8234 8235

**5 CTLS RECESSED POWER STRAIGHT CONNECTOR**  
plastic, copper

8686 8685

**6 CTLS RECESSED POWER L CONNECTOR, RIGHT (L-R)**  
plastic, copper

8230 8231

**7 CTLS RECESSED POWER L CONNECTOR, LEFT (L-L)**  
plastic, copper

8684 8683

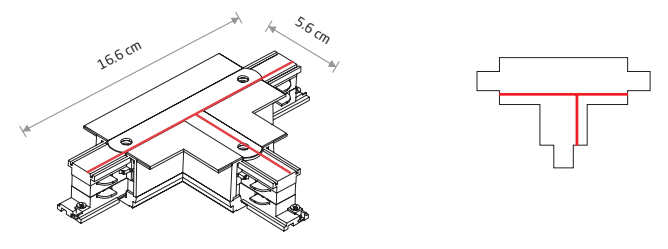

**8 CTLS RECESSED POWER T CONNECTOR, LEFT 2 (T-L2)**  
plastic, copper

8238 8240

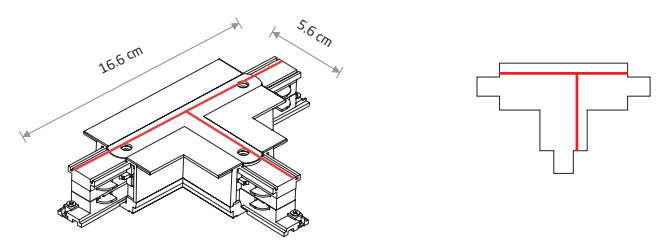

**9 CTLS RECESSED POWER T CONNECTOR, LEFT 1 (T-L1)**  
plastic, copper

8247 8248

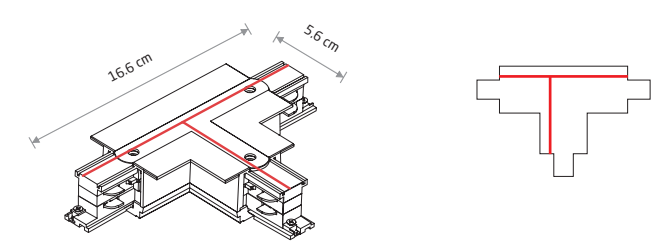

**10 CTLS RECESSED POWER T CONNECTOR, RIGHT 2 (T-R2)**  
plastic, copper

8681 8682

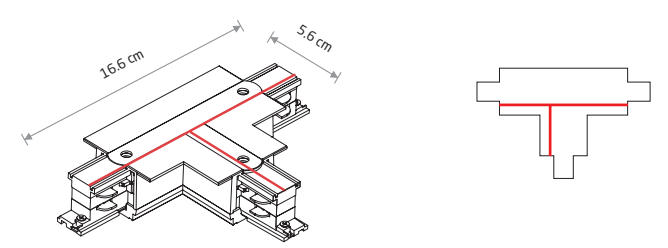

**11 CTLS RECESSED POWER T CONNECTOR, RIGHT 1 (T-R1)**  
plastic, copper

8245 8246

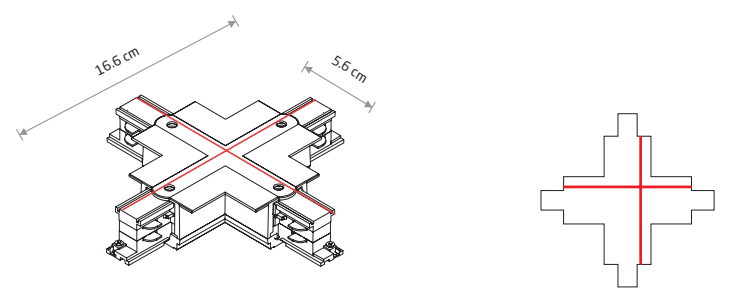

**12 CTLS RECESSED POWER X CONNECTOR**  
plastic, copper

8678 8680

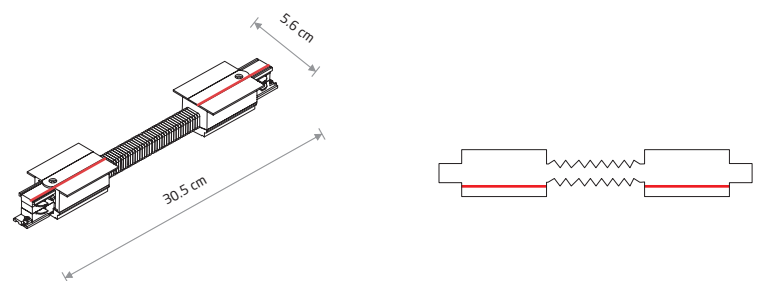

**13 CTLS RECESSED POWER FLEX CONNECTOR**  
plastic, copper

8676 8677



**14 CTLS RECESSED DEAD END CAP**  
plastic

8688 8687



**15 CTLS RECESSED FIXING SET**  
steel

8306

WHITE BLACK

OTHER WHITE BLACK