

abcMIX
REDEFINE SIGNAGE



Create Your Sign

Table of contents

Company profile · 01-24

Products introduction · 25-132

FORWORD

READY-MADE · EASY · THE COMBINER

READY-MADE

COMPLETE ALPHABETIC TABLES AND ARABIC NUMERALS,
YOU ORDER, WE DELIVER, NO PRODUCTION LEAD TIME

EASY

THE SIMPLEST DESIGN,
MAGNETIC CONNECTION, 1 MINUTE SIGNAGE

THE COMBINER

CREATIVE DIY, RANDOM GROUPING, PASSIONATE EXPRESSION

THE KEY OF OUR BRAND:

REDEFINE SIGNAGE

READY-MADE · EASY · QUALITY

READY-MADE · EASY · FREE-MATCH

READY-MADE · EASY · THE COMBINER

MIX & MATCH LED SIGNS A TO Z

CREATE YOUR OWN SIGN

FIND YOUR FLAIR

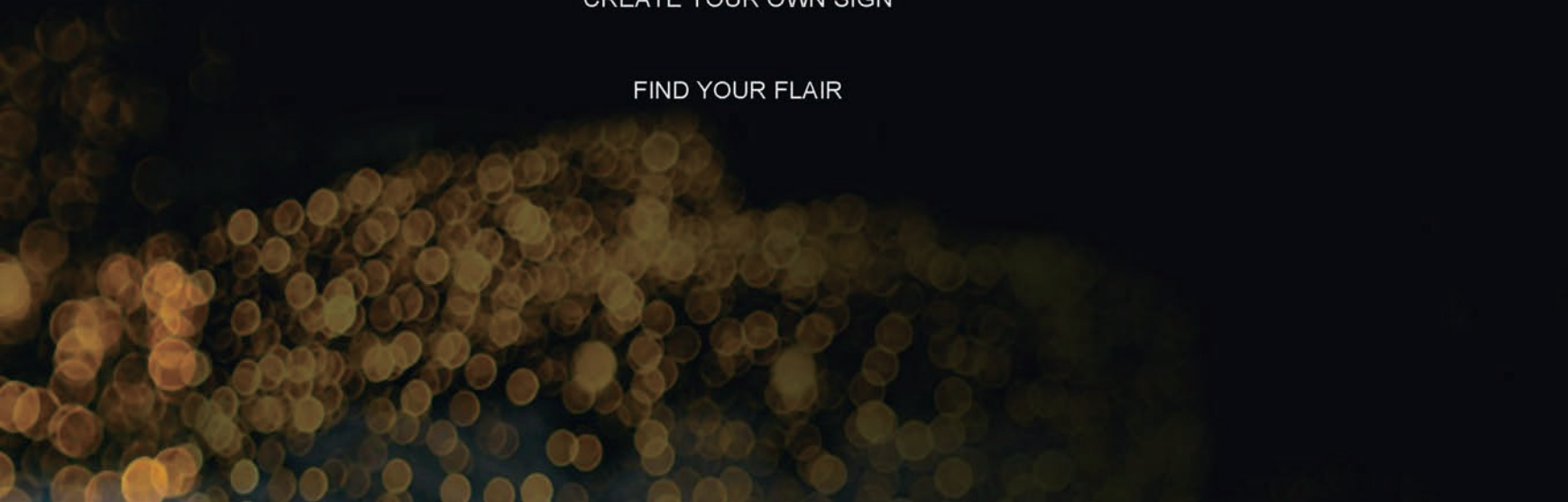



abcMIX

abcMIX

COMPANY PROFILE

An abstract graphic consisting of several concentric white circles of varying radii. Each circle has small white arrows pointing outwards from its circumference, creating a sense of motion or expansion. The circles are centered in the lower half of the page, partially overlapping the text.

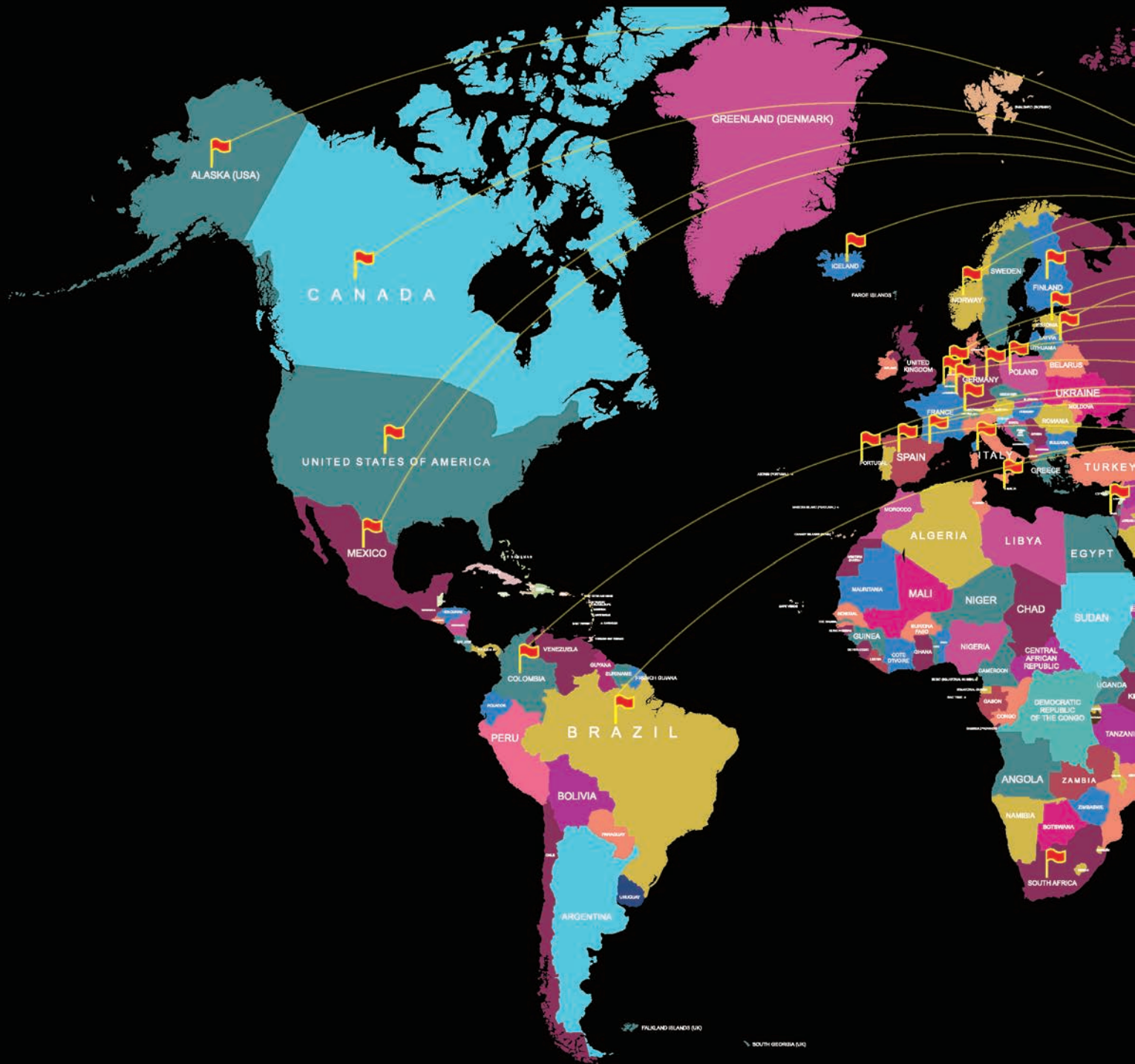

DISTRIBUTORS DETAILS



BRAND STORY

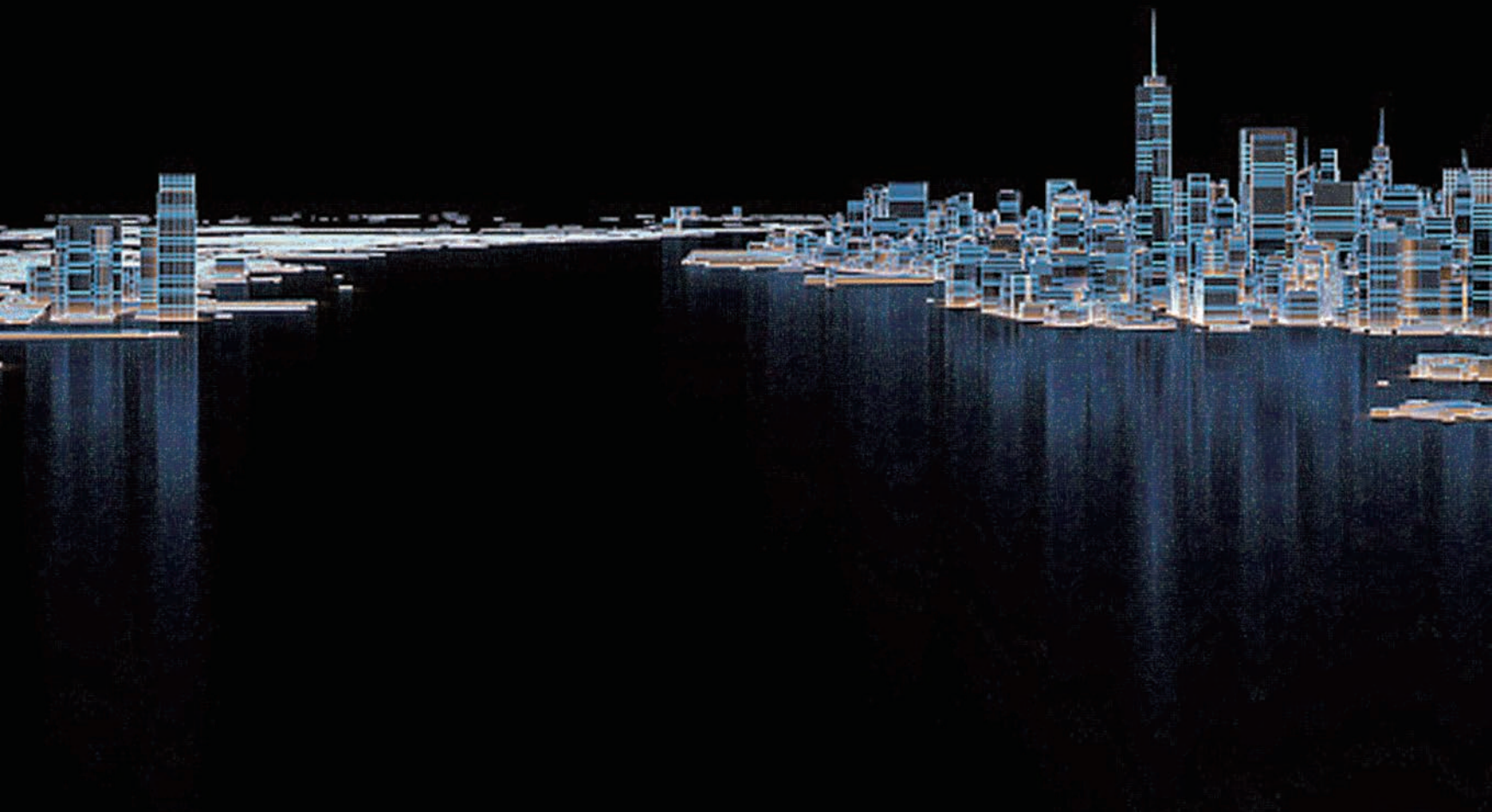



The headquarter of ABCMIX CO., LTD. is located in **Shenzhen**, China. We have been focusing on the fields of display props and smart signage since the founding of **2004**.

About the idea of our brand name **abcMIX** : 'abc' is the initial 3 letters of the Latin alphabet, 'mix' means **free-match** and blending, therefore our brand stands for creative **DIY**, free matching, **random mixing**, and interchangeable.

We have been providing solutions of standard, unified, and stable custom signage for global chain brands, and meanwhile, we have been developing a brand new, smart, free match & mix product. And by adhering to the theory of **'the simplest is the best'**, the ultimate goal of our new products is to redefine LED signage. Principles of our new products are ready-made, random mixing, installation easy, DIY creative, audio, lighting and video combining, to achieve a unique advantage in the market. Our purpose is to change the traditional custom signage to an international standardized, recognized and ready-made product. ABCMIX is to break the stereotype that LED signage has to be custom made, expensive, long production lead time, for business only, and to become popular in both commercial and personal, to make both business shops and family can enjoy our products.

We have total 40,000 square meters developing centers and workshops in Shenzhen and Hunan, China. Our company is both ISO9001 and ISO14001 certified. We invested more than 10 million US dollars on product development and automatic production lines. Our new products including magnetic fixing LED signage, track installation LED signage, pixel letter screen, double sided shop LED screen, CCT LED house numbers, smart LED advertising board, etc. Our products are globally **patented**, and recognized & certified by **UL, CUL, CE, KC, RoHS**, etc. Our products are currently selling to hundreds of countries, Germany, Italy, Spain, UK, France, Denmark, Russia, US, Canada, UEA, South Africa, Australia, Japan, Korea, Thailand, etc.

Looking into the future, **abcmix will stick to our principle of customer-oriented**, and to be the world's abcmix. We are now recruiting strategic partners worldwide, and are committed to achieve global brand coverage by 2022 and deploy outlets worldwide to enable rapid abcmix product delivery to users. Meanwhile, our R&D team will keep developing new products to meet and exceed the expectation from the market, and therefore to achieve our ultimate purpose: our products are available and useful for everybody.

COMPANY CULTURE





MISSION:
MAKE CREATIVITIES AND EXPRESSIONS EASIER



VISION:
TO BECOME THE ABCMIX OF THE WORLD

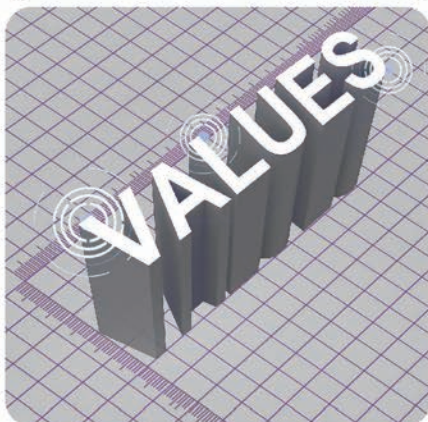

VALUES:
SIMPLICITY, INTEGRITY, SERVICE, AND GRATITUDE

HEADQUARTERS

📍 SHENZHEN

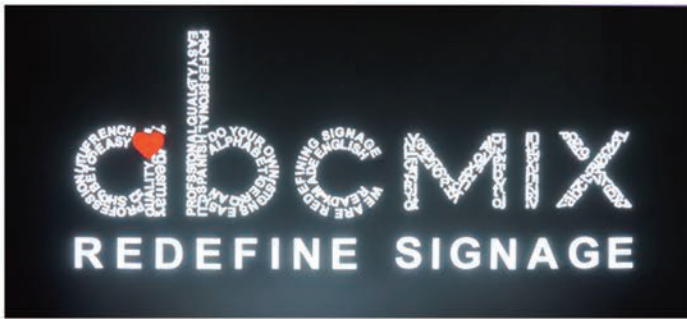

Our headquarters is located in Shenzhen, China. Since its establishment in 2004, we have been focusing on quality signage and display props. We have teams of design, research, manufacturing, sales and service etc.



Quality tooling

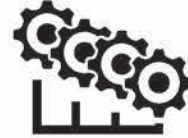

Robotic manufacturing
system



ISO 9001
certified control system



Data collecting
platform

abcMIX



Reliability test



Original design

PRODUCTION BASE

📍 Hunan, China



We set up a 20,000 square meters production workshops in Hunan. After investing over 10 million US dollars on robotic production workshops, our new factory in Hunan finally began to operate, and the estimated annual turnover will be around 80 million US dollars on general display props and quality signage.



218T-1000T Automatic injection machine



SMD workshop



SMT workshop



CNC



Assembly line



Aging testing

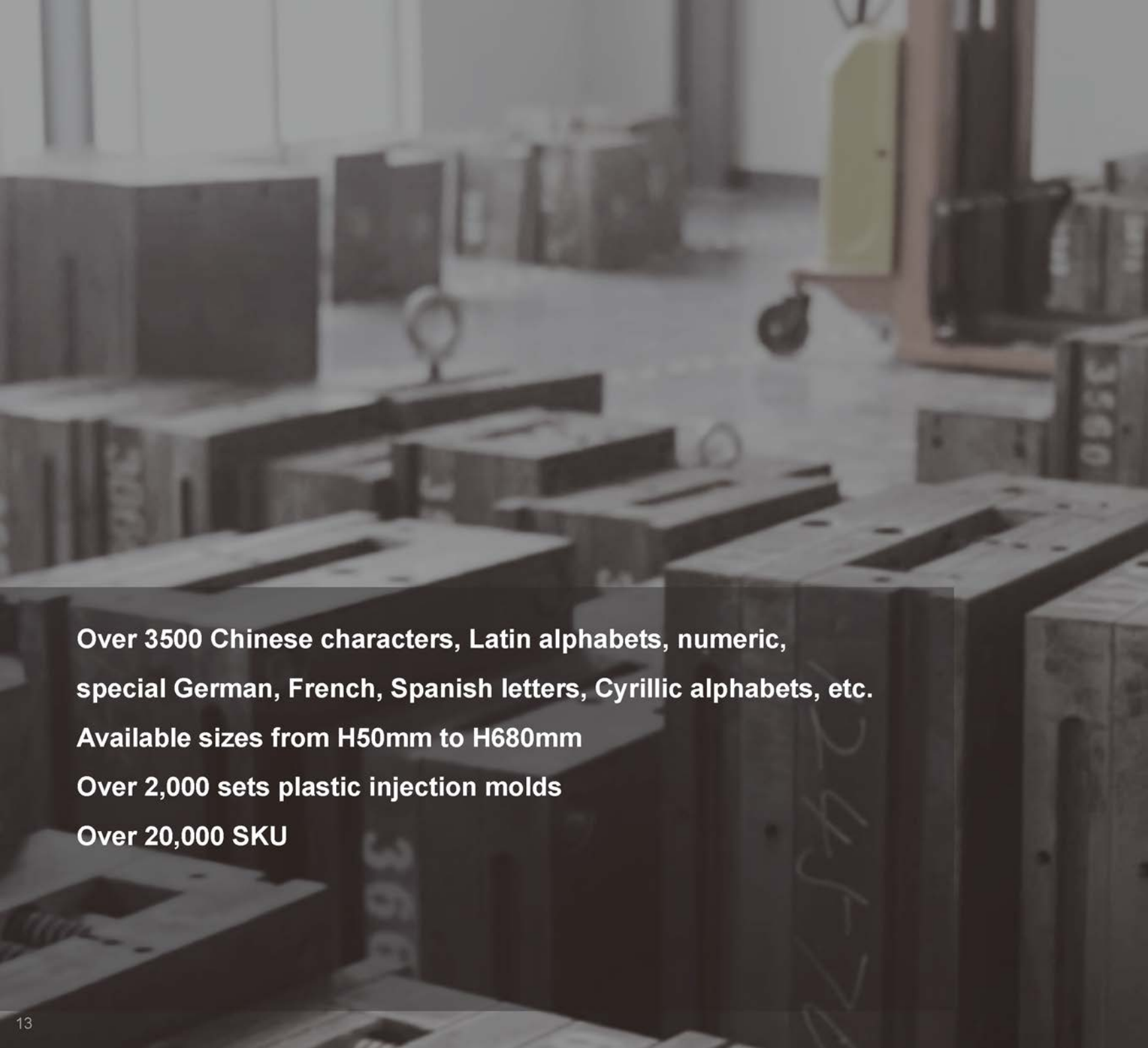

**Over 3500 Chinese characters, Latin alphabets, numeric,
special German, French, Spanish letters, Cyrillic alphabets, etc.
Available sizes from H50mm to H680mm
Over 2,000 sets plastic injection molds
Over 20,000 SKU**

Original design



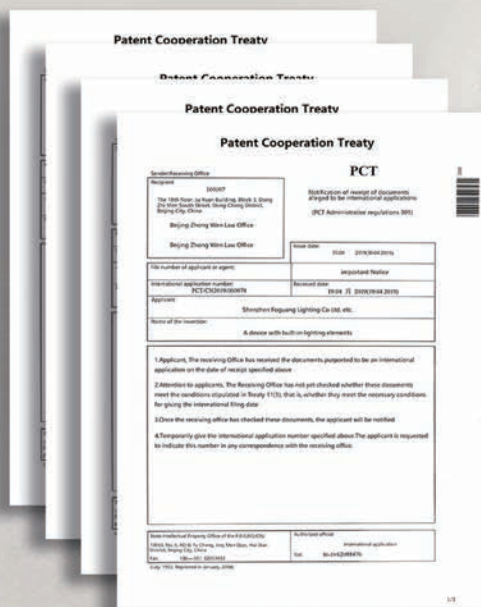
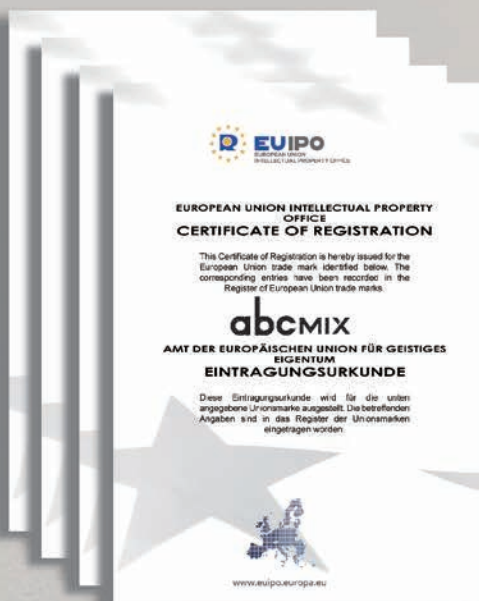
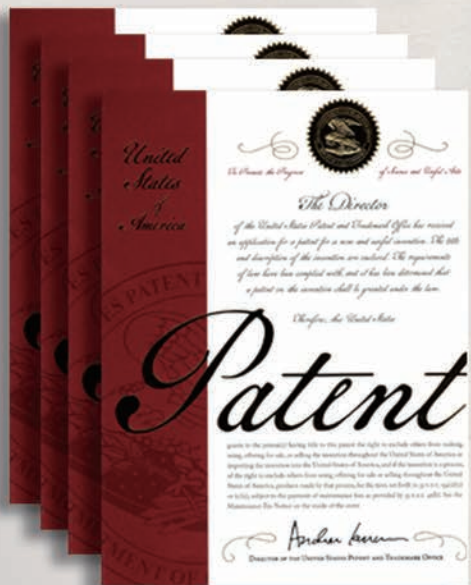

PATENTS AND CERTIFICATION



CERTIFICATE • CERTIFICADO • YARJUTESTING • ZERTIFIKAT • CERTIFICATE

Certificate of Conformity



Certificate No.: YRT201007216C
 Applicant: Shenzhen Fogaang Lighting Co., Ltd.
 Address: Building 5, Rows 2, The First Industrial Zone Of Jiaoting, Guangming Street, Guangming New District, Shenzhen City, China
 Manufacturer: Shenzhen Fogaang Lighting Co., Ltd.
 Address: Building 5, Rows 2, The First Industrial Zone Of Jiaoting, Guangming Street, Guangming New District, Shenzhen City, China
 Product: LED Letter Light Source
 Model: LED letter of circuit board light source series
 Brand Name: **abcMIX**

The submitted products have been tested by us with listed standards and found in compliance with the following European Directives:

The EMC Directive 2004/108/EC
 EN 55016: 2013
 EN 61547: 2009
 EN 61000-3-2: 2004+A1: 2009+A2: 2009
 EN 61000-3-3: 2013

The test was performed in normal operation mode. The test results apply only to the particular sample tested and to the specific tests carried out. This certificate applies specifically to the sample investigated in our test reference number only.

The CE marking as shown below can be affixed on the product after preparation of necessary technical documentation.

Other relevant Directives have to be observed.



Approved by: Department Manager
 July 21, 2015

SHENZHEN YARU TESTING CO., LTD.
 Address: No. 620 HaiYuan Commerce Center, No. 347 Xiliang Road, Xiliang Town, Bao'an District, Shenzhen City, P.R. China
 Tel: +86-755-27912980 Fax: +86-755-27919388 Website: www.yaru-test.com

Certificate of Compliance

Certificate Number: BCTC2007000931C

Applicant: abcmix co.,ltd
 Unit 503, Building 5, Alley 2, Jia Zi Tang Road, Jia Zi Tang Community, Feng Huang Street, Guang ming District, Shenzhen, China

Manufacturer: abcmix co.,ltd
 Unit 503, Building 5, Alley 2, Jia Zi Tang Road, Jia Zi Tang Community, Feng Huang Street, Guang ming District, Shenzhen, China

Product: Power supply module

MIN: abc-voltage tampering connector
 abc-Click dimmer

Trademark: abcmix

Test Standard: EN 55015:2013+A1:2015, EN 61547: 2009

The EUT described above has been tested according to the listed standards and found in compliance with the council EMC directive 2014/53/EU. The observations and test results referenced from this Certificate are relevant only to the sample tested. This Certificate is for the exclusive use of BCTC's Client and is provided pursuant to the agreement between BCTC and its Client. This Certificate is part of the full test report(s) and should be read in conjunction with report No.: BCTC2007000931E.

This certificate is for the exclusive use of BCTC's client and is provided pursuant to agreement between BCTC and its client. BCTC's responsibility and liability are limited to the terms and conditions of the agreement. The observations and test results referenced from this certificate are relevant only to the sample tested. This Certificate is part of the full test report(s) and should be read in conjunction with report No.: BCTC2007000931E.
 Tel: 400-788-0968 or 9150-330682
 Http://www.bctc-hk.com



Shenzhen BCTC Testing Co., Ltd. Report No.: BCTC1912000017E

TEST REPORT

Product Name: abcmix-Mix and match led signage
 Trademark: **abcMIX**
 Model Number: abcmix- AlphabeticNumericSymbolGeometric figure
 Prepared For: ABCMIX Co., Ltd.
 Address: Bld 5, Alley 2, Rd. Jia Zi Tang, Jia Zi Tang Community, Feng Huang Str., Guangming District, Shenzhen, 518132, China
 Manufacturer: HunanHamao Intelligent Technology Co., Ltd.
 Address: Building 5, 6, and 14 of Section 1, 1, Kuchuang Industrial Park, Lighthouse Road, Economic Development Zone, Qiyang County, Yongzhou City, Hunan Province
 Prepared By: Shenzhen BCTC Testing Co., Ltd.
 Address: BCTC Building 8 1-2F, East of 8 Building, Pengzhou Industrial, Fujian 1st Road, Chabou Community, Fuyong Street, Bao'an District, Shenzhen, China
 Sample Received Date: Dec. 18, 2019
 Sample tested Date: Dec. 19, 2019 to Jan. 02, 2020
 Issue Date: Jan. 03, 2020
 Report No.: BCTC1912000017E
 Test Standards: CISPR 15:2018
 IEC 61000-4-2:2008, IEC 61000-4-3:2010
 Test Results: PASS

Compiled by: Kelsey Tan
 Reviewed by: Eric Yang
 Approved by: Department Manager

The test report is effective only with both signature and specialized stamp. This report is for the report refer only to the sample(s) tested. Without written approval of Shenzhen BCTC Testing Co., Ltd. this report can't be reproduced except in full. The tested sample(s) and the sample information are provided by the client.

Test Report Tel: 400-788-0968 Web: http://www.bctc-hk.com BCTC RF EMC 009 005 Ver.: A.0 Page 1 of 25

CERTIFICATE • CERTIFICADO • YARJUTESTING • ZERTIFIKAT • CERTIFICATE

Certificate of Conformity



Certificate No.: YRT201007222C
 Applicant: Shenzhen Fogaang Lighting Co., Ltd.
 Address: Building 5, Rows 2, The First Industrial Zone Of Jiaoting, Guangming Street, Guangming New District, Shenzhen City, China
 Manufacturer: Shenzhen Fogaang Lighting Co., Ltd.
 Address: Building 5, Rows 2, The First Industrial Zone Of Jiaoting, Guangming Street, Guangming New District, Shenzhen City, China
 Product: Injection Molding Shell
 Model: Injection Molding Shell
 Brand Name: **abcMIX**

The submitted products have been tested by us with listed standards and found in compliance with the following European Directives:

The RoHS Directive 2011/65/EU:
 IEC 62321-4: 2013;
 IEC 62321-6: 2013;
 IEC 62321: 2008;
 EN 14372:2004; EPA 3540C:1998

The test was performed in normal operation mode. The test results apply only to the particular sample tested and to the specific tests carried out. This certificate applies specifically to the sample investigated in our test reference number only.

The RoHS marking as shown below can be affixed on the product after preparation of necessary technical documentation.

Other relevant Directives have to be observed.

RoHS

Approved by: Department Manager
 July 21, 2015

SHENZHEN YARU TESTING CO., LTD.
 Address: No. 620 HaiYuan Commerce Center, No. 347 Xiliang Road, Xiliang Town, Bao'an District, Shenzhen City, P.R. China
 Tel: +86-755-27912980 Fax: +86-755-27919388 Website: www.yaru-test.com

Verification Report

No. H08EC190310901 Date: 02 Jul 2018 Page: 1 of 16

SHENZHEN FOGAANG LIGHTING CO., LTD.
 8TH FLOOR, BLD 8 ALLEY 2, JIA ZI TANG ROAD, JIA ZI TANG COMMUNITY, FENG HUANG STREET, GUANG MING DISTRICT, SHENZHEN, P.R.C

Sample Name: abcmix
SGS Job No.: NP19-001100 - NP
Tested Basic Model No.: abcmix-ABCDEF@HJKLMNOPQRSTUWXYZ0123456789-45abcdefghijklmnopqrstuvwxyz
Date of Sample Received: 28 May 2019
Verification Period: 28 May 2019 - 28 Jun 2019

Verification Requested: With reference to RoHS Directive (EU) 2011/65/EU amending 2011/65/EU
Verification Method: Please refer to next page(s).
Verification Result: Please refer to next page(s).
Verification Conclusion: Based on the verification results of the submitted samples, the results of Lead, Mercury, Cadmium, Hexavalent chromium, Polychlorinated biphenyls (PCBs), Polychlorinated dibenzofuran (PCDFs) and Phthalates such as Bis(2-ethylhexyl) phthalate (DEHP), Bis(2-propyl) phthalate (BPP), Dibutyl phthalate (DBP), and Dioctyl phthalate (DOP) comply with the limits as set by RoHS Directive (EU) 2011/65/EU amending Annex 6 to Directive 2011/65/EU.

Signed for and on behalf of
 SGS-CSTC Standards Technical Services Co., Ltd. Ningbo Branch

Jiro Kaw
 Job No. Approved Signatory

SGS is a registered trademark of SGS Group (SIA) in Singapore. The SGS logo is a registered trademark of SGS Group (SIA) in Singapore. The SGS logo is a registered trademark of SGS Group (SIA) in Singapore.

CERTIFICATE • CERTIFICADO • YARJUTESTING • ZERTIFIKAT • CERTIFICATE

Certificate of Conformity



Certificate No.: YRT201007217C
 Applicant: Shenzhen Fogaang Lighting Co., Ltd.
 Address: Building 5, Rows 2, The First Industrial Zone Of Jiaoting, Guangming Street, Guangming New District, Shenzhen City, China
 Manufacturer: Shenzhen Fogaang Lighting Co., Ltd.
 Address: Building 5, Rows 2, The First Industrial Zone Of Jiaoting, Guangming Street, Guangming New District, Shenzhen City, China
 Product: LED Letter Light Source
 Model: LED letter of circuit board light source series
 Brand Name: **abcMIX**

The submitted products have been tested by us with listed standards and found in compliance with the following FCC Rules and Regulations:

The FCC Standard:
 FCC Part 15, ANSI C63.4-2003

The test was performed in normal operation mode. The test results apply only to the particular sample tested and to the specific tests carried out. This certificate applies specifically to the sample investigated in our test reference number only.

The FCC marking as shown below can be affixed on the product after preparation of necessary technical documentation.

Other relevant Directives have to be observed.

FCC

Approved by: Department Manager
 July 21, 2015

SHENZHEN YARU TESTING CO., LTD.
 Address: No. 620 HaiYuan Commerce Center, No. 347 Xiliang Road, Xiliang Town, Bao'an District, Shenzhen City, P.R. China
 Tel: +86-755-27912980 Fax: +86-755-27919388 Website: www.yaru-test.com

A stylized globe composed of a network of white dots and lines, set against a dark background with a bright light source on the left. The globe is formed by a dense grid of small dots on the left side, which transitions into a sparser network of larger dots connected by thin lines on the right side. The overall effect is that of a digital or data network. A bright light source on the left creates a lens flare and illuminates the globe from that direction.

EXHIBITIONS

Have held over **50⁺**
international exhibitions

Signed over **100⁺**
distributor partners

We have held over 50 international exhibitions during 2019 and 2020 in the field of signage, lighting, retail fixture and building material etc. and signed a lot of strategic partners since the beginning. Our exhibition booth has always been the focal point, attracting visitors like end users, business users, sign makers, trading companies, lighting manufacturers, etc. Now we are selling abcmix to more than 100 countries, for example, USA, Canada, Germany, Italy, Spain, UK, France, Denmark, Slovak, Russia, UEA, South Africa, Kenya, Australia, Japan, Korea, Thailand, etc.



2019-4 HONGKONG

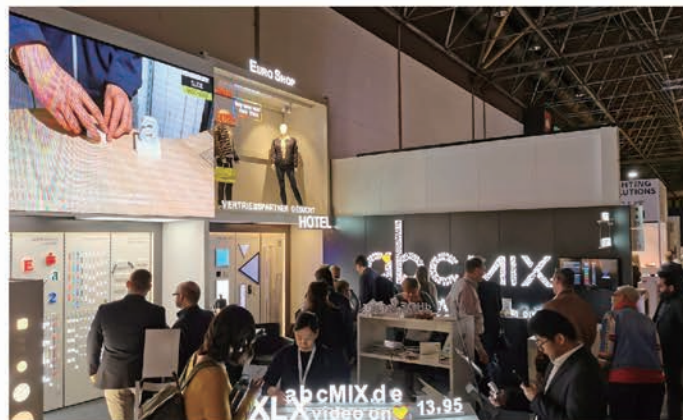

2019-4 Germany



2019-6 South Africa



2019-7 Poland



2019-8 Germany



2019-9 Spain



2019-9 India



2019-12 South Korea



2019-10 GUANGZHOU

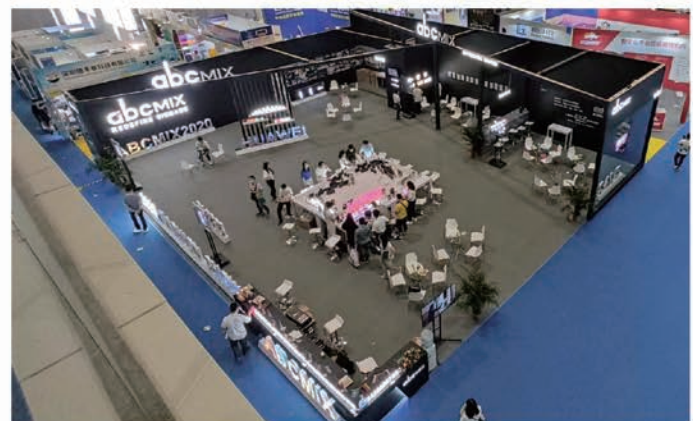

2020-9 SHENZHEN

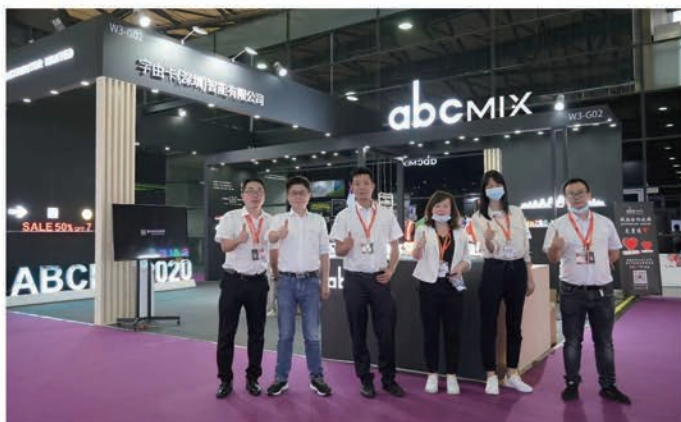

2020-9 SHANGHAI



2020-9 XIAMEN

VIS





PRODUCT INTRODUCTION

The background of the slide is a dark, almost black, space filled with a dense collection of 3D-rendered symbols and characters. These symbols, including numbers (1-9, 0), letters (A-Z), and special characters like the dollar sign (\$), percent sign (%), hash sign (#), and at sign (@), are all rendered in a glowing, multi-colored outline style. The colors of the outlines transition through a spectrum from blue and purple to green and yellow, giving the symbols a vibrant, neon-like appearance. The symbols are scattered across the entire page, creating a complex, textured background that contrasts sharply with the large, white, sans-serif text of the title.

abcMIX

READY-MADE · EASY · THE COMBINER

DIY:00001



WELCOME

abcMIX
REDEFINE STORAGE

Contents
Replaceable

HELLO

AAAAA

WOW

CREATE YOUR SIGN

MIX & MATCH LED SIGNS A to Z

A B C D
E F G H
I J K L M
N O P Q
R S T U
V W X Y Z

DIY DIY I U

NEW
DIY SIGN

3D Sign

12a

Product introduction:



Magnetic series
Counter/wall application



Track series
Suspension application



P3 letter display series
Freestanding



Double-sided signboard display series
IP65 Horizontal/suspension application



LED Advertising Board
Suspension application



Wall letter series
IP65 wall application



Rechargeable Desktop
Lightbox Display

More is coming...



Magnetic series
Counter/wall/window application



Magnetic series



This is our most popular products. You don't need any tools to do the installation, very easy and convenient. It can apply to any occasions—both business and personal; you can even take out for outdoor events. It's a mind blowing invention in the LED signage industry; no need to go through lengthy customization to brighten up the business shops. It's a product of random combination, and the contents are changeable at will.



AVAILABLE SIZES

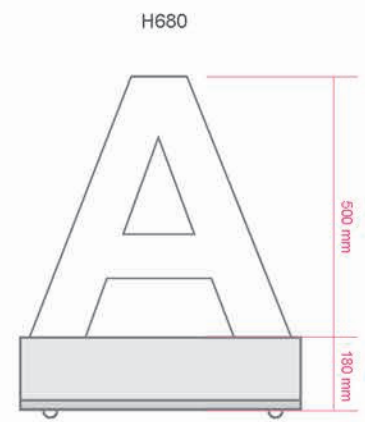
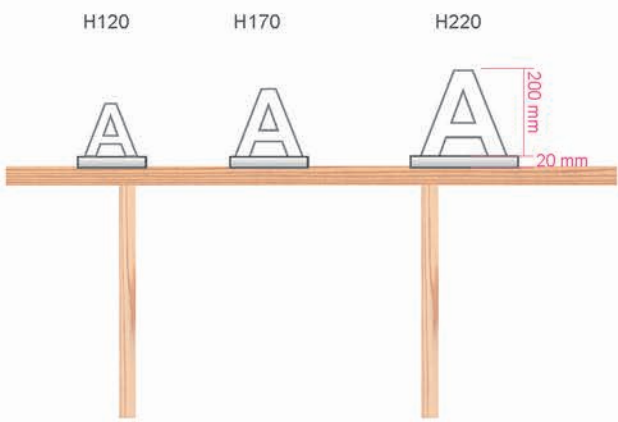
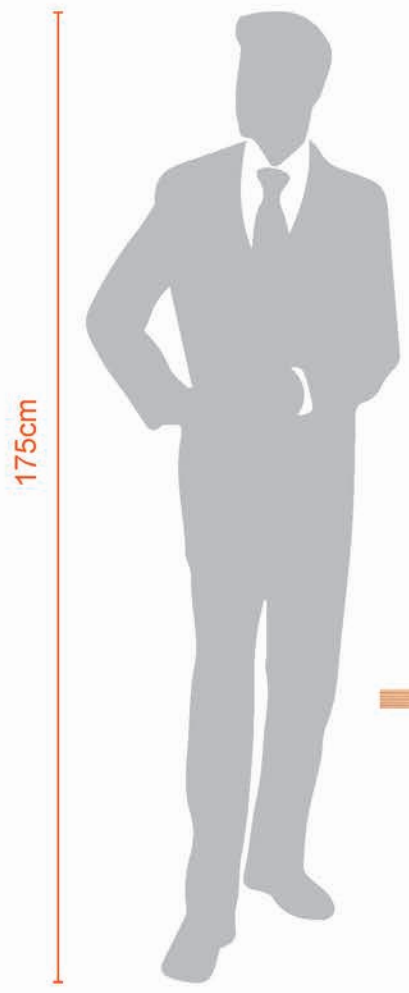



Material of magnetic signs including PC diffusion panel, aluminum PCBA, LED, plastic ABS housing, and intensified magnets etc. Different products and different batches have the same brightness, same color temperature, same specification and same quality.



Poly carbon diffusion panel

Sign form lighting system

Plastic ABS housing

Intensified magnet

Gold plating spring conductor pins



How to use

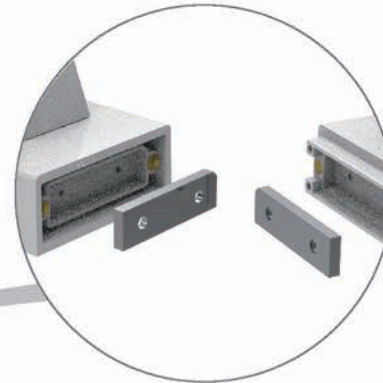
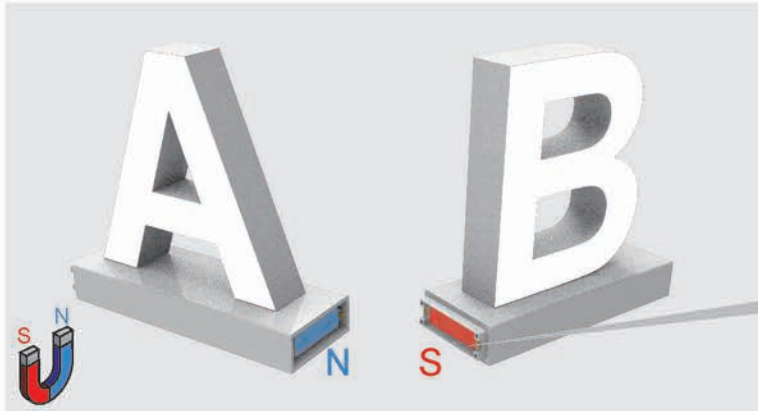

At the end of each base, installed with 2 pieces intensified magnets

As the picture shows, when you combine 2 signs, the magnets will automatically attach the combination



As the picture shows, at the end of each base, installed with 2 pieces intensified magnets





Magnetic series

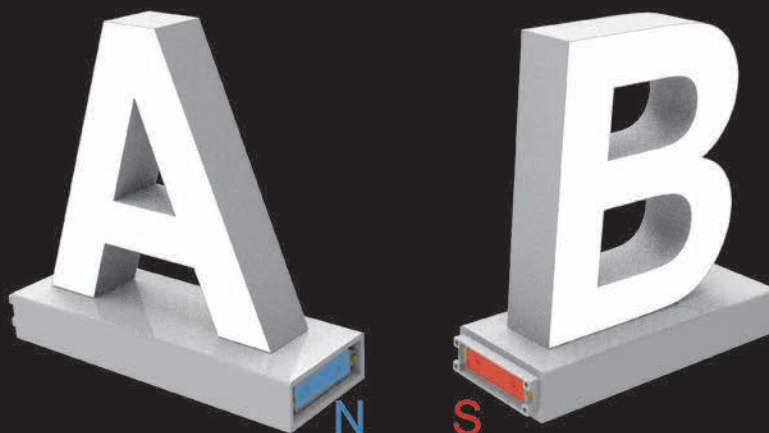

The automatic magnetic attraction makes the installation become easy and convenient.

Indoor power supply



Mobile phone charger / 5V 2A



DC driver / DC12V (3-5A)



L35mm multi ports input touch dimmer

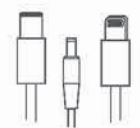

Portable power supply



In car driver / 5V 2A



Big capacity batteries / USB 5V 2A / DC12V(3-5A)



Power bank / 5V 2A



L35mm multi ports input touch dimmer

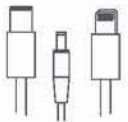

Accessories



Standard spacers

Available size is 55mm and 105mm.



Curved spacer

You can use the curved spacer to bend your sign words at a 90° angle. If you use 4 pieces curved spacers, you can face your signs to all four directions.

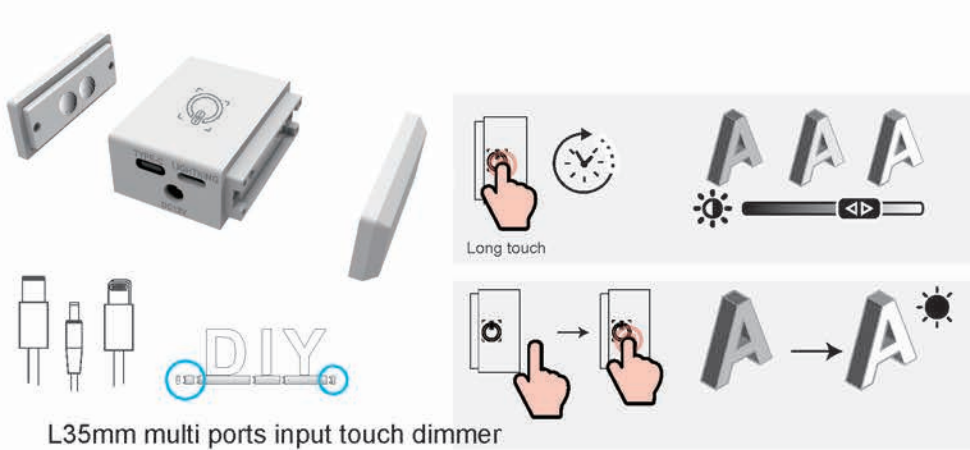

L35mm multi ports input touch dimmer

Length is 35mm. It also equipped with built-in switch and dimmer: long touch for dim down or intensify up, short touch for on/off switch. Moreover, it has built-in input ports for Type C, Lightning and DC driver.



L125mm Magnetic Cell Module

This power bank connector equipped with 2 pieces built-in 18650 batteries.

Power supply modes

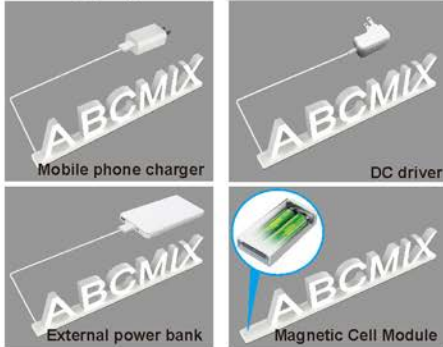

Data sheet of the dimmer				
SN	Power supply mode	Dimming range (LX)		Dimmer mode
		Maximum	Minimum	
1	DC driver DC12V(3A-5A)	28000	6200	Touch CVT dimmer
2	Mobile phone charger Type-C 5V 2A	11000	5500	
3	Mobile phone charger Lightning 5V 2A	11000	5500	
4	L95mm Magnetic Cell Module	10000-12000		Not applicable

Test equipment: SENTRY(ST520), Products tested: H100mm"BCDEF" lighted up simultaneously, color temperature: 6000-6500K. Above for reference only.

Instruction of the Magnetic Cell Module

Data sheet of the Magnetic Cell Module -----

Magnetic Cell Module

Battery: 18650
 Type: Li-ion
 Capacity: 3400mAh X 2pcs
 input 5V---2A
 Output 9V
 Discharging Capacity: 15WH

Charging time: 4 hours
 Take H120mm "A" for example
 Discharging time:
 3 letters-----7 hours
 4 letters-----6 hours
 5 letters-----5 hours
 6 letters-----4 hours
 7 letters-----3.5 hours
 8 letters-----3 hours



Because of air delivery restrictions, the product is not equipped with batteries. End users can buy 18650 3.7V batteries from local market. To avoid damage to the products due to unstable current, please do not use batteries of different levels, brands and output voltage. Above charging time is for reference only. There will be differences because of environment conditions and battery brand. Please use batteries as suggested, and make sure the battery length is no longer than 66.5mm

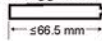

Manual: -----

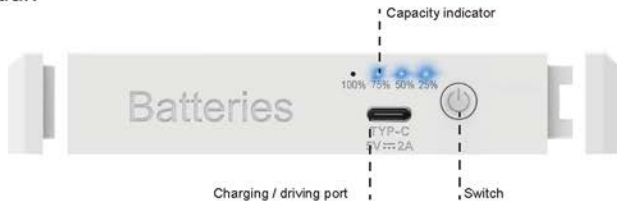

Manual -----

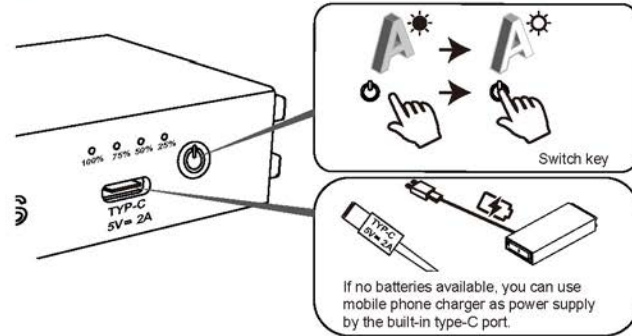

Example of application:



Shelves for wall

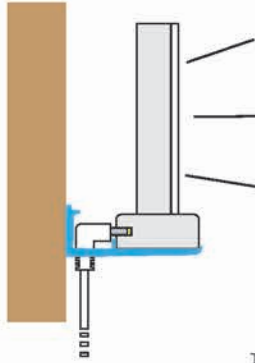

Shelves for wall

The shelves come with 3M stickers, but you can also use screws to reinforce the fixing. This is a convenient accessory, with fall proof design. Please use DC driver with "7" shape connector.



Magnetic series

Shelves for glass windows

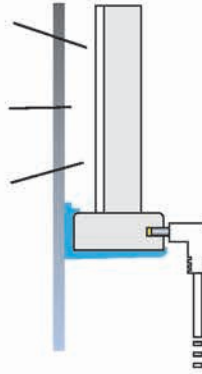

Magnetic series

Shelves for glass windows

The shelves come with 3M stickers, also with fall proof design. It's for glass window / door purpose, easy installation, both classic and elegant.





Magnetic series

Pillars shelves

Pillar shelf W525mm

This transparent shelf was designed for standard pillars with easy locking system.

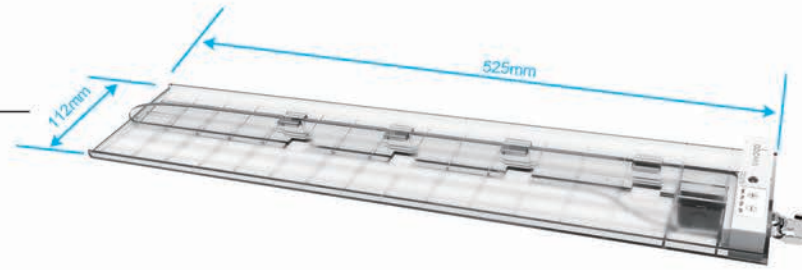

Pillar shelf W415mm

This transparent shelf was designed for standard pillars with easy locking system.

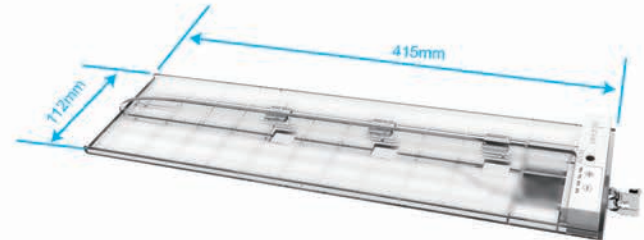

Manual

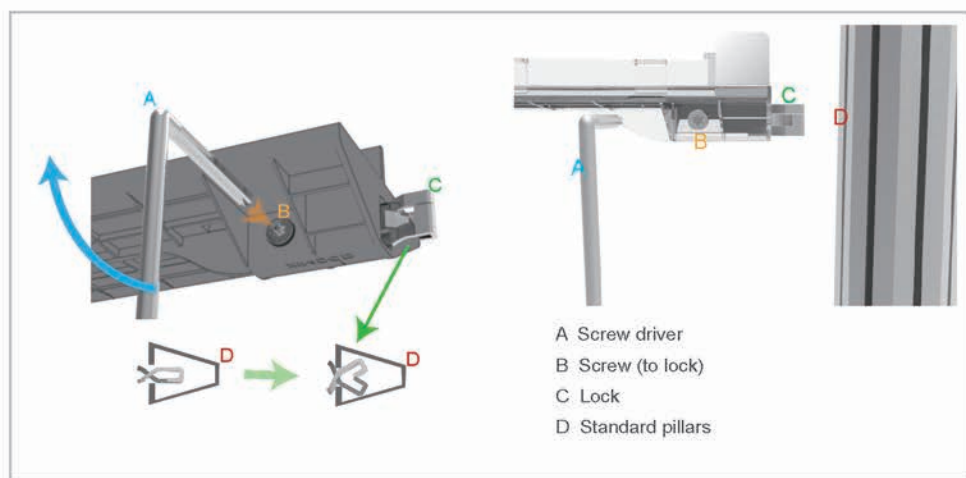
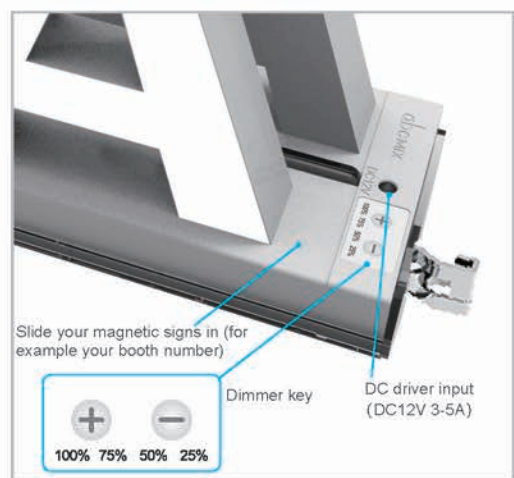



Magnetic series



Exhibition stand



Warehouse

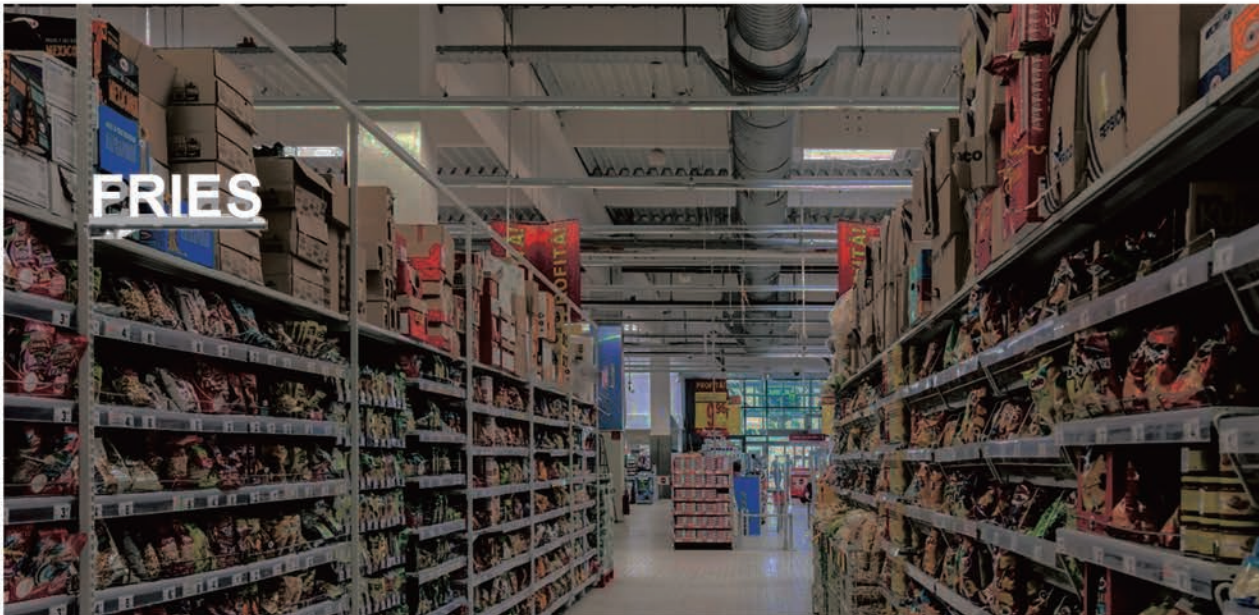

Supermarket

Magnetic Top Track Installtion LED Sign

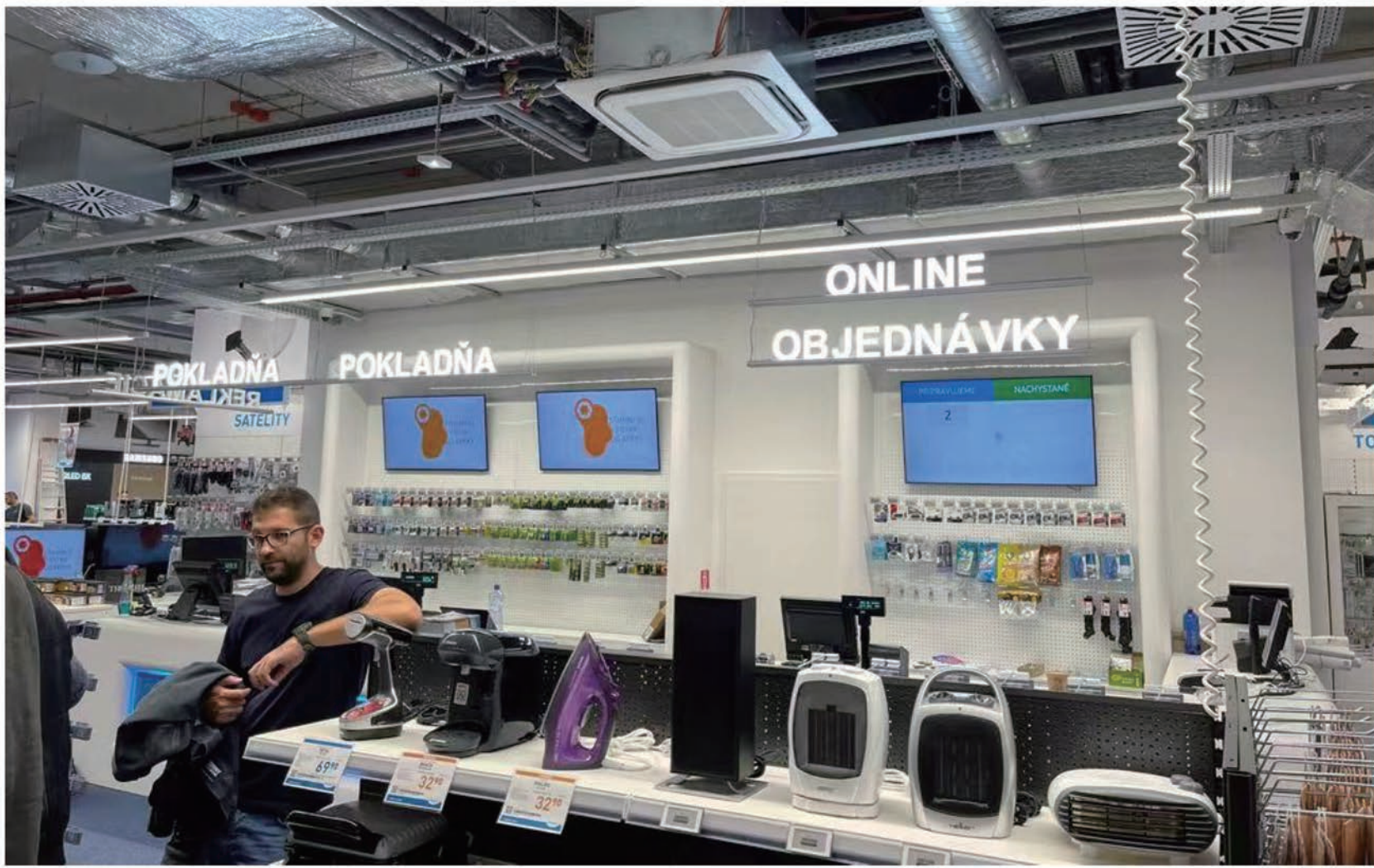



If you want a logo or a special visual on your signs (especially for 220mm circle and square), you can contact our local partner to customize.

Customize a UV printing



Magnetic Counter Display Round / Square

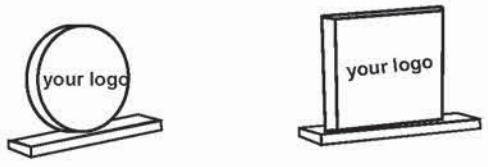

Size: 135、220mm





Send us your design or a file



UV printing

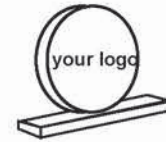

Done



This is an example we did for a wine brand. With UV printed visuals makes your office or shops looks special and attractive.



Magnetic series

3D LED display

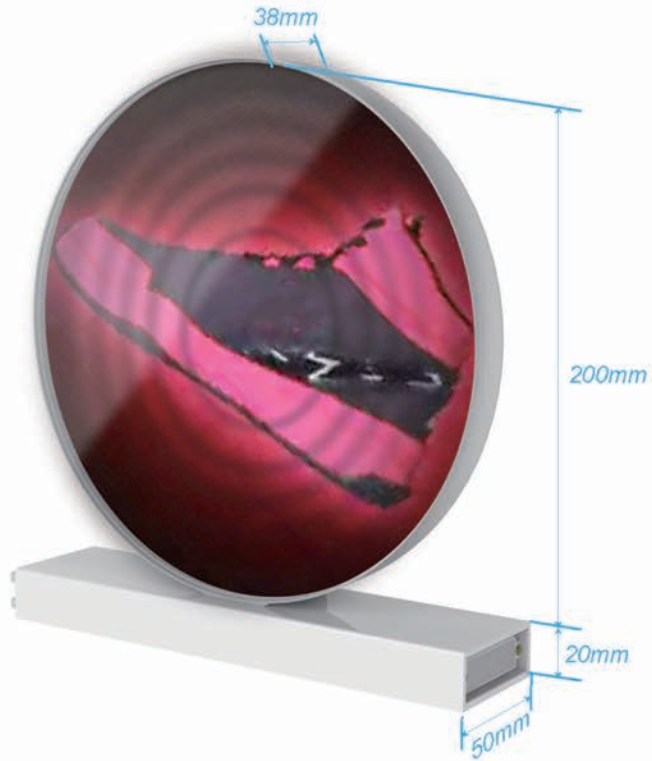

- Elements:
1. DC driver
 2. Magnetic connector
 3. 3D LED display and magnetic signs

You can upload your videos and pictures to the display by mobile phone app.



We integrated the popular product "Holographic LED screen" into our magnetic signs. If you want your signs to be 3D video, this product will be a nice choice. It can random combine with our current magnetic signs, which will make your office or shops special and attractive.



Magnetic series

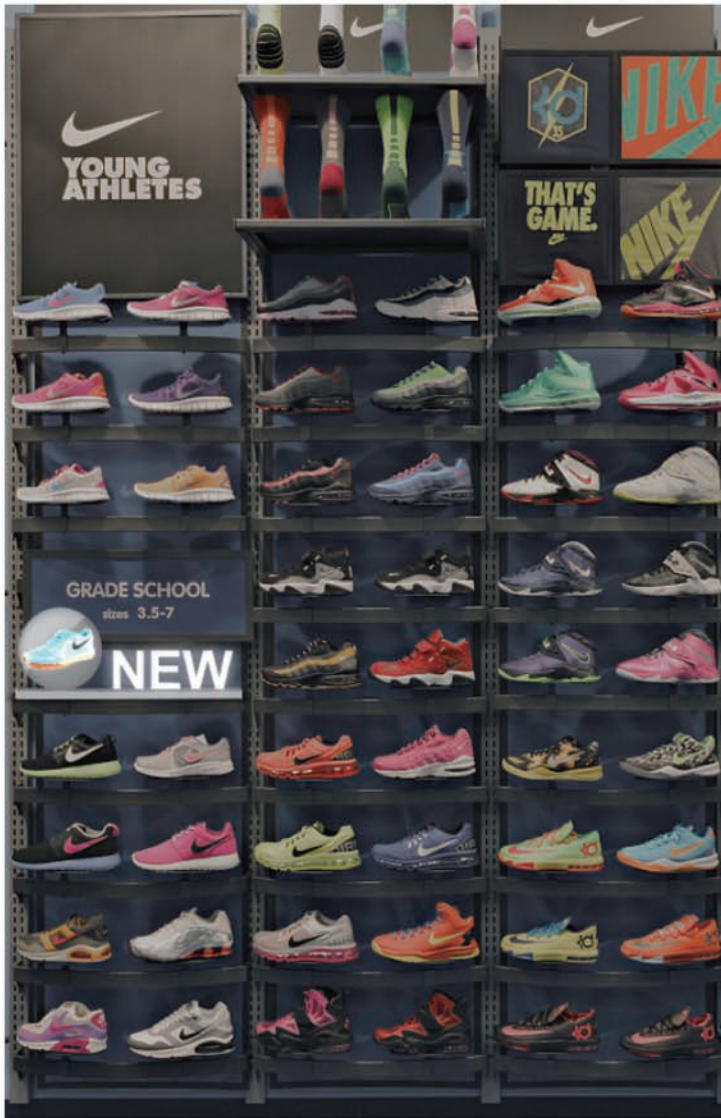

Application examples

1. 360° display for shoes
2. LOGO display in a BMW auto store
3. Advertisement of a coffee brand
4. Advertisement of a beer brand
5. Advertisement of a watch brand





Magnetic series

Signs of random combination

Our LED signs are not just limited to letters. You can also group a lot of symbols and special items into them to make the occasions more enjoyable. For example, you can add a Christmas tree figure into a group of promotion signs, to make the scene more pleasing to customers and increase their desire to buy.



Letters combine with a Christmas tree figure.





Letters combine with personalized printing patterns.



Letters combine with a logo printed take away coffee cup (3D 360°).



Letters combine with a red heart figure.



Letters combine with a logo printed coffee cup.





Magnetic series

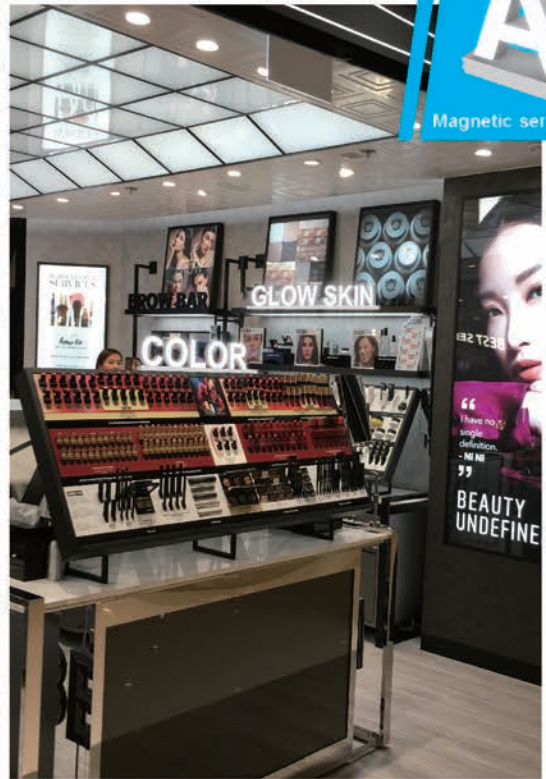

Our magnetic signs can apply to various scenes and any business occasions. With our easiest installation design and minimal customization, you can have a promotion sign in no time.



Magnetic series



Our largest magnetic LED sign is H680mm.
You can apply them to some spacious scenes. When the light is put on, it's very mind blowing.

You can apply this series to exhibition booth, wedding ceremony, reception and show window etc.





Magnetic series



Our magnetic signs are also good for rental. For example, a cake shop can have a few sets of our products and rent "HAPPY BIRTHDAY" or other words to customers

In exhibition, showrooms or shops, you can use our magnetic signs to spell the product model number, which can save a lot of trouble when your products are upgraded: just replace the new model number, no need to replace the whole signs.

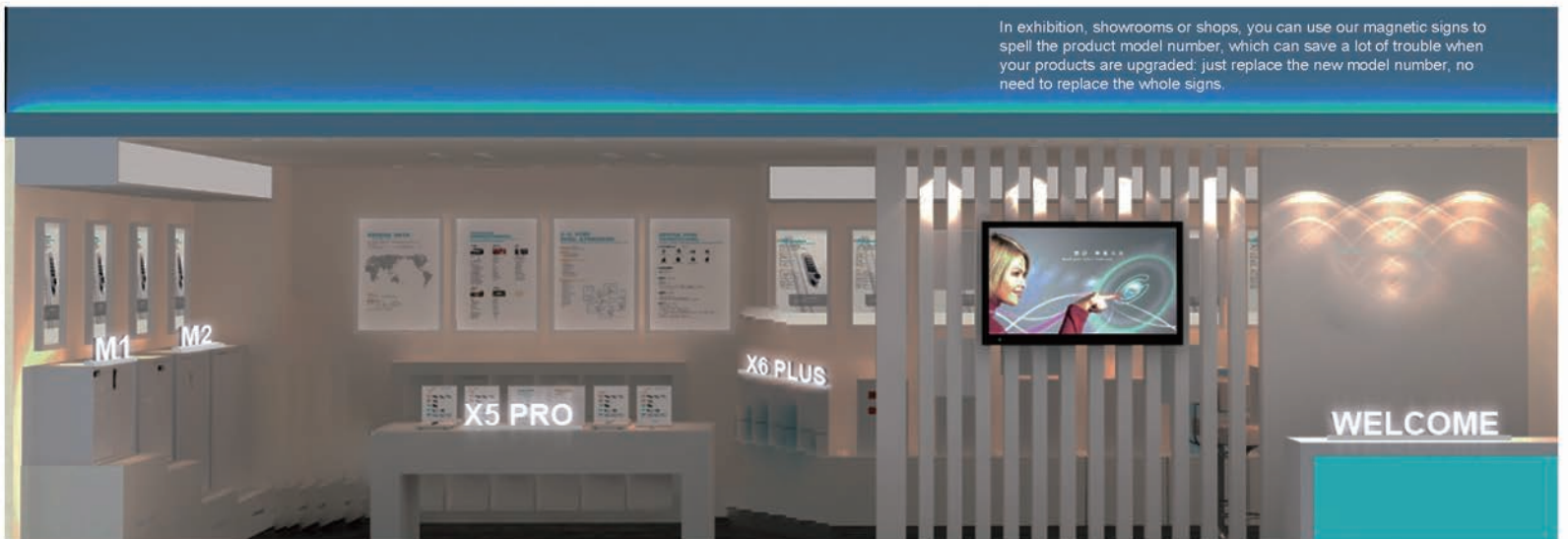



Magnetic series

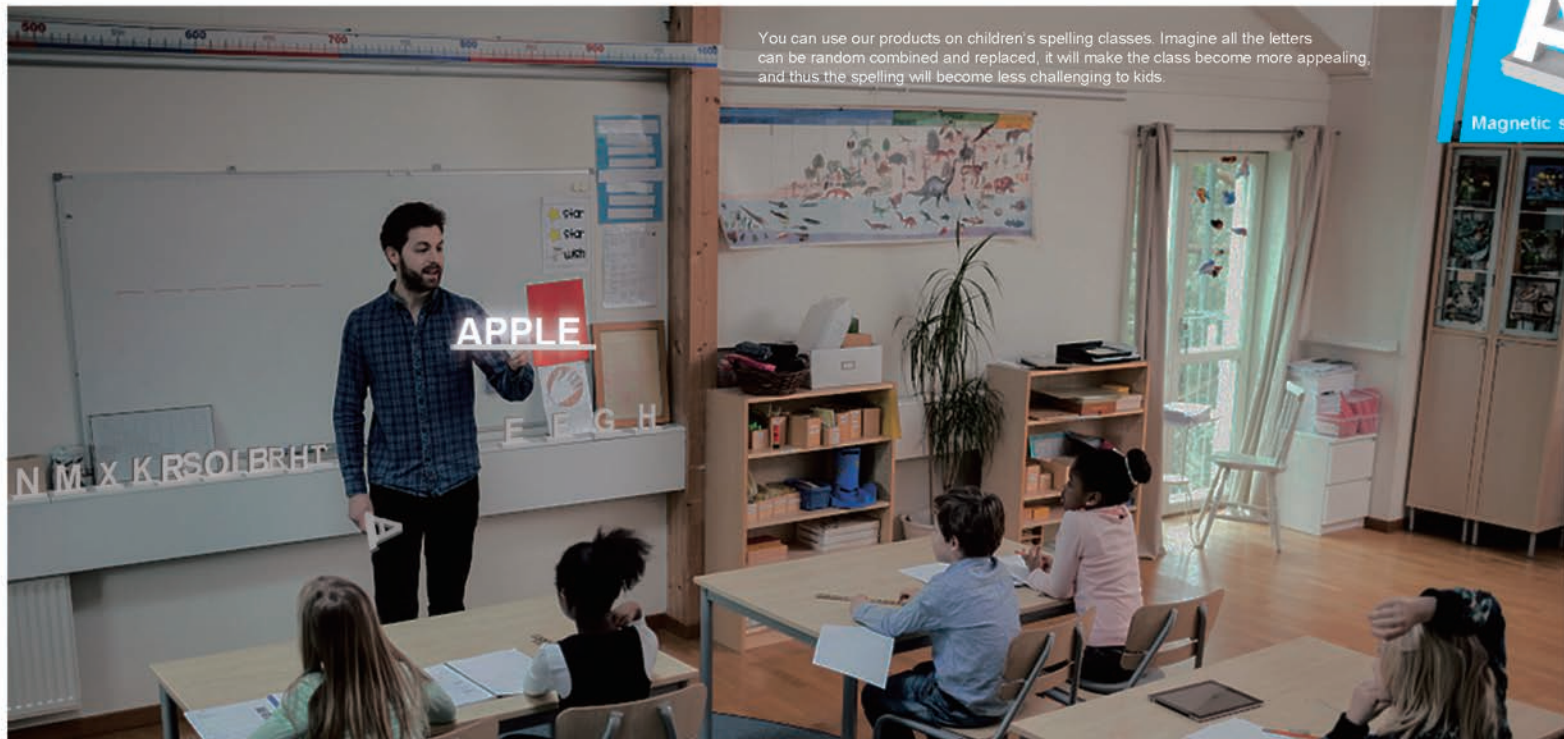

You can use our products on children's spelling classes. Imagine all the letters can be random combined and replaced, it will make the class become more appealing, and thus the spelling will become less challenging to kids.

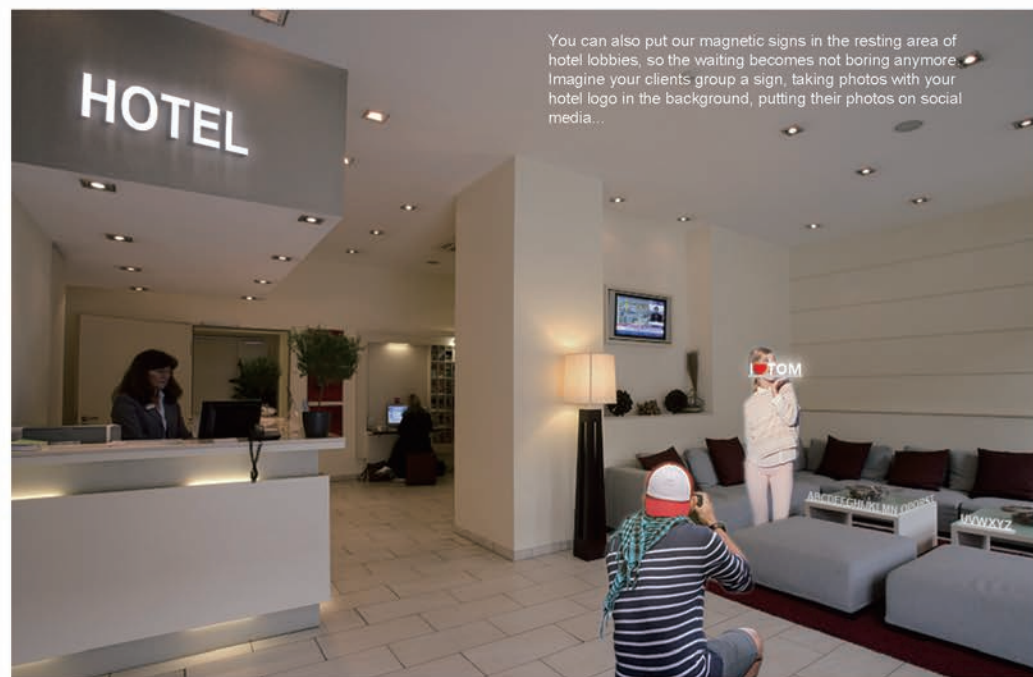

You can also put our magnetic signs in the resting area of hotel lobbies, so the waiting becomes not boring anymore. Imagine your clients group a sign, taking photos with your hotel logo in the background, putting their photos on social media...



You can put our signs in the window shield of your car. It can share the same power supply of the cigarette lighter.



Magnetic series



Our products only take limited space. You can put them onto glass windows, counter, wall and top of furniture etc. You can also group different size letters together.



Magnetic series



During some events for example The World Cup, you can use our products for direction, which will make the visitors appreciate the hospitality and considerateness of the city more.

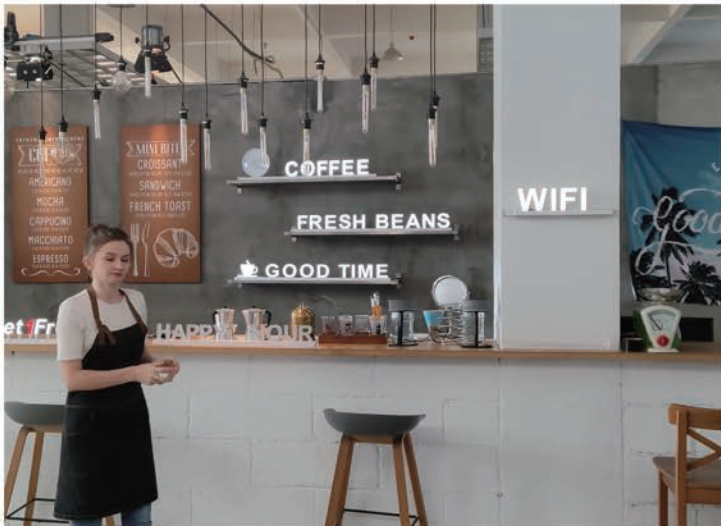

In whatever occasions, our products can serve as both advertising and eye catcher.

Create your sign



Create your sign

Our products can also serve as gifts. You can contact our sales for a special package, which will make your intension seems more considerate and artistic.





Rechargeable Table Stand POP Film Holder



Installation instruction

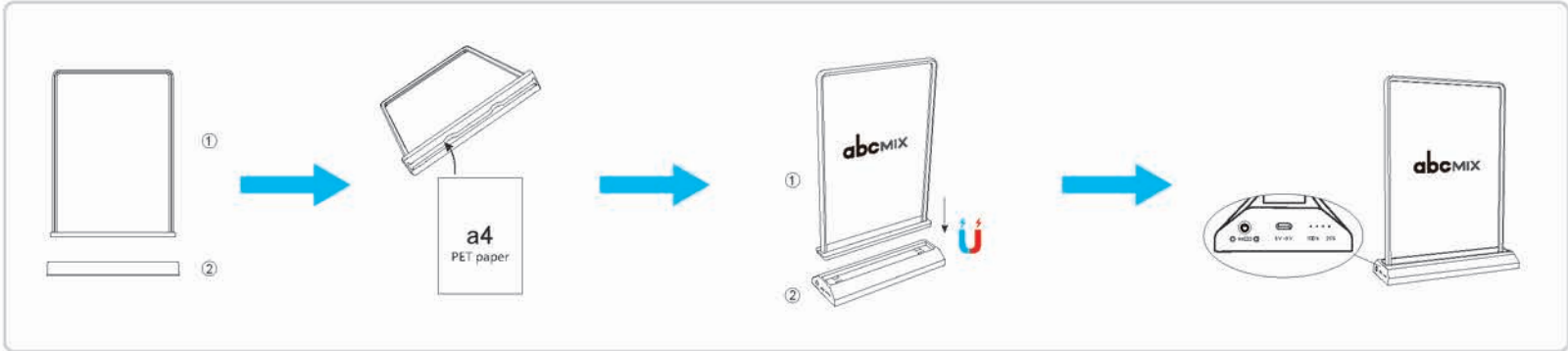



Rechargeable Table Stand POP Film Holder

8hrs power duration, 1minute POP replacement, 10000mA li-ion battery

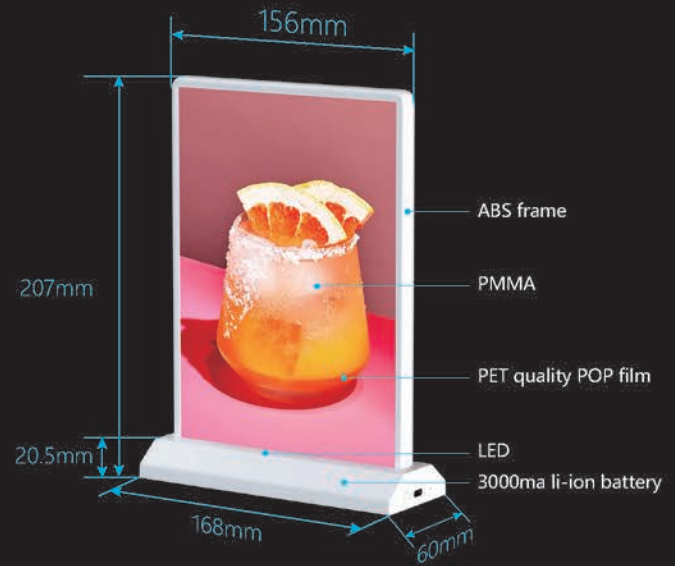
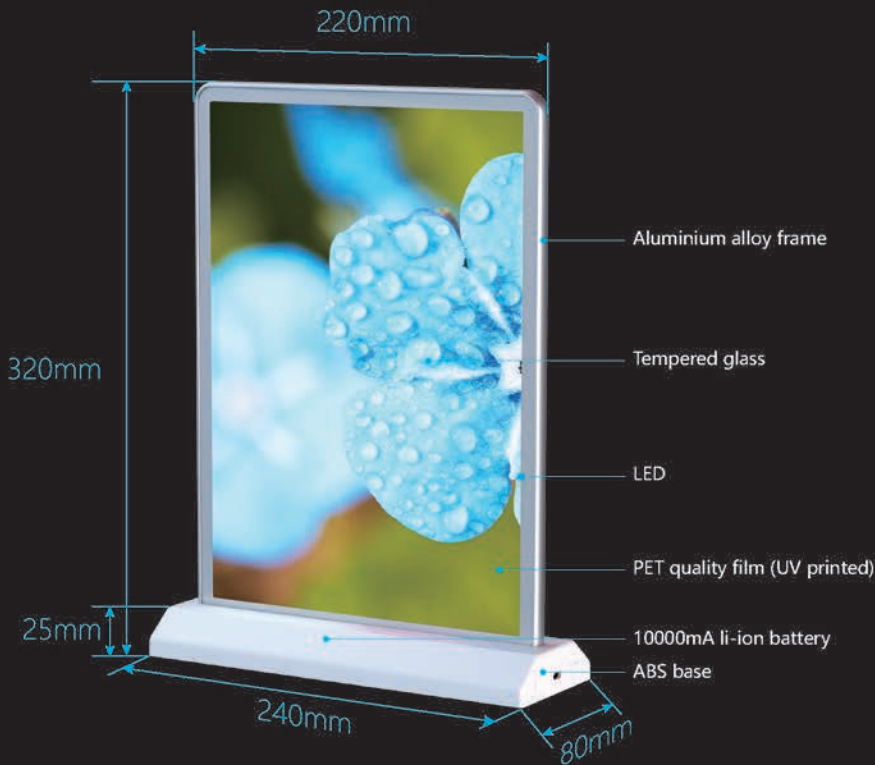

Available size: A4 and A5



Applied for shop,comany, conference, meeting, hotel,club,signs,counter, display, advertisement

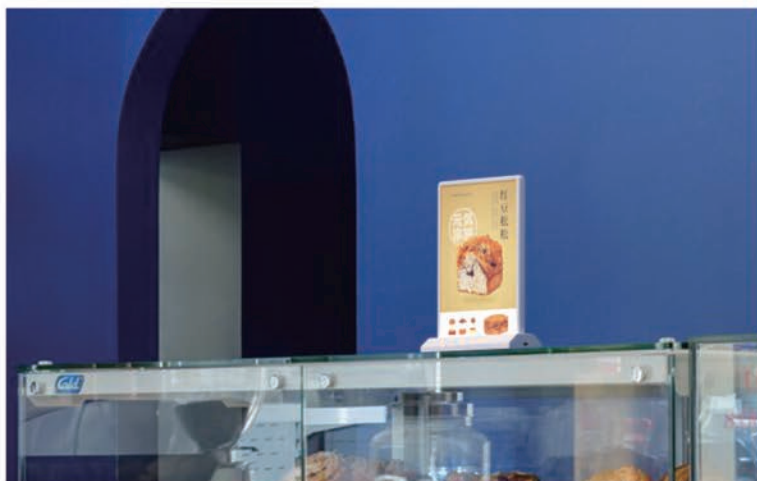



Suspending Ultra-slim Light Box

Suspending Ultra-slim Light Box

Super bright
Fast POP replacement



Installation instruction

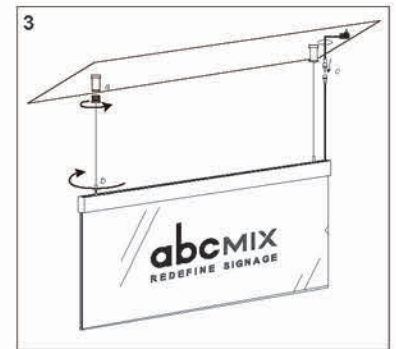
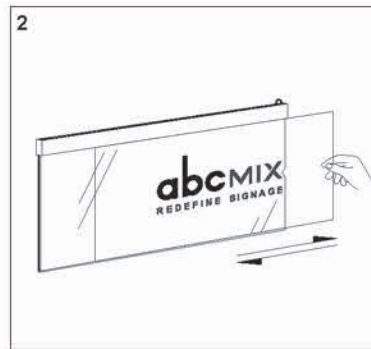
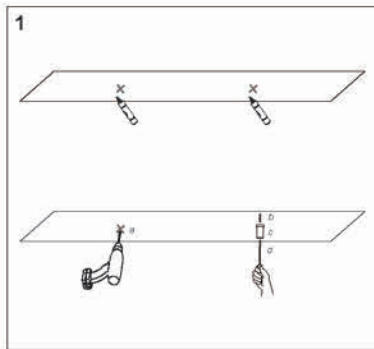

Scenarios of product

Shop, company, conference, hotel, club
Signs, counter, presentation, advertisement



The same city

XXX is a company specialized in materials and related products for the chemical composition, physical performance analysis, testing instruments and equipment suppliers and service providers. Since its inception in 1995, has hundreds of business units, research institutes, laboratories and equipment to provide professional quality service



Wall Display Light Box
Hexagon Design

Wall Display Light Box Hexagon Design

free punching

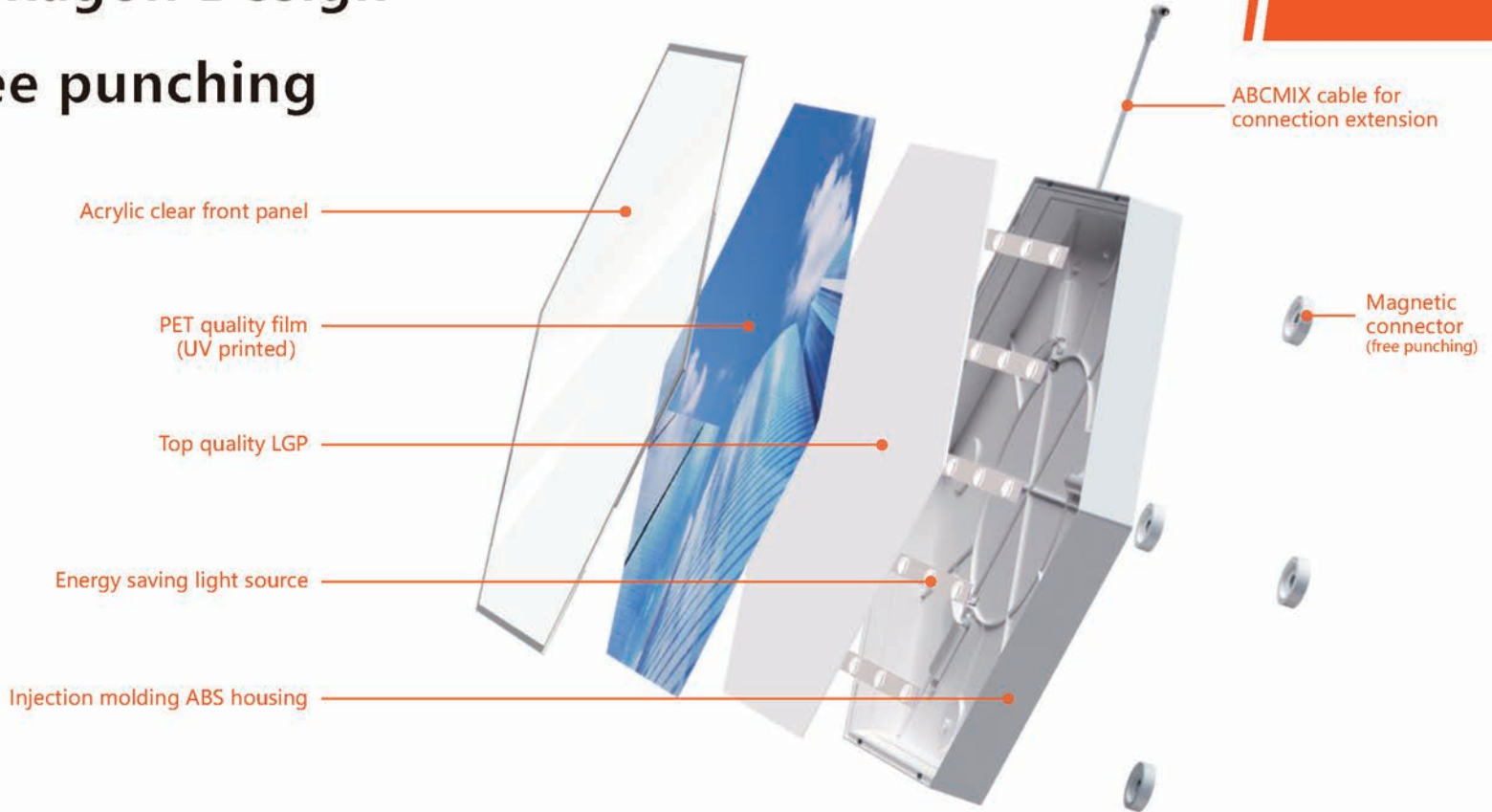

Installation instruction

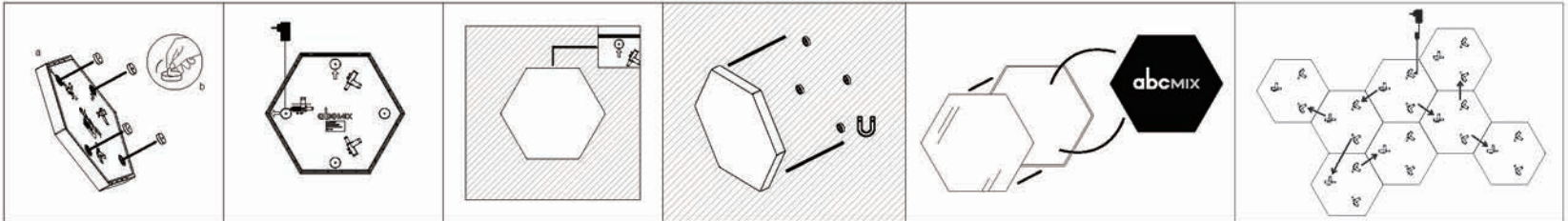

According to different application, this light box can be connected one by one. Recommended power supply, (5A) can drive 8 units maximum.

According to different application, this light box can be connected one by one.
Use designated power supply by ABCMIX, max. 8 units can work together.
More units need more power supplies.
Following is our designer's application recommendation.

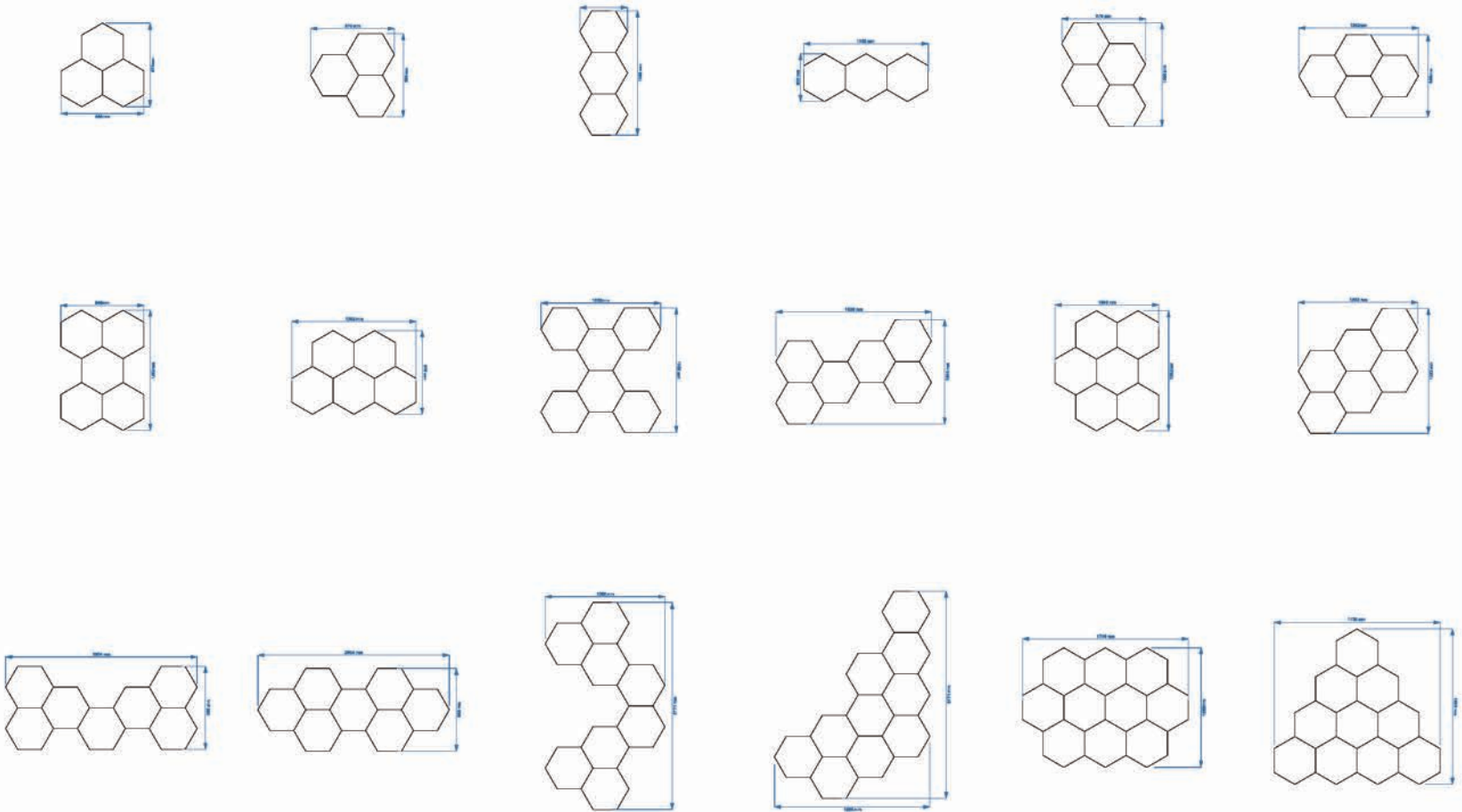



Company culture wall, exhibition hall, meeting room, museum, shop, flagship shop, background wall, etc.





Track Series Suspension Installation



This series is a track installation LED signage. It also with easiest installation design, with an option of suspending from ceiling, thus basically takes no extra spaces.

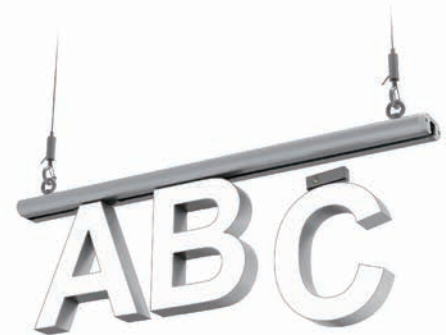

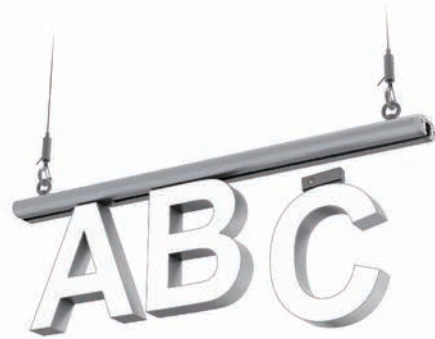



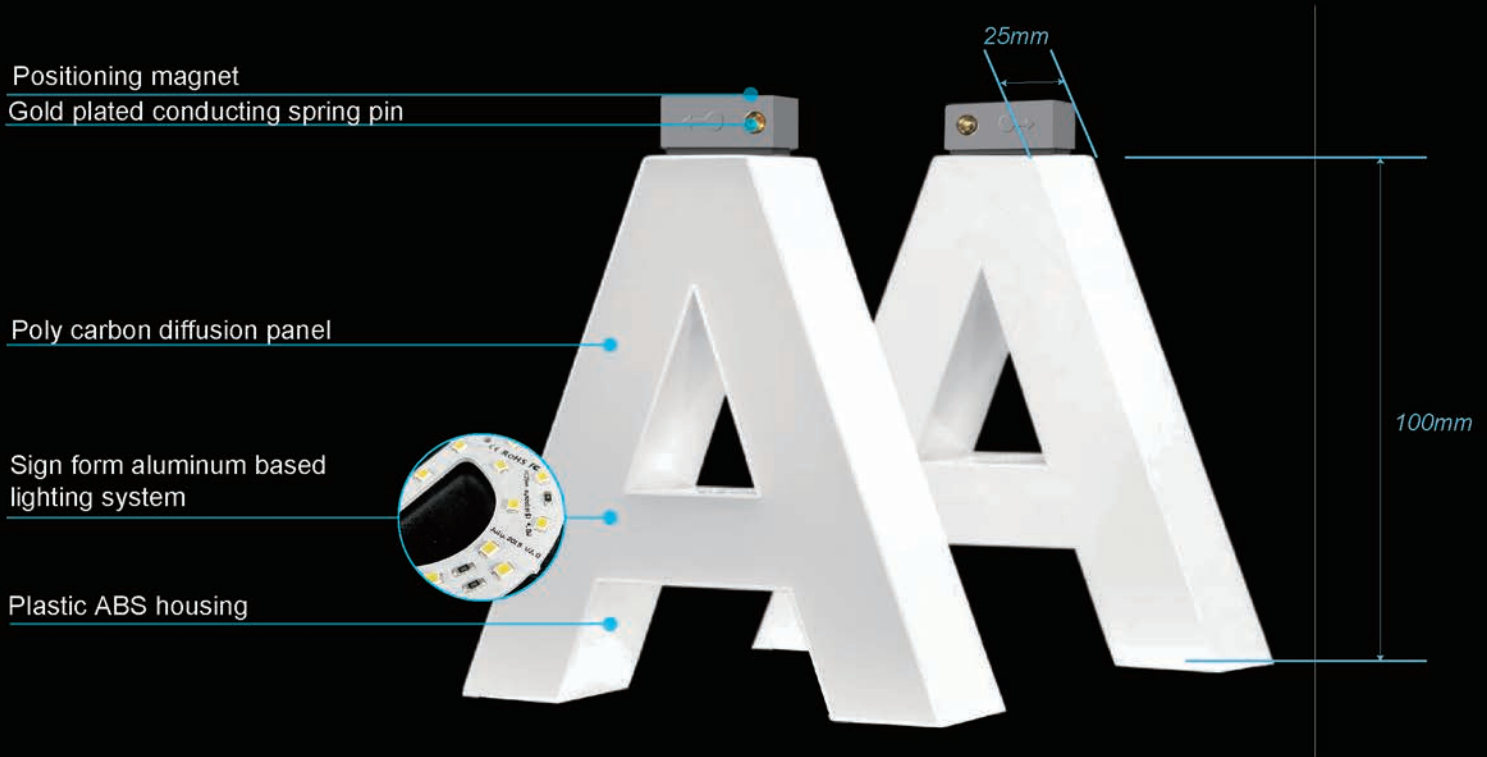

Suspension installation

You can suspend our track signs from the ceiling, which will take no space from your shop wall, counter or floor. You can also put them onto your reception desk or windowsill.

Like magnetic signs, materials of the track signs also including poly carbon diffusion panel, aluminum PCBA, plastic ABS housing, and positioning magnets etc. Different products and different batches also have the same brightness, same color temperature, same specification and same quality.



Recommended track and sign sizes

Recommended track size	Recommended sign size and maximum allowed quantities		
	H100 'A'	H150 'A'	H200 'A'
 L 600 mm 600*20*40 mm	6	4	3
 L 900 mm 900*20*40 mm	9	6	4
 L 1200 mm 1200*20*40 mm	12	8	6

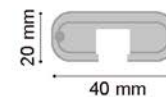

Scheme of the track profile

Recommended driver:
DC12V 3A 36W

Recommended sign sizes

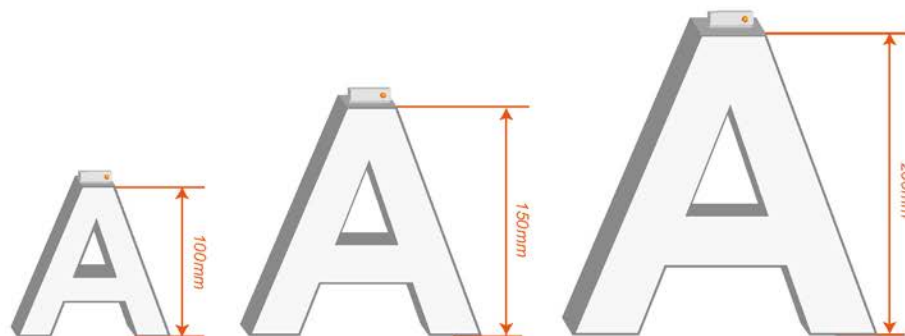

Manual



1. Drill screw holes from the ceiling



2. Install suspension cable

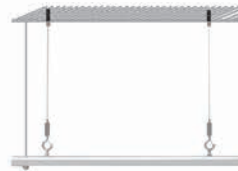

3. Hook up the track to the suspension cable and put the power cable in place.

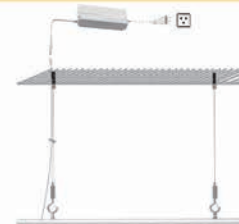

4. Connect to the driver.



5. Done.

Positioning magnets

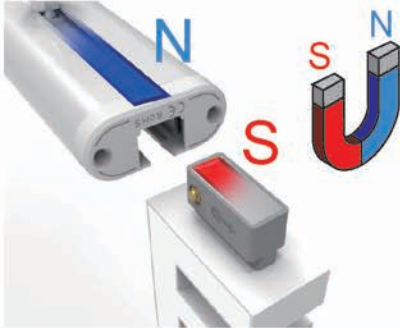

Each aluminum track equipped with a metal strip inside the track so to attract the magnets to the signs, this design will make the signs won't move in the track or fall out in windy environment.

Put the power cable in place

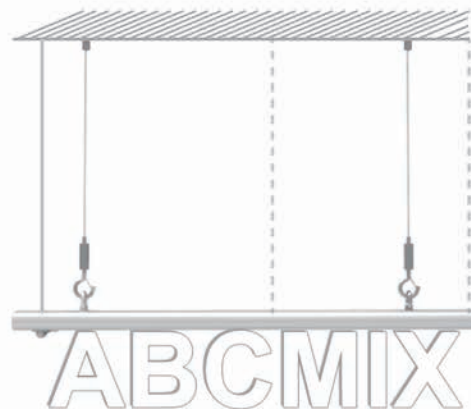

You can move the power cable to any position of the track.

Convenient design



Just slide the signs into the track, it will be lighted up automatically.



Aim the signs at the track, and then push it into place.

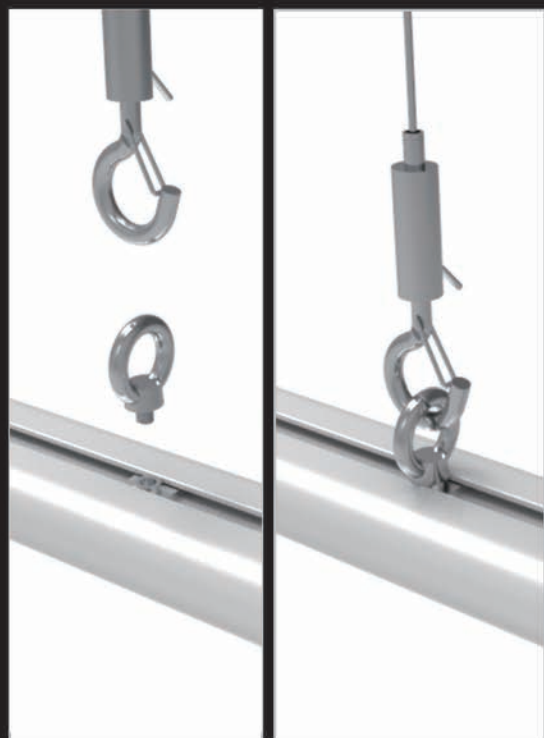

This is the connection system between the track and the suspension cable. You can change the length of the suspension cable easily.

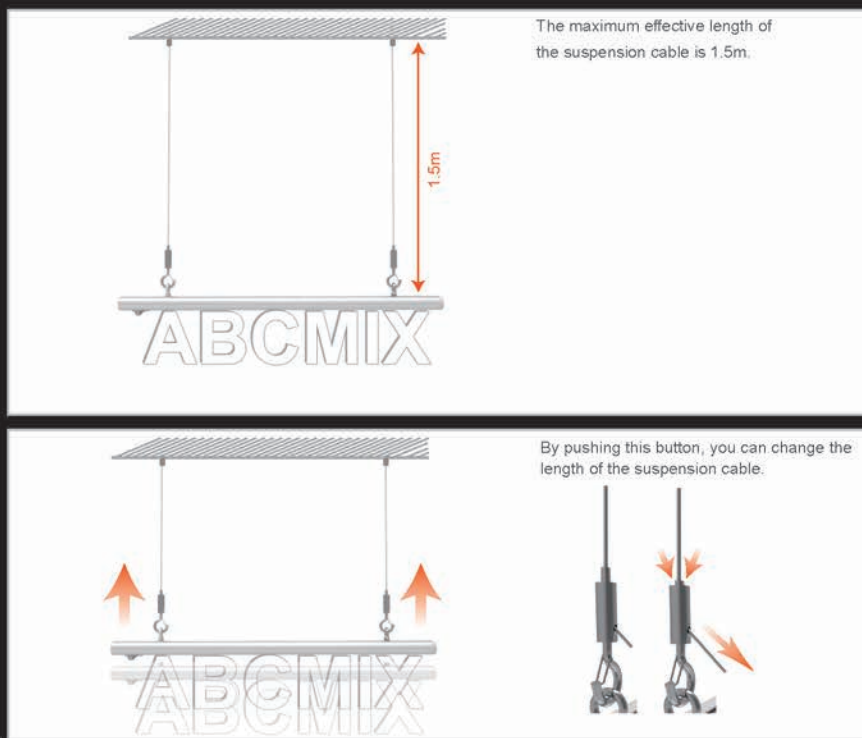



You can apply this series to many business occasions. Install the signs to the balcony, show window or counter ceiling will make your shop unique and attractive.

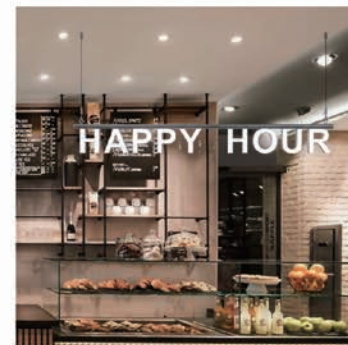



Imagine that you have a new item to promote, or discount offers, you can put your promotion words suspending from the ceiling of your show window, it will give the customer an urge to come in. It can also serve as direction signs in exhibition fair, airport, and bus station etc. to make these kinds of places friendly to everyone.



KIDSWEAR ↑





Top Track Round Lightbox



P3 letter display
Freestanding



P3 letter display

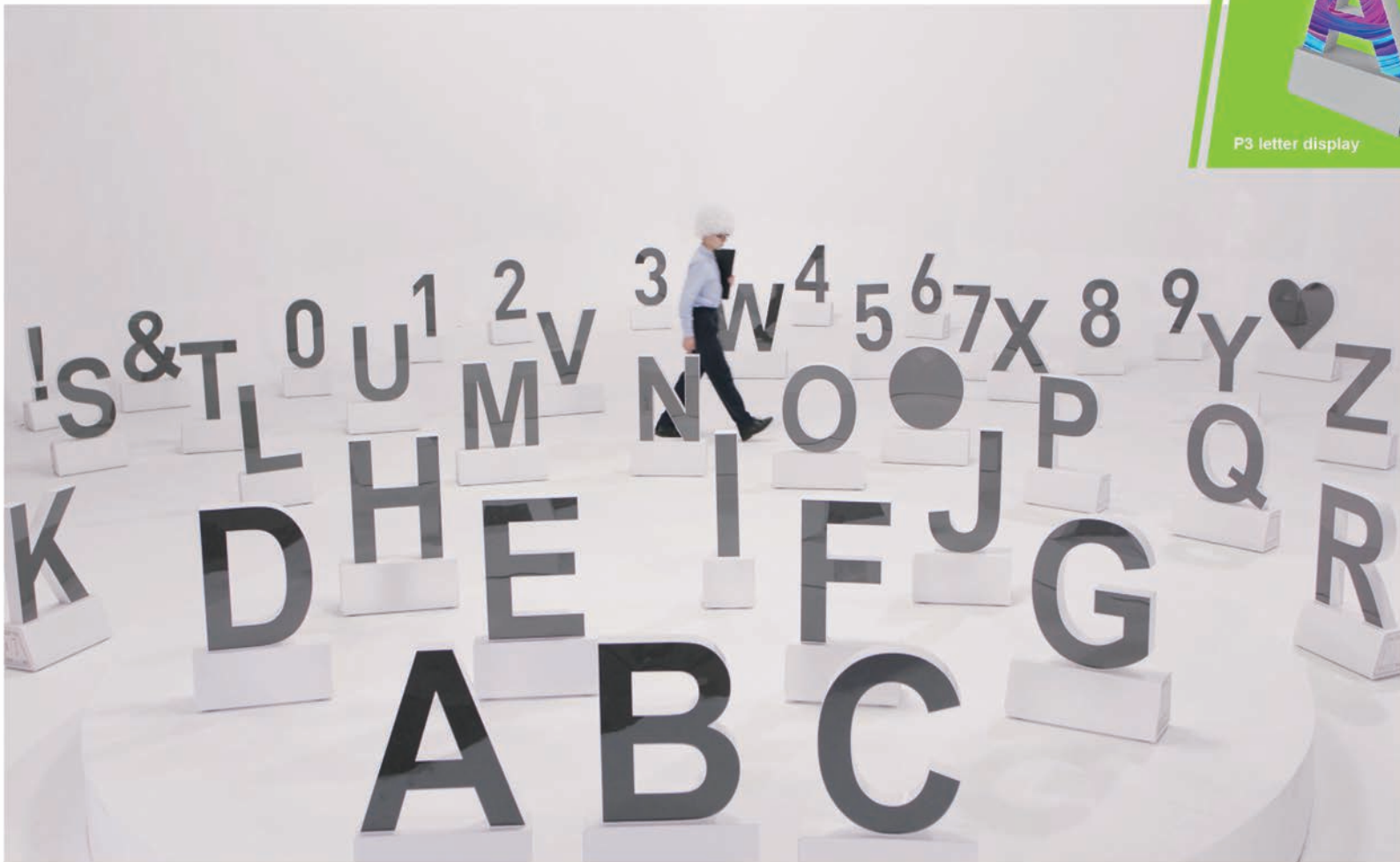

This series is our new product, and like our other products, also unique in the world. It consist of P3 letter displays, you can upload videos and audio suit for the scene style by a mobile app. Like our magnetic signs, you don't need any tools to complete the assembly. It usually applies to spacious event, like exhibition entrance, wedding ceremony and airport etc. It integrates audio, video and lights to achieve a mind blowing signage.





P3 letter display

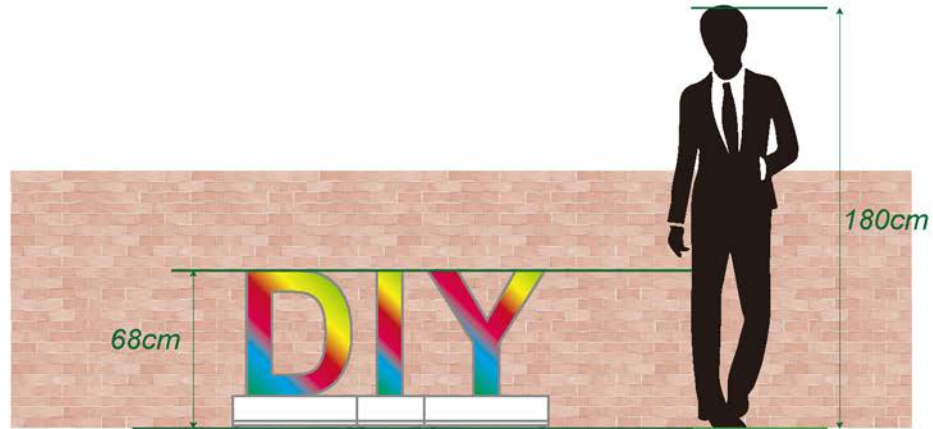

Magnetic connection

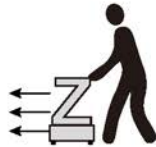

All direction trolley

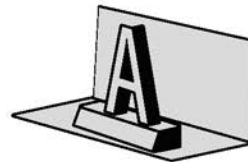

Free standing

The total height is 680mm, very easy to move around and group together. The products usually serve as freestanding, equipped with trolleys. Like our magnetic signs, at the ends of each base equipped with intensified magnets, which makes the installation quite easy and convenient.

We use magnet system, wireless signal system, high efficiency conducting system to our P3 letter displays. It's new and unique in the market. It integrates audio, video and lights to achieve a mind blowing signage.



P3 letter display

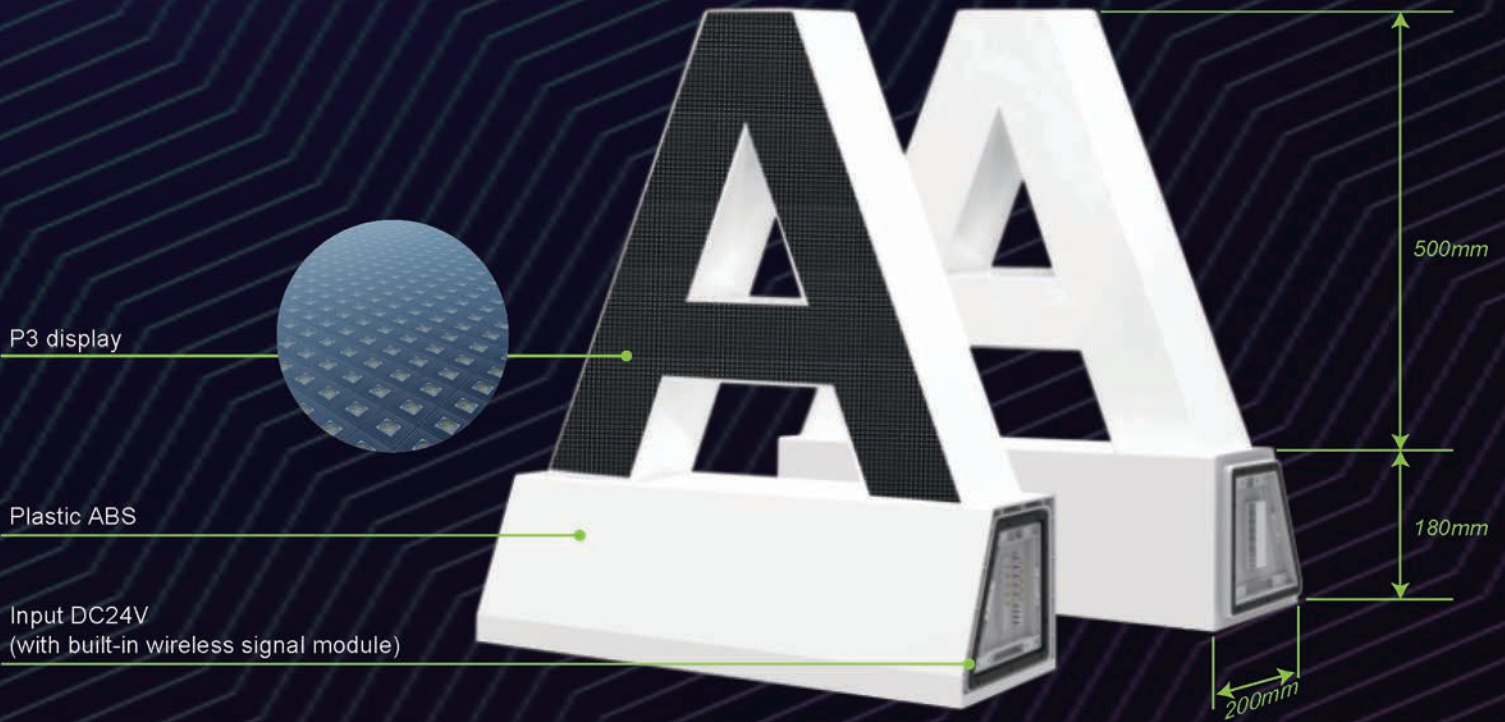



P3 letter display

Main features



All direction trolley system



Magnetic connection, easy installation design.



Complete items for choice, random combination.



Input DC24V, no concerns on safety.

Composition

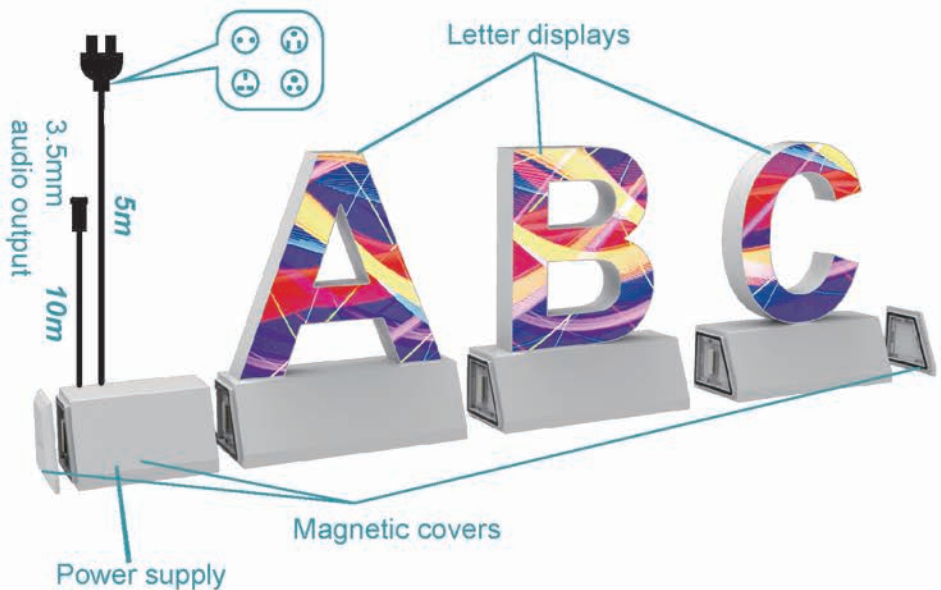

This is a series of products of considerateness, applies to many occasions, and with built-in audio and video system controlled by wireless signals. Like our other magnetic signs, come with easy installation design, you don't need any tools to complete the assembly.



P3 letter display

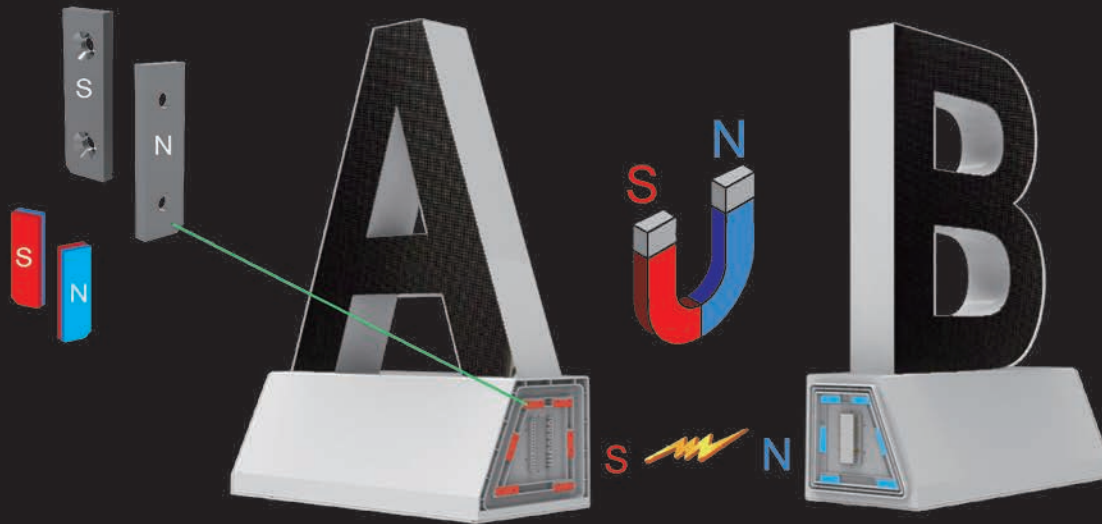

At each ends of the bases, installed with 6pcs intensified magnets. The bases will attract each other and connect together automatically when place them against each other. This kind design makes your installation and disassembly extremely efficient.



Push the letter displays against each other, the displays will connect automatically.



P3 letter display



For different scenarios, you can choose different sign group and videos & audios which suit for the occasions, and the signs can be easily moved around and changed. Our P3 displays can make events like exhibition, new products release and wedding ceremony etc. become more energetic and dynamic.



P3 letter display



If you want to make your party more energetic and dynamic, you can apply our P3 letter displays to your birthday, anniversary and wedding ceremony parties. Imagine all the nice videos and music playing vividly in these occasions, your party will become special and memorable.



P3 letter display



This is a real application example on the 10 years anniversary ceremony of SSIA in Shenzhen in 2020

In big events for example new product release, you can use our letter displays at these occasions. The press will make your events more influential.





You can also use our letter displays on forums and conferences, with vivid videos and music, the events will become special.

You can integrate your brand images into the letter displays to convey your company culture to visitors.





P3 letter display

1. Available items



2. Data sheet of the letter displays (IP20)

	Base width (mm)	Input voltage (V)	Input current (A)	Power (W)	Pixel (px)	NW (kg)	Package size (cm)		Base width (mm)	Input voltage (V)	Input current (A)	Power (W)	Pixel (px)	NW (kg)	Package size (cm)		Base width (mm)	Input voltage (V)	Input current (A)	Power (W)	Pixel (px)	NW (kg)	Package size (cm)
A	520	24	3.18	76.3	166	4.7	54.5*21*72.5	O	570	24	3.36	80.6	182	5.1	45.5*21*72.5	0	380	24	2.62	62.9	122	4	40.5*21*72.5
B	520	24	3.93	94.3	166	5.1	54.5*21*72.5	P	480	24	2.93	70.3	152	4.6	50.5*21*72.5	1	380	24	1.45	34.8	96	2.9	32.5*21*72.5
C	520	24	2.6	62.4	166	4.5	54.5*21*72.5	Q	570	24	3.56	85.4	182	5.2	59.5*21*72.5	2	380	24	2.23	53.5	122	3.8	40.5*21*72.5
D	520	24	3.34	80.2	166	5	54.5*21*72.5	R	520	24	3.55	85.2	166	5.2	54.5*21*72.5	3	380	24	2.2	52.8	122	3.7	40.5*21*72.5
E	480	24	3.24	77.8	152	4.8	50.5*21*72.5	S	480	24	2.99	71.8	152	4.5	50.5*21*72.5	4	380	24	2.31	55.4	122	3.9	40.5*21*72.5
F	430	24	2.43	58.3	136	4	45.5*21*72.5	T	430	24	2.06	49.4	136	3.8	45.5*21*72.5	5	380	24	2.43	58.3	122	3.8	40.5*21*72.5
G	570	24	3.18	76.3	182	5.1	59.5*21*72.5	U	520	24	3	72	166	4.6	54.5*21*72.5	6	380	24	2.2	52.8	122	3.8	40.5*21*72.5
H	520	24	3.18	76.3	166	5	54.5*21*72.5	V	520	24	2.57	61.7	166	4.5	54.5*21*72.5	7	380	24	1.72	41.3	122	3.5	40.5*21*72.5
I	220	24	1.39	33.4	70	2.7	24.5*21*72.5	W	665	24	4.77	114.5	212	6.3	68.5*21*72.5	8	380	24	2.75	66	122	4.1	40.5*21*72.5
J	430	24	1.9	45.6	136	3.6	45.5*21*72.5	X	480	24	2.93	70.3	152	4.6	50.5*21*72.5	9	380	24	2.21	53	122	3.8	40.5*21*72.5
K	520	24	3.3	79.2	166	4.9	54.5*21*72.5	Y	480	24	2.19	52.6	152	4.1	50.5*21*72.5	&	520	24	3.3	79.2	166	5	54.5*21*72.5
L	430	24	1.95	46.8	136	3.7	45.5*21*72.5	Z	480	24	2.91	69.8	152	4.7	50.5*21*72.5	!	220	24	1.13	27.1	70	2.9	24.5*21*72.5
M	570	24	4.34	104.2	182	6.1	59.5*21*72.5	♥	665	24	5.71	137	212	6	68.5*21*72.5	Spacer	220	24				1.5	24.5*21*72.5
N	480	24	3.65	87.6	152	5.1	50.5*21*72.5	•	570	24	5.71	137	182	5.8	59.5*21*72.5	Circle unit	220	24				6	24.5*21*72.5

Products data sheet



P3 letter display

Data sheet of the controller unit					
600W	Input:100-120V	The actual 600W	Output:24V~:25A	Maximum allowed letter displays are 7 pcs	Maximum allowed pixels are 1,920px
	Input:200-240V	The actual 600W	Output:24V~:25A		
1000W	Input:100-120V	The actual 816W	Output:24V~:34A	Maximum allowed letter displays are 11 pcs	Maximum allowed pixels are 3,840px
	Input:200-240V	The actual 1000W	Output:24V~:42A	Maximum allowed letter displays are 13 pcs	

3.How to calculate the power consumption

*Make sure the total power consumption (W) and total pixels (PX) of the grouped letter displays won't overload the power supply.

For example:

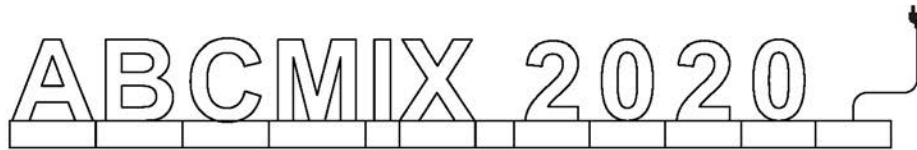

$$\begin{aligned}
 \text{Total power consumption:} & \quad 76.3 + 94.3 + 62.4 + 104.2 + 33.4 + 70.3 + 53.5 + 62.9 + 53.5 + 62.9 = 673.7 \text{ W} \\
 \text{Total pixels:} & \quad 166 + 166 + 166 + 182 + 70 + 152 + 122 + 122 + 122 + 122 = 2435 \text{ px} \\
 \text{Total length:} & \quad 520 + 520 + 520 + 570 + 220 + 480 + 220 + 380 + 380 + 380 + 380 + 220 = 4790 \text{ mm}
 \end{aligned}$$

From above table we can get that the total power consumption of letter display "ABC MIX2020" is 973.7W, total pixel is 2,435px, so this group need a 1,000W controller unit.

For rental market, 1,000W controller unit is always recommended.



If you plan to upload a video to the letter displays, it's recommended that the resolution is bigger than 160px, the file format is MP4, and file size is less than 500MB.



**Double Sided LED Sign Board Display
IP65 Horizontal**



Double-sided sign board display

This product is made by P3.0 HQ and HB display. It's with IP65 outdoor design, and like our other products, original and unique in the market too. It's really a mind-blowing eye catcher should you got one for your shop.



IP65

Double Sided LED Sign Board Display Horizontal installation



Double-sided sign board display

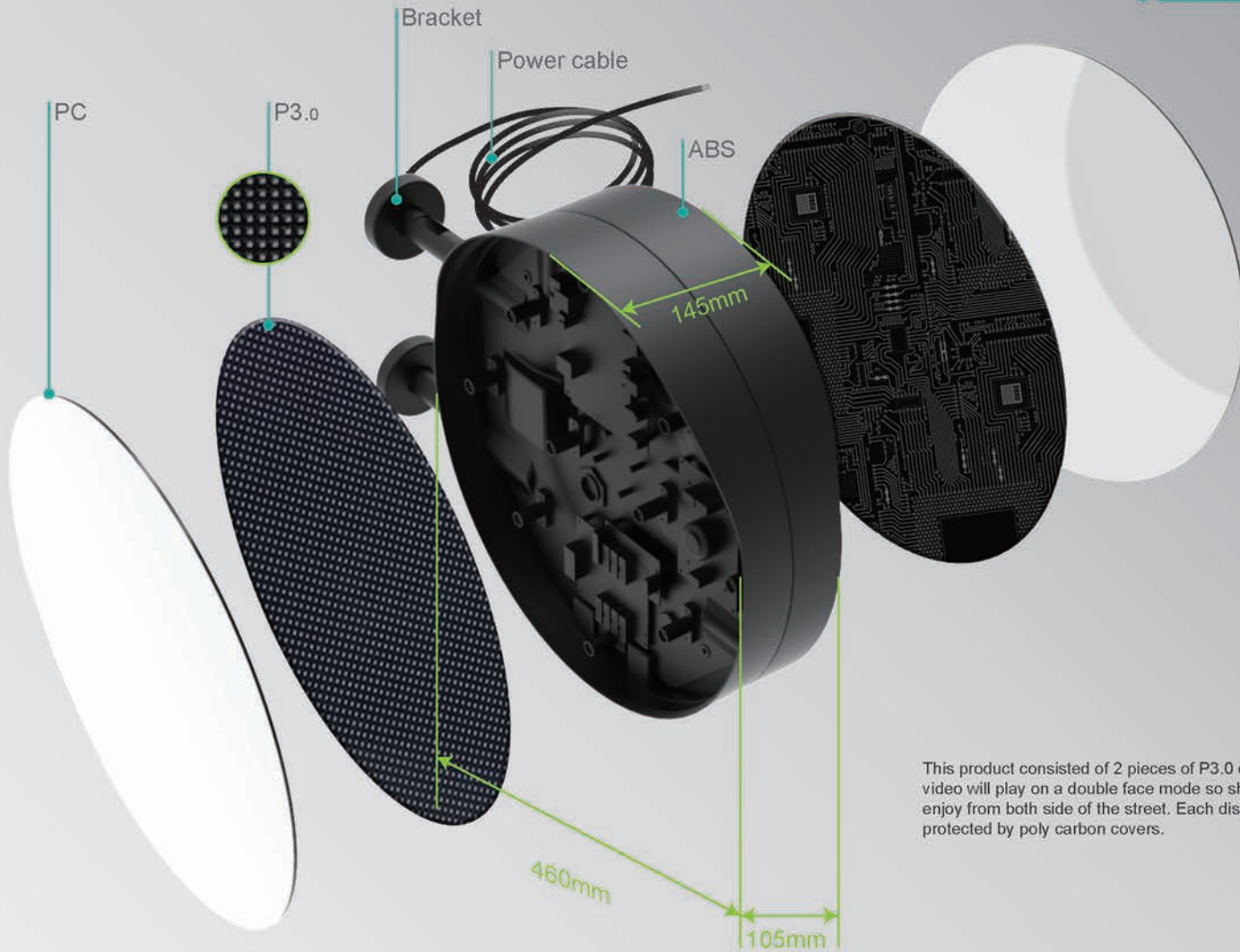

This product consisted of 2 pieces of P3.0 displays, the video will play on a double face mode so shoppers can enjoy from both side of the street. Each display is protected by poly carbon covers.

Double Sided LED Sign Board Display
Horizontal installation



Double-sided sign board display

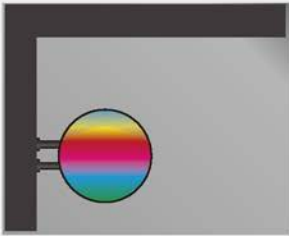
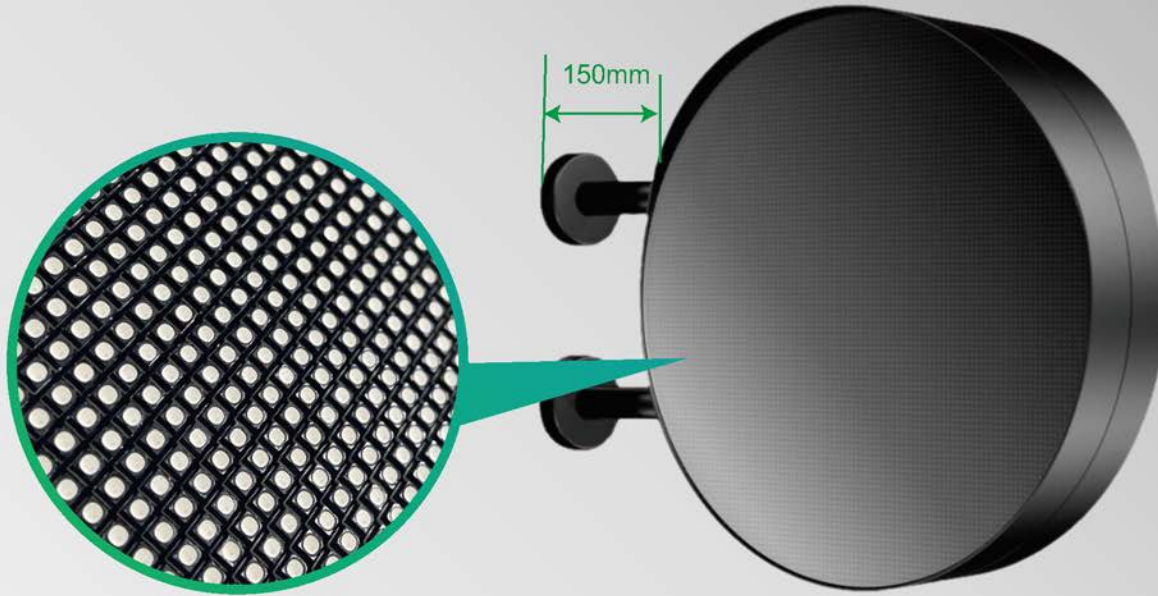

Horizontal

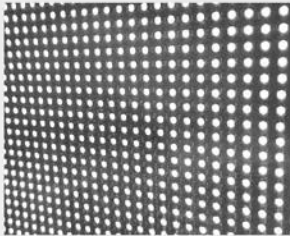

Maximum white balance
brightness > 5000cd/m²

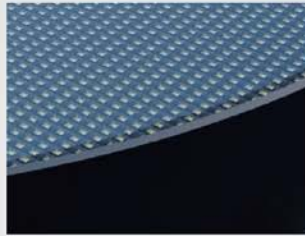

Edgeless, full screen display



IP65 outdoor design



Double curved face design



Double-sided sign board display

Imagine in a busy street, the sign board will make your shop and your advertisement an eye catcher.





Usually, the traditional shops only have front sign boards, so they have no good way to attract shoppers from both side of the street away from their shops, especially when they only have a blister sign board. If they use our double-sided storefront signboard display, it will attract shoppers half kilometers away, and make the shop become a star in the street.



Double-sided sign board display



Double-sided sign board display





Double-sided sign board display



Under development

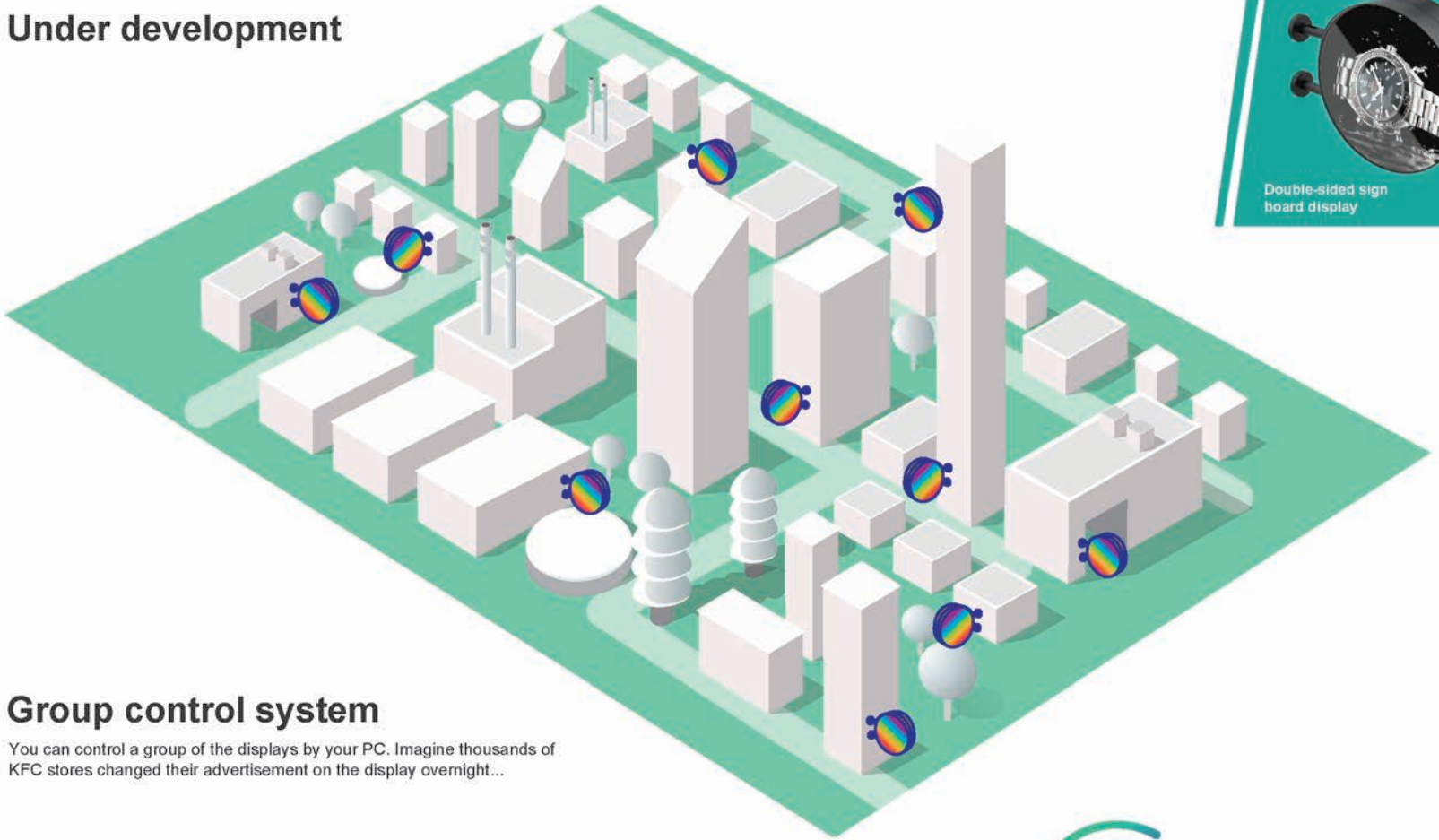

Double-sided sign board display

Group control system

You can control a group of the displays by your PC. Imagine thousands of KFC stores changed their advertisement on the display overnight...

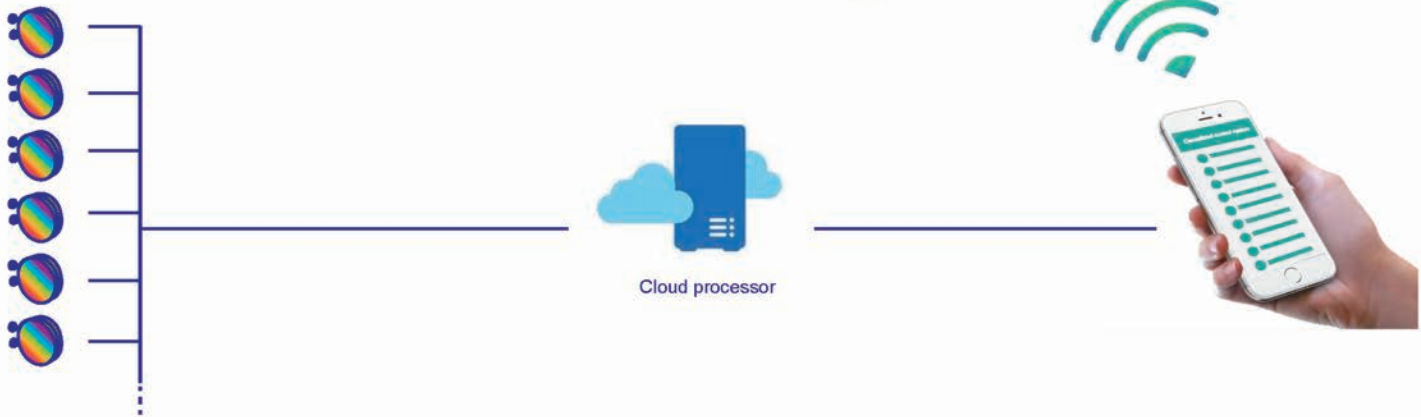



Double-sided sign board display



For example, a watch shop installed a sign board display, and then shoppers from both sides can watch your advertisement simultaneously.



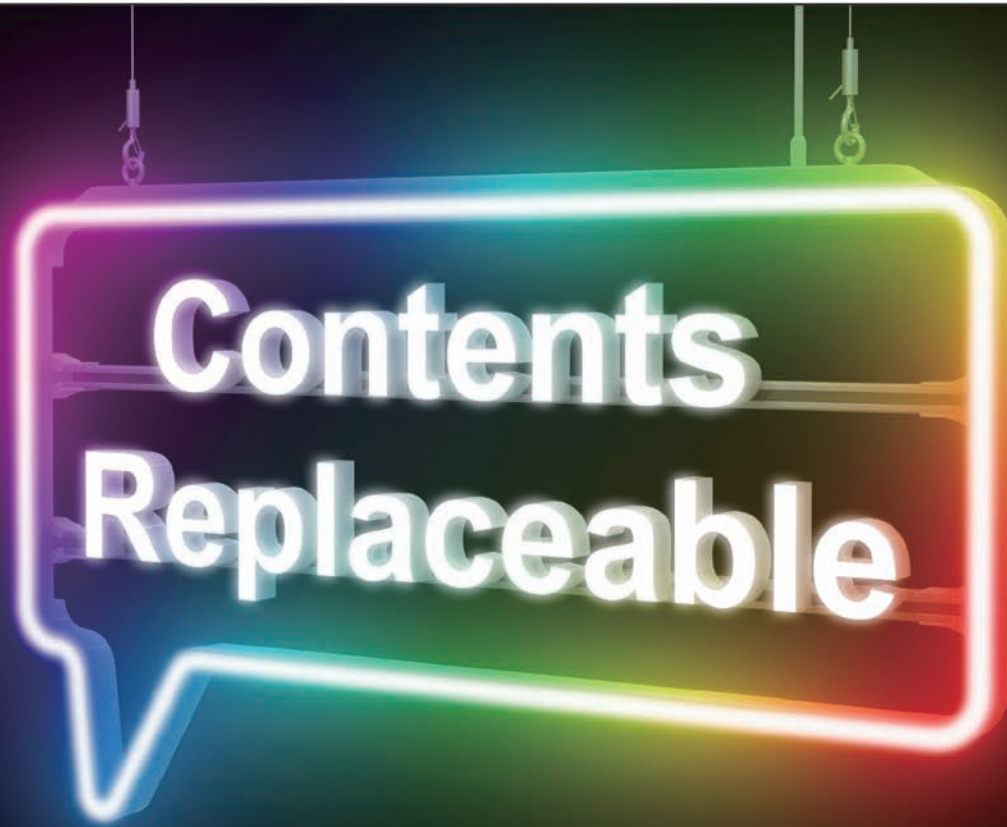

LED advertising board
Suspension installation

Contents
Replaceable

LED advertising board

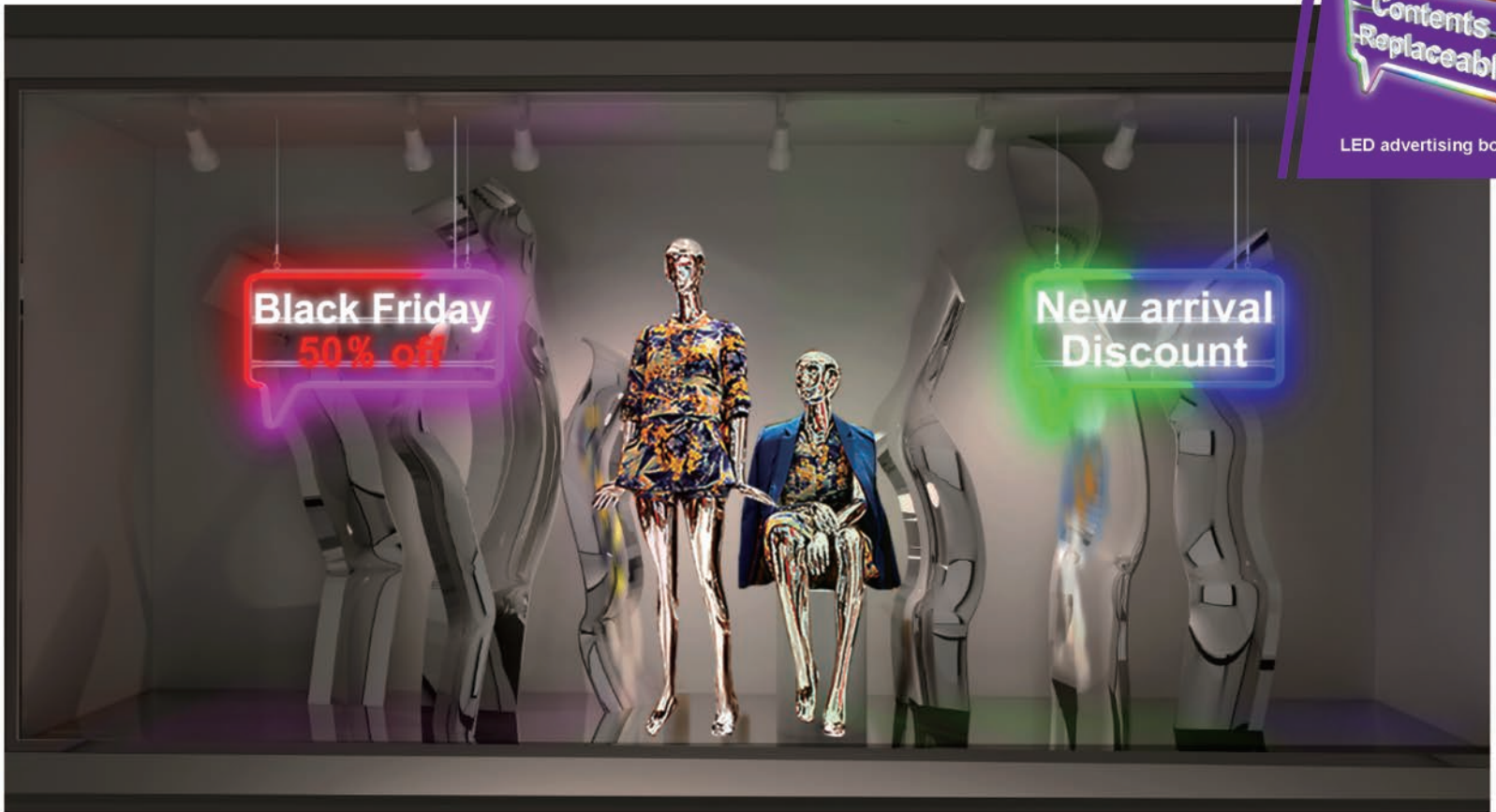

This is a very cool LED sign board with convenient installation design. You can install it onto the ceiling of your reception desk, or your shop show window etc. It won't take any of your precious shop wall or ground space. More than a hundred LED patterns and 500 colors in the frame you can choose from. Its colorful patterns and dancing lights will make your shop unique and outstanding from others.

Contents
Replaceable

LED advertising board

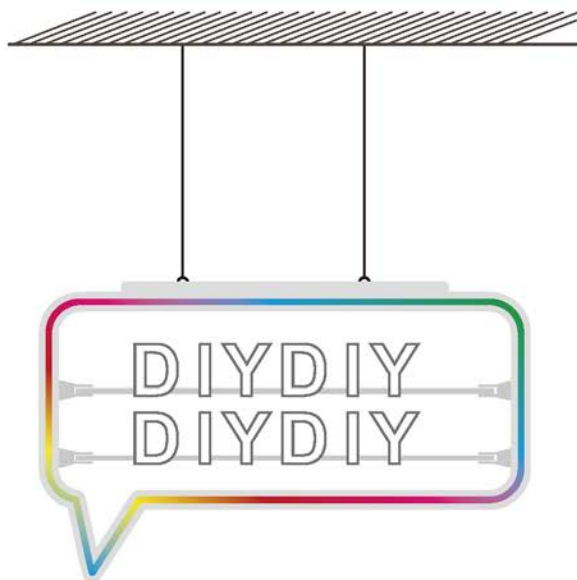

**Download the app to your cellphone
Choose a LED pattern you like**

The frame is with a built-in 7 color LED strip, total more than 120 patterns you can choose from: gradually change, dancing, blinking, chasing, etc. With the cool and colorful frame combined with our track LED letters, this will make your promotion very eye catching. It's also a nice decoration to your show window.

Contents
Replaceable

LED advertising board

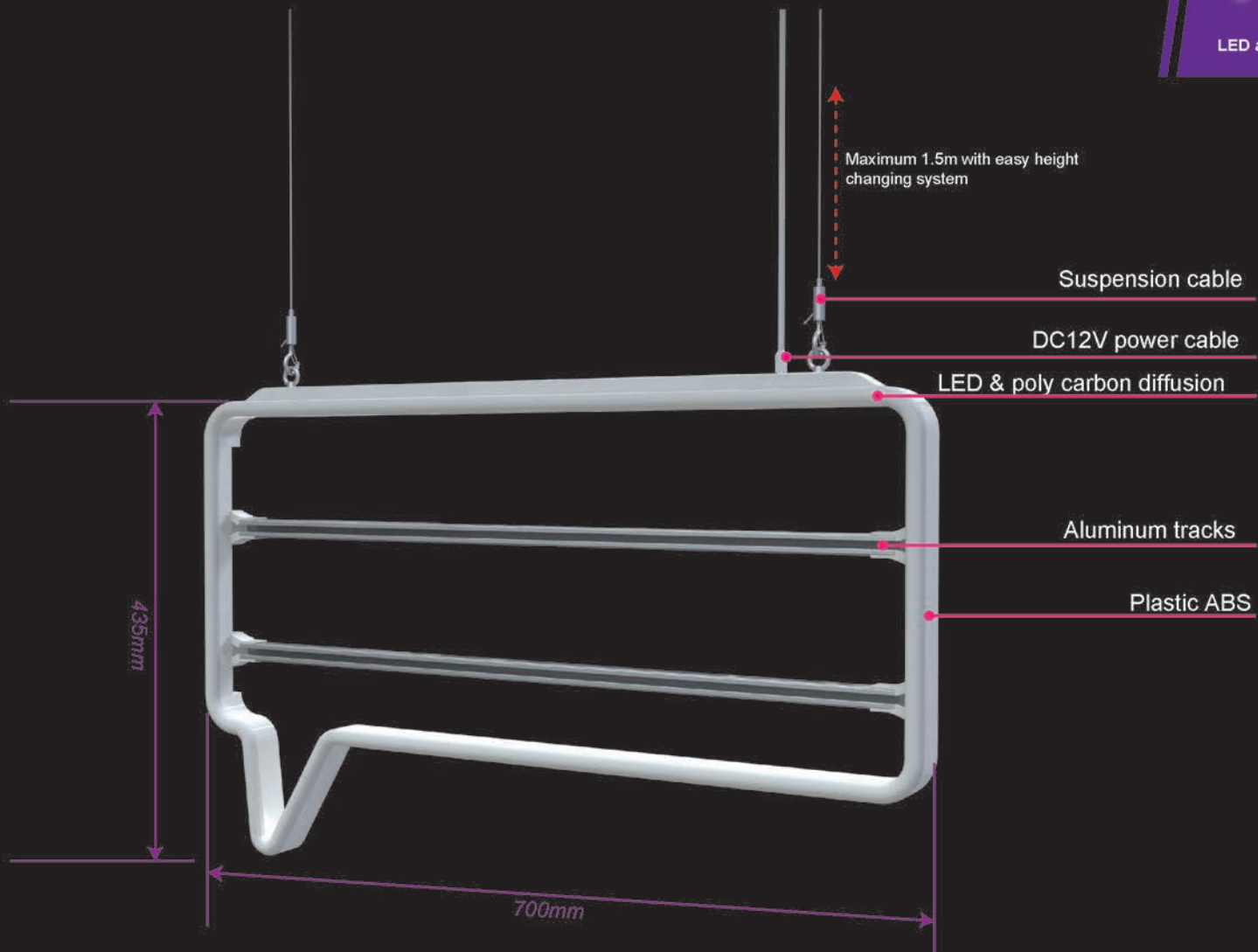

Accessories and recommended signs

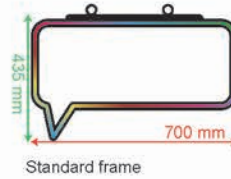

≤8pcs H75mm capital letters
are recommended



≤12pcs H75mm lower case
letters are recommended

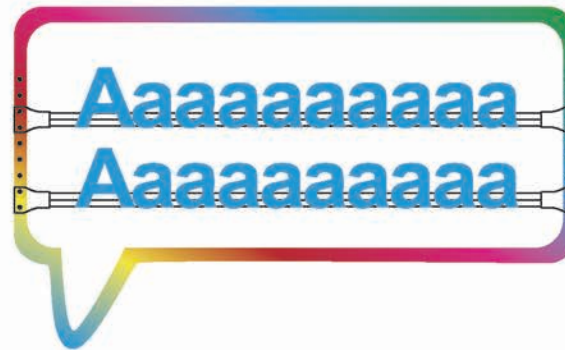

This product can combine with our H75mm back track LED signs both capital and lowercase to spell two lines of promotion words.



LED advertising board

Installation



1. Slide the letters into place.



2. Click the tracks into place from the back of the frame.



3. Connect to the DC driver to put on the lights.



4. Download the mobile app, choose your favorite LED patterns by blue tooth

You can just take out the tracks and change the letters, then simply click the tracks back from the back of the frame. After connect to the DC driver, both frame and letters will light up automatically. Through the mobile app, you can choose your favorite LED patterns by blue tooth.

Contents
Replaceable

LED advertising board



Contents
Replaceable

LED advertising board



This product is with easy installation design, and all the letters can be easily replaced. You can use this product in supermarket, or shop show window to make a promotion, and it can also serve as a nice decoration.



**Wall signs
IP65/wall installation**



Wall signs



IP65

Different from traditional sign makers, our wall signs use plastic ABS housing and sign shaped LED lighting system to achieve standard, uniform and stable quality products. Like our other signs, our wall signs also have a lot of available sizes, and they are also ready-made, no need to customizing. You order, we deliver, no production lead time.



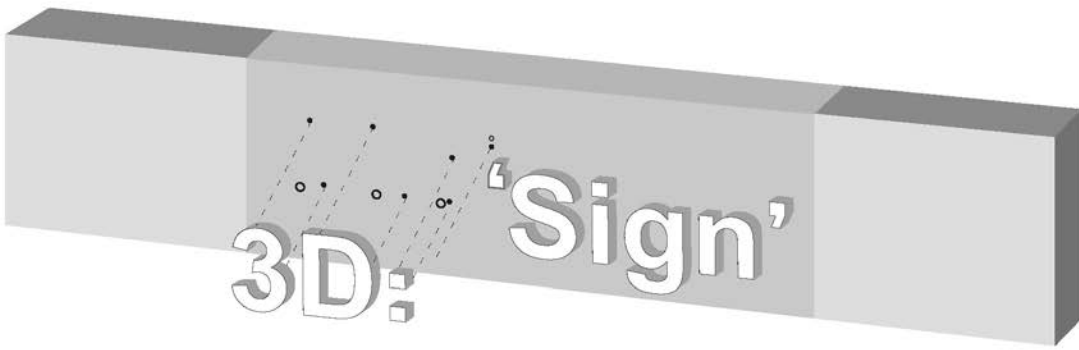

Standardized products, high quality LED signs, they will help your shop maintain beautiful lighting and also good brand image.



Wall signs



The wall signs consist of polycarbonate diffusion panel, sign shaped aluminum PCB and LED system, and plastic ABS etc. Different products and different batches have the same brightness, same color temperature, same specification and same quality.

Polycarbonate diffusion panel

Sign shape aluminum PCB and lighting system

Plastic ABS housing

Power cable



Products features

This series including accessories are also original design, and passed our reliability and aging test.



IP65 OUTDOOR DESIGN

Outdoor design, IP65 waterproof grade.

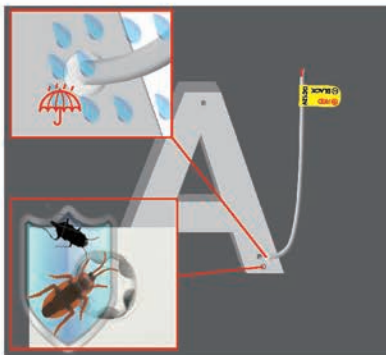

ANTI-BUGS DESIGN / NO LEAKING LIGHT

S shape dripping holes design makes sure no bugs can get in but water still can dripping out.



Sign shaped aluminum PCB and LED system

Lights are evenly distributed, and aluminum PCB makes sure more efficient heat radiation.



Polycarbonate diffusion panel

Polycarbonate diffusion panel is stronger than acrylic, and has better performance in high temperature and UV.



Injected plastic housing

The plastic housing is made by automatic injection machine.

Laminated lighting system

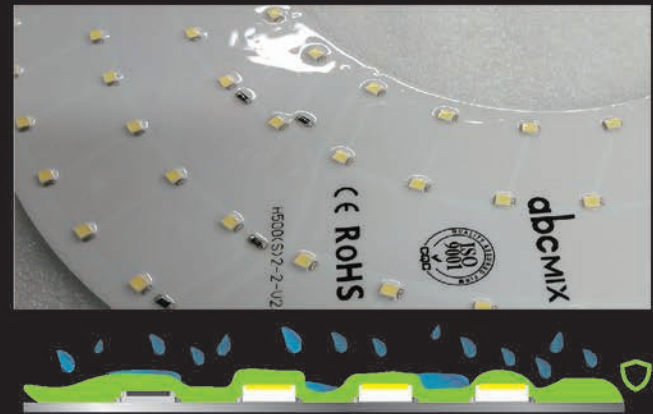

Features of the back

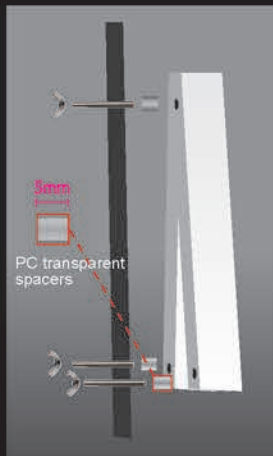

A B C X Y Z

Screws of different signs always keep at the same level.

The PC spacers make sure there is no stagnant water on the housings, this will prevent the housing grow moss over time, and the spacers also can strengthen the 3D effect of the signs.

The screws in the back are designed to be always at the same level.

Accessories and installation

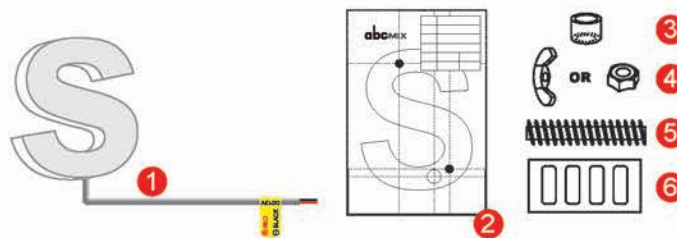

Accessories:

- 1 Signs
- 2 Mounting template
- 3 Spacers
- 4 Nut
- 5 Screw rod
- 6 Adhesive

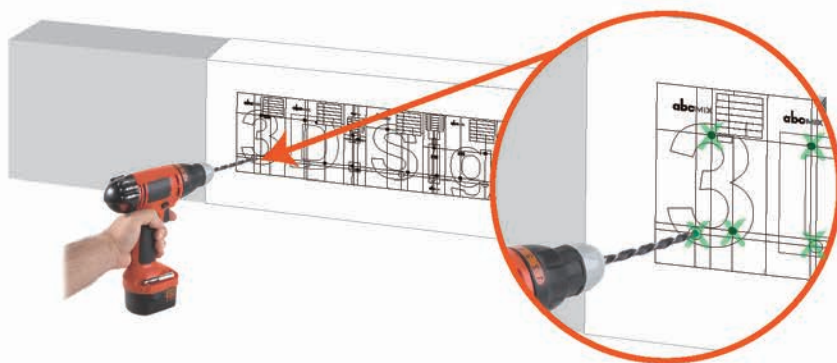

Manual

1. Use the adhesive to stick the templates to the place where you intend to install the signs, and drill holes according to the templates.

2. Install the screws and spacers at the back of the signs, then put the cables and screws through the holes, and use the nuts to fix the signs in place.

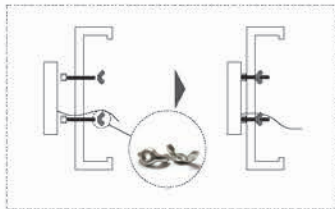

3. Connect the cables to a driver and light up the signs.

⚠ The input of the signs is DC12V, never use input voltage higher than that, or it will burn the LED chip, or even electrocute the worker.

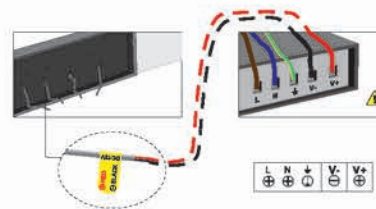

Recommended sizes

Recommended sizes of wall series are H100mm, H150mm, H200mm and H500mm.

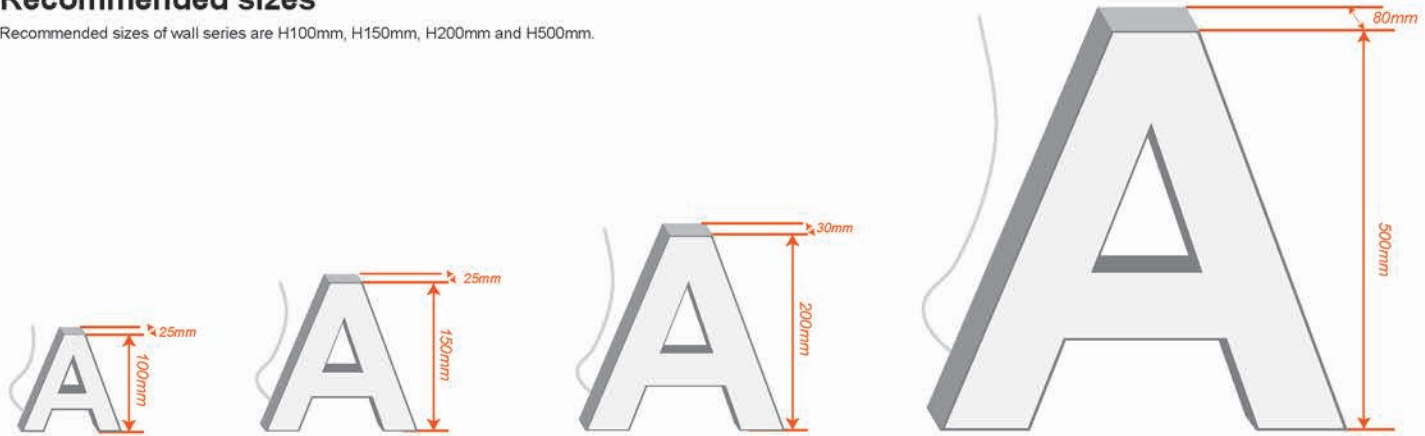

130

Circuit diagram design (a net of series and parallel connection)

One LED broken won't fail the other LEDs.

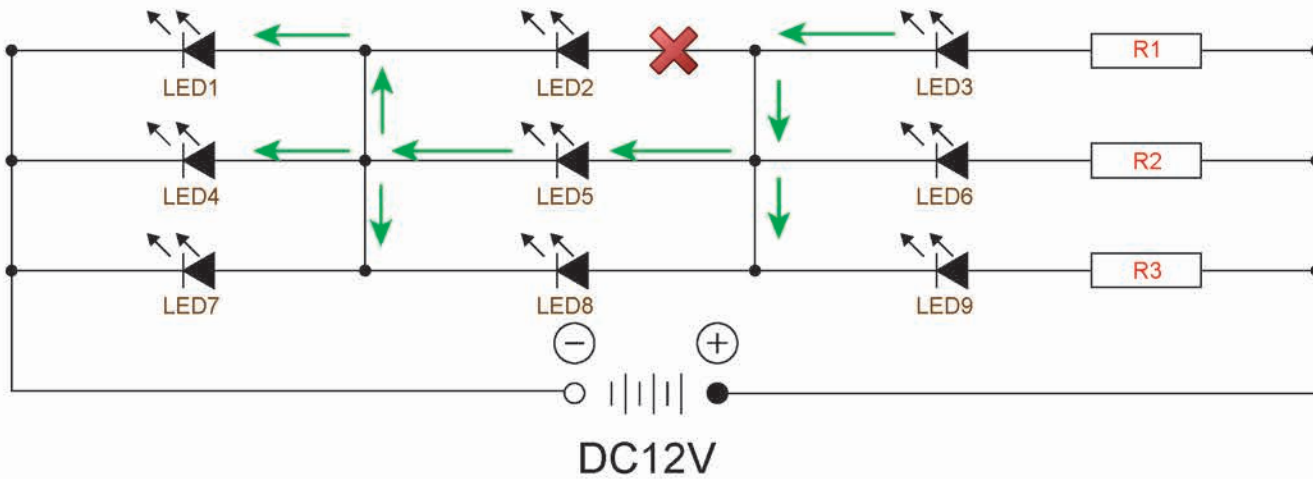



Wall signs



This is a real application case. You can use it to light up your shop sign board. By using our individual wall signs, you can spell any words you like.

 **Russia**



These are other application cases. You can use them on different occasions as direction or instruction signs. For example, above the shelves of supermarkets, on your shop sign boards, etc.



Wall signs

MUSIC BAR





Wall signs

PIXEL LETTER SCREEN



Top track open sign





Lucky cat counter display





60s voice recording, smart radar sensor(3-5m), adjustable volume(3 levels)

Ready-made products











- Standardized production
- 20,000 square meters warehouse
- Distributors and resellers all over 100+ countries

—**ABCMIX OF THE WORLD,
ABCMIX OF YOURS**

Recommended items (2021 version)

SN	Sign height (mm)	Font							
			IP20	IP20	IP65	IP20	IP65	IP20	IP65
1	H100	Arial	★	★	★				
2	H150	Arial	★	★	★		★		
3	H200	Arial	●	★	★				
4	H500	Arial			●				
5	H680	Arial	★			★			
6	H95 3D	Arial	●						★
7	H125	Gulim	●						

★ Best seller
 ★ Highly recommended
 ● Custom only

Pictures, features, material, and data listed in this catalogue are for reference only. Please contact local distributors for more information.

For certificates or conformity of regulations, please also contact local distributors.





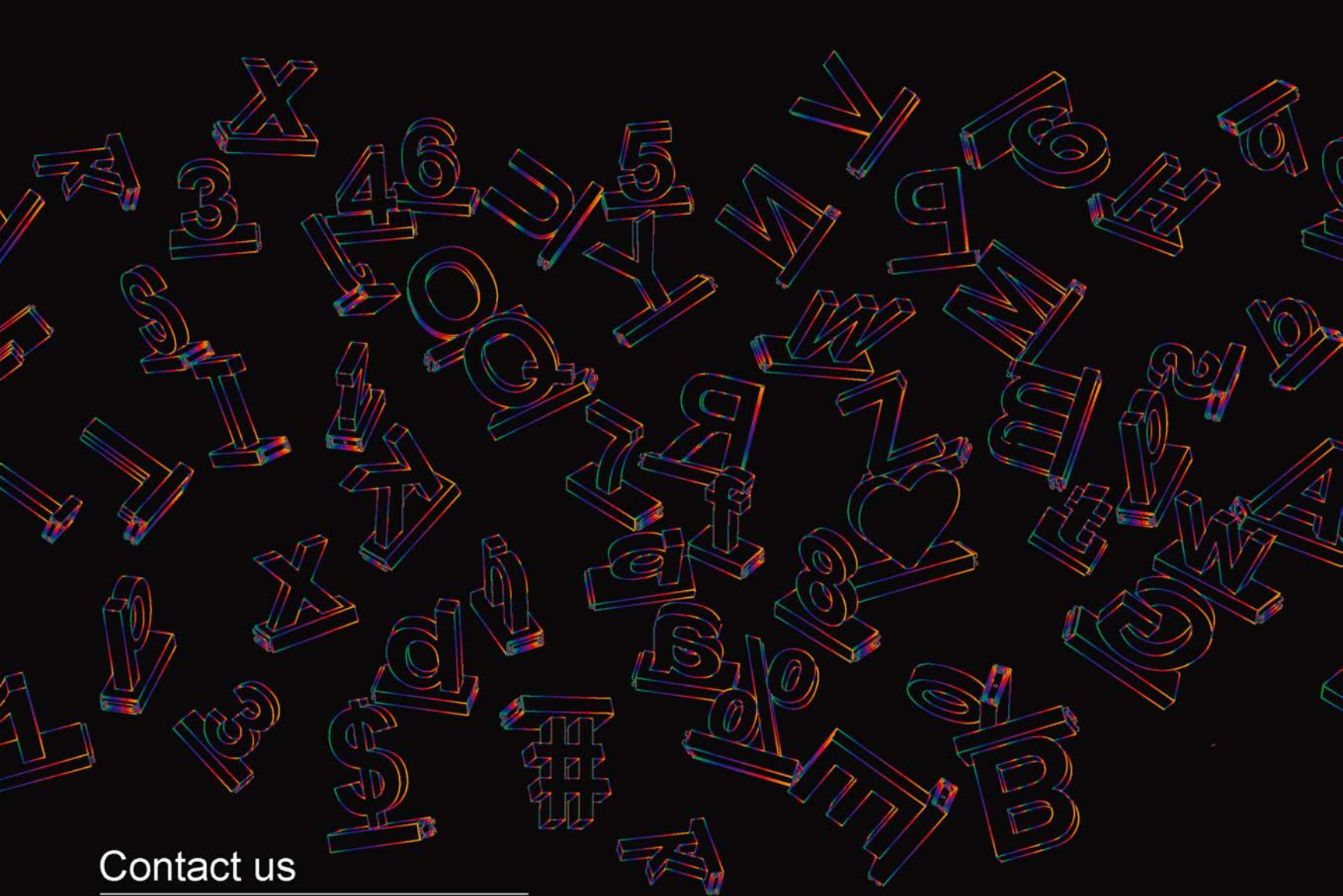

abcMIX
REDEFINE SIGNAGE





Contact us

ABCMIX CO.,LTD.

 (86)400-000-3268

 (86)755-29885819

 info@abcmix.com

 www.abcmix.com

 **Headquarter** : Bldg 5, Jia Zi Tang Community, Feng Huang Street, Guang Ming District, Shenzhen, PRC.

Manufacturing base : Ke Chuang Industrial park, Economy Development District, Qi Yang County, Hunan Province, PRC.

