

INDOOR



F A R O
BARCELONA



Edition
A2026IN

Art direction and design
Faro Art

All Rights Reserved
Reproduction without written permission from
the publisher is strictly prohibited.

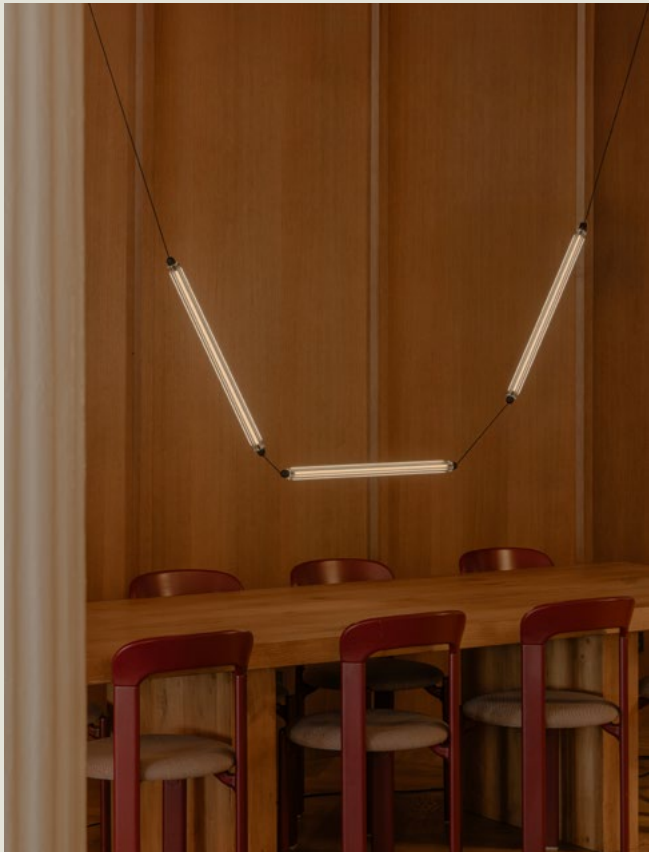

Indoor Collection

Portable	32
Table & Floor	40
Clip-on	160
Suspended	168
Ceiling	288
Wall	330
Recessed	548
Track	598
Bulbs	606
Shades	615



Portables



Buddy
34



Fuji
36



Take Away
38

Table



Cata
42



Shan
44

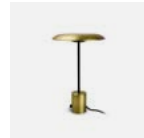

Hoshi
46



Moy
48



Amelia
48



Niko
50

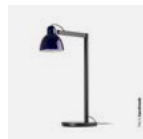

Venice
86

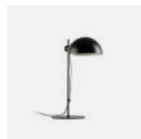

Dominica
88



Martinica
90

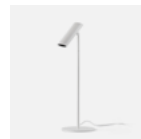

Leo
92



Studio
96



Guadalupe
98

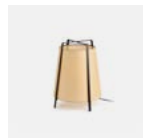

Akane
118



Windsor
120



Drum
122



Samba
124



Conga
126



Montreal
128



Berni
146



Volta
148



Inviting
150



Academy
150



Anouk
152

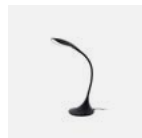

Otto
154

Floor



Staff
58

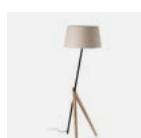

Treewood
60



Stand Up
62

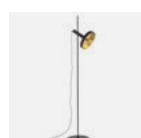

Whizz
62



Guest
64



Jellyfish
64



Leo
92

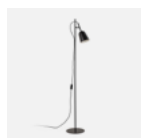

Studio
96



Guadalupe
98



Liggera
100



Link
102



Lao
104



Samba
124



Conga
126



Montreal
128



Savoy
130



Rem
132



Artis
134



Ten
52

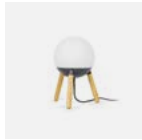

Mine
52



Sumba
54



Moma
54



Lula
56

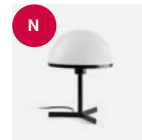

Dome
70

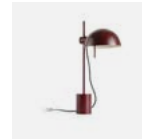

Matilda
76



Tatawin
80

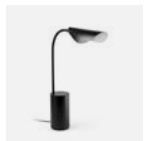

Liggera
100

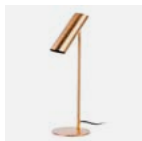

Link
102



Lao
104

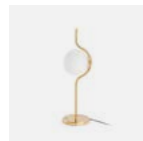

Le Vita
106



Luang
108

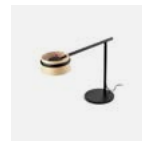

Loop
112



Stood
114



Mambo
116



Savoy
130



Rem
132



Artis
134



Nila
136



Vesper
138



Linda
140



Lupe
142



Tree
144



Lena
154



Ito
156



Baobab
156

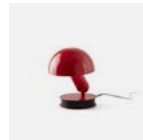

Bela
162



Black
66



Papua
66



Dome
72



Matilda
76



Tatawin
82



Venice
86

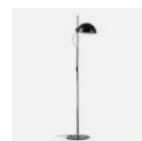

Dominica
88



Martinica
90

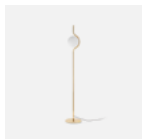

Le Vita
106



Luang
110

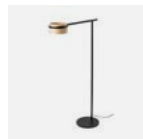

Loop
112



Stood
114



Mambo
116

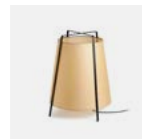

Akane
118



Windsor
120



Drum
122



Nila
136



Vesper
138



Linda
140

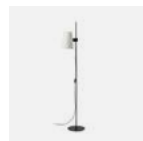

Lupe
142



Tree
144



Berni
146



Volta
148

Clip-on

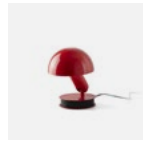

Bela
162



Inviting
164

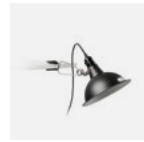

Pepper
166

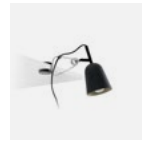

Studio
166



Lena
166

Suspended

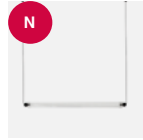

Lumina
178



Tierra
182

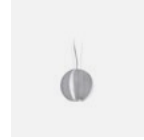

Aire
186



Cata
188

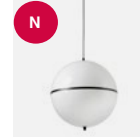

Dome
191



Dome
191

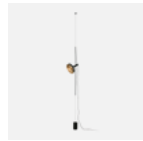

Whizz
214



Kombo
216



Nina
218



Plat
218

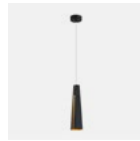

Pluma
220



Marisol
220

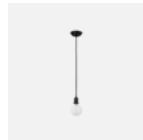

Art
228



Diana
230



Lina
232



Anna
232

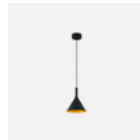

Pam
234



Stan
236

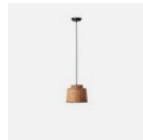

Saipan
248

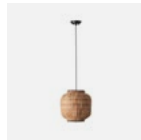

Tupai
248

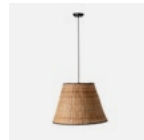

Sumba
248

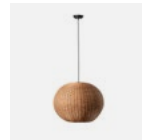

Haka
250

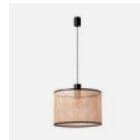

Mambo
252



Savoy
254



Saigon
264

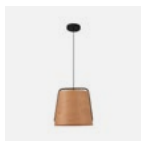

Stood
266

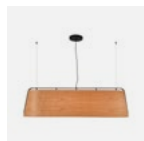

Stood
266



Tatawin
268



Liggera
272

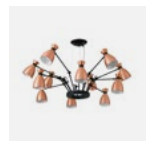

Retro
272

Ceiling

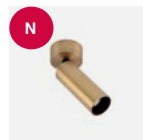

Stan Slim
290

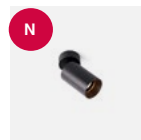

Stan
292



Leo
296



Link
298



Orleans
298



Stan
300



Shoku
314

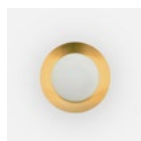

Side
316



Dolme
318



Cocotte
318



Mega
320



Bic
320



Isabelle
196



Tatawin
198

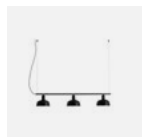

Tatawin
202



Studio
206



Studio
208

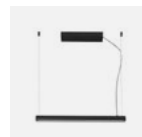

Vico
210

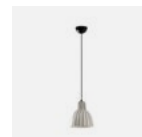

Venice
212



Whizz
214

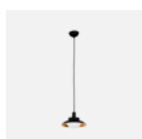

Side
220

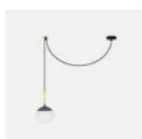

Mine
222

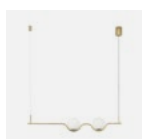

Le Vita
224

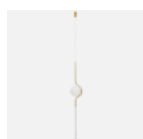

Le Vita
224

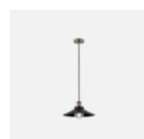

Marlin
226

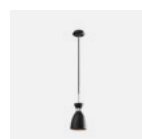

Retro
226

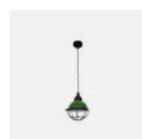

Claire
226

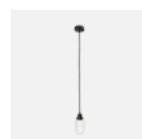

Brume
228

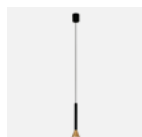

Danka
236



Cocotte
238

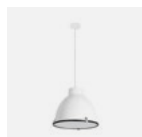

Charlotte
240

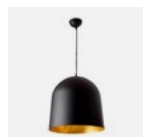

Crater
240

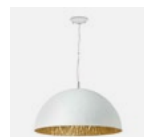

Magma
240

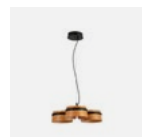

Loop
242



Confetti
244

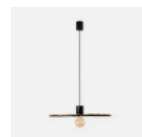

Costas
246

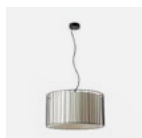

Linda
254

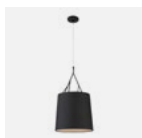

Tree
254

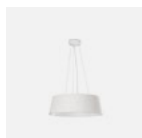

Aina
256

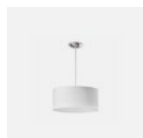

Seven
256



Vesper
258

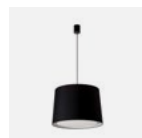

Conga
258

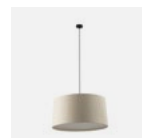

Samba
260



Windsor
262



Mine
274

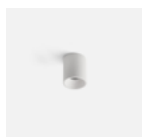

Rol
302



Sven
304



Mizu
306

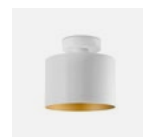

Janet
308



Tecto
308



Amelia
310

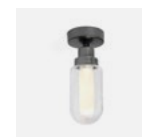

Brume
310



Tender
312



Seven
322



Aris
324



Foro
326

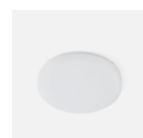

Zon
326



Vuk
326











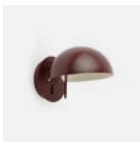



















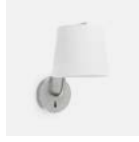













Logos
328

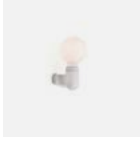
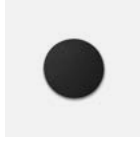
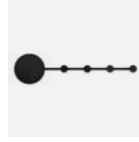
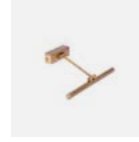
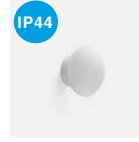

Tola
329

Wall

					
Matilda 332	Matilda 332	Tatawin 334	Venice 336	Studio 338	Dominica 340
					
Snap 360	Maya 362	Tatawin 368	Martinica 370	Dominica 372	Inviting 374
					
Windsor 416	Samba 418	Savoy 420	Conga 422	Sumba 424	Mambo 426
					
Fold 438	Room 440	Vesper 442	Berni 444	Handy 444	Nila 446
					
Stan 472	Nash 474	Kappu 478	Trama 482	Milo 484	Oslo 486
					
Kamen 494	Oton 496	Cotton 500	Stood 504	Linda 504	Diula 506
					
Kera 520	Sera 520	Board 522	Han 524	Magritte 526	Nubo 528
					
Tide 538	Volga 540	Kiva 542	Danubio 544	Nilo 546	



Guadalupe
342



Inviting
346



Academy
346



Liggera
348



Noon
354



Smile
354



Stan Slim
358



Retro
360



Celia
374

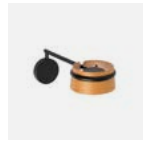

Loop
376



Pure
376



Whizz
378



Whizz
378



Cata
408



Dome
412



Dome
414



Luang
428

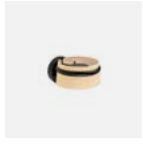

Loop
428



Lupe
430



Ron
430



Eterna
432



Rem
434



Frame
436



Artis
448



Sahara
450



Roda
450



Novo
460



Eres
462



Homs
462



Ovo
464



Sole
468



Lune
470



Olaf
486



Chera
488



Eaco
490



Snow
492



Elsa
492



Cove
492



Tera
494

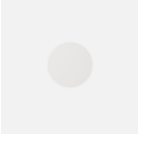

Luna
494

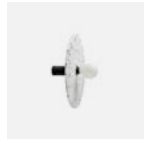

Confetti
508



Costas
510



Isabelle
512



May
514

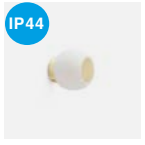

Moy
516



Le Vita
516



Ten
518



Joy
520



Mabe
530



Perla
530



Lago
532



Ping
532

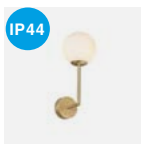

Gala
534



Bianca
534



















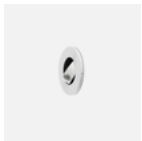





Brume
534

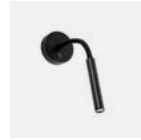





Calma
536



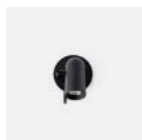
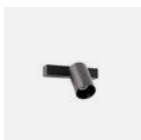

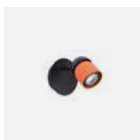



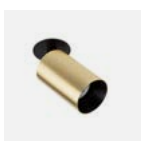
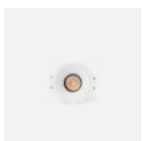

Reader

					
Dominica 340	Guadalupe 342	Tila 344	Aurea 350	Le Petit 350	Corb 352
					
Gabo 386	Duas 388	Click 388	Suau 390	Suau 392	Rob 394
					
Flin 402	Boken 404	Bel 404	Leser 406	Kale 406	Lead 406
					
Eterna 432	Rem 434	Frame 436	Fold 438	Room 440	

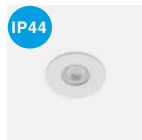

Spot

					
Orleans 361	Stan 452	Link 454	Coco 456	Stone 457	Lao 457

Recessed

 N					 N IP44
Stan Slim 294	Stan 294	Lox 550	Fox 552	Tast 556	Kivi 558
		 IP44	 IP44	 N IP44	
Gas 588	Neu 588	Wet 582	Moist 582	Niva 584	Dop 590

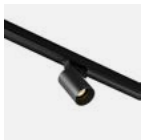
Track

 N		
Stan Slim 600	Stan 602	Leo 604



Well
352

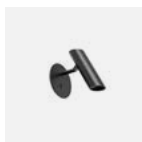

Leo
356



Stan
358



Niko
364



Nit
366



Dante
380



Cronos
382

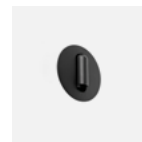

Timit
384

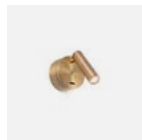

Boc
394

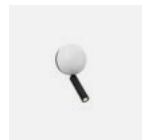

Press
394



Klee
396



Mood
398

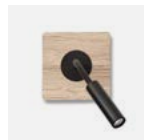

Mood
398



Pixie
400



Loke
400



Juliet
402



Dome
412



Windsor
416



Samba
418



Savoy
420



Conga
422



Sumba
424

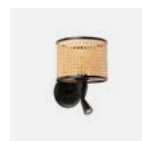

Mambo
426



Lupe
430



Vesper
442



Berni
444



Nila
446



Rob
448



Montreal
448



Artis
448



Nais
560



Flic
562



Flac
564

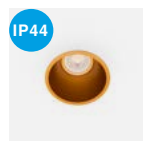

Fresh
566



Hyde
572



Radón
576

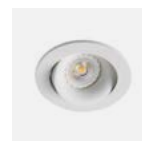

Argón
578

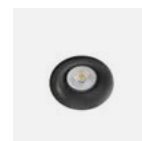

Neon
580



Luan
592

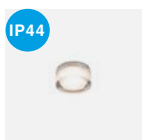

Ebba
592



Navi
594

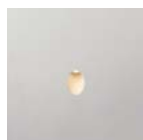

Tuk
594



Plas
594

Conga
Faro Lab



Table
P. 126



Floor
P. 126



Ceiling
P. 258



Ceiling
P. 282



Wall
P. 422

Cata
Marina Milá



Table
P. 42



Wall
P. 408



Ceiling
P. 188

Dome
Faro Lab



Table
P. 70



Floor
P. 72

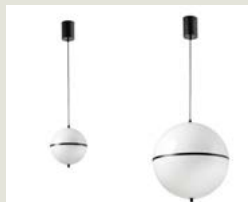

Ceiling
P. 192



Ceiling
P. 194



Wall
P. 412



Wall
P. 414

Dominica
Faro Lab



Table
P. 88



Floor
P. 88



Wall
P. 340



Wall
P. 372



Wall
P. 372

Guadalupe
Faro Lab



Table
P. 98



Floor
P. 98



Wall
P. 342

Inviting
Bohman And
Folienius



Table
P. 150



Clip-on
P. 164



Wall
P. 346



Wall
P. 374

Lao
Nahtrang



Table
P. 104



Floor
P. 104



Wall
P. 457

Leo
Estudi Ribaudí



Table
P. 92



Floor
P. 92



Ceiling
P. 296



Wall
P. 356



Track
P. 604

Le Vita
Nahtrang



Table
P. 106



Floor
P. 106



Ceiling
P. 224



Ceiling
P. 224



Wall
P. 516

Ligera



Table
P. 100



Floor
P. 100



Ceiling
P. 272



Wall
P. 348

Link
Estudi Ribaudí



Table
P. 102



Floor
P. 102



Ceiling
P. 298



Wall
P. 454

Loop
Estudi Ribaudí

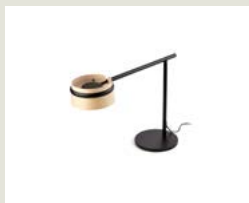
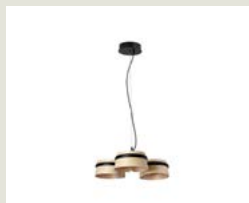

Table
P. 112



Floor
P. 112



Ceiling
P. 242



Wall
P. 376



Wall
P. 428

Luang
Faro Lab



Table
P. 108



Table
P. 108



Table
P. 108



Floor
P. 110



Wall
P. 428

Mambo
Faro Lab

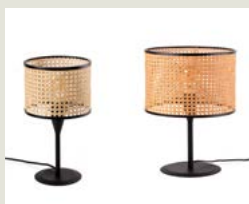
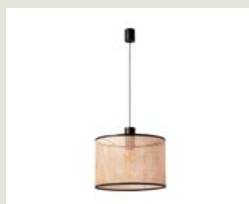

Table
P. 116



Floor
P. 116



Ceiling
P. 252



Ceiling
P. 281

Martinica
Faro Lab



Table
P. 90



Floor
P. 90

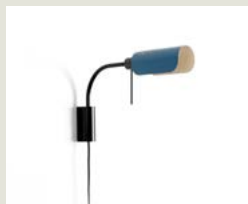

Wall
P. 370



Wall
P. 370

Matilda
Faro Lab



Table
P. 75



Floor
P. 76



Wall
P. 332



Wall
P. 332

Montreal
Nahrang



Table
P. 128



Floor
P. 128



Wall
P. 448

Nila



Table
P. 136



Floor
P. 136



Wall
P. 446



Wall
P. 446

Samba
Faro Lab



Table
P. 124



Floor
P. 124



Ceiling
P. 260



Ceiling
P. 282



Wall
P. 418

Savoy
Isaac Piñeiro



Table
P. 130



Floor
P. 130



Ceiling
P. 254



Wall
P. 420

Stan



Ceiling
P. 236

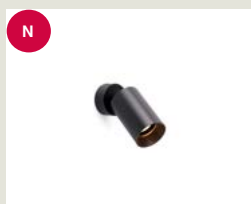

Wall
P. 292



Ceiling
P. 294



Wall
P. 452



Three-phase track
P. 602

Stan Slim



Recessed
P. 294



Ceiling
P. 290



Wall
P. 358



Track
P. 600

Stood
Lucid Product
Design



Table
P. 114



Floor
P. 114



Ceiling
P. 266



Ceiling
P. 266



Wall
P. 504

Studio
Nahtrang



Table
P. 96



Floor
P. 96



Clip-on
P. 166



Ceiling
P. 206



Ceiling
P. 208



Wall
P. 338

Tatawin
Adolfo Abejón



Table
P. 80



Floor
P. 82



Ceiling
P. 198



Ceiling
P. 202



Ceiling
P. 268



Ceiling
P. 284



Wall
P. 334



Wall
P. 368

Venice
Adolfo Abejón



Table
P. 86



Floor
P. 86



Ceiling
P. 212



Ceiling
P. 285



Wall
P. 336

Vesper
Nahtrng



Table
P. 138



Floor
P. 138



Ceiling
P. 258



Wall
P. 442



Wall
P. 442

Windsor
Faro Lab



Table
P. 120



Floor
P. 120



Ceiling
P. 262



Ceiling
P. 282



Wall
P. 416



Wall
P. 416

Our purpose is to contribute to the wellbeing and happiness of people through design and the relationship we establish with the objects that surround us in our daily lives. We believe in honest and accessible design. Nuestra razón de ser es contribuir al bienestar y la felicidad de las personas a través del diseño y la relación que establecemos con los objetos que nos acompañan en nuestro día a día. Creemos en un diseño honesto, accesible y cercano.

DESIGN FOR
EVERYONE

BRAND
WITH SOUL







Our sustainability journey focuses on minimizing our environmental footprint and maximizing our positive impact on society.

Nuestro camino hacia la sostenibilidad se centra en reducir nuestro impacto negativo en el planeta y maximizar nuestro impacto social positivo.

SUSTAINABILITY

TURN OFF THE LIGHT



Our impact report
Nuestro impacto



The expertise and knowledge of our professionals are dedicated to bringing your ideas to life, creating unique and functional spaces.

La experiencia y el conocimiento de nuestros profesionales se ponen al servicio de tus ideas para crear espacios únicos y funcionales.

SERVICES

YOUR IDEA, OUR EXPERTISE



Lighting & Fan projects / Proyectos de iluminación y ventilación
Control and connectivity / Control y conectividad
Customization and bespoke products / Personalización y productos a medida



Our commitment to quality is at the heart of everything we design. We rigorously control the quality of our products and services from conception to functionality and reliability testing. Nuestro compromiso con la calidad está presente en todo lo que diseñamos. Controlamos rigurosamente la calidad de nuestros productos y servicios desde la concepción hasta los ensayos de funcionalidad y fiabilidad.

FARO QUALITY LAB

QUALITY COMMITMENT



Quality management system based on ISO9001.

Compliance with electrical safety regulations under EN60598 (lighting) & EN60335 (fans), as well as ERP energy-efficiency requirements.

Sistema de gestión de calidad basado en la ISO9001.

Cumplimiento legislativo de las normativas de seguridad bajo la EN60598 (iluminación) y EN60335 (ventiladores de techo), así como la normativa de eficiencia energética ERP.

Parametrical Lab

Specification Compliance
Electrical Safety Tests
Integrating Sphere
Climatic Chamber
IK Tests
Endurance Test Room
Thermal Test Room

Environmental Testing Lab

Water IP Tests
Powder IP Tests
Salt Spray Chamber

Technical Assistance Service (TAS)

Customer Returns Analysis
Customer Returns Repairs
TAS Spare Parts

Quality inspections Lab

Batch inspections
Functional Tests
Product Assembly Control
Product Finish Control

Specification Compliance

Life Test
Customizations
Airflow measurements
Noise measurements

Goniophotometer Room

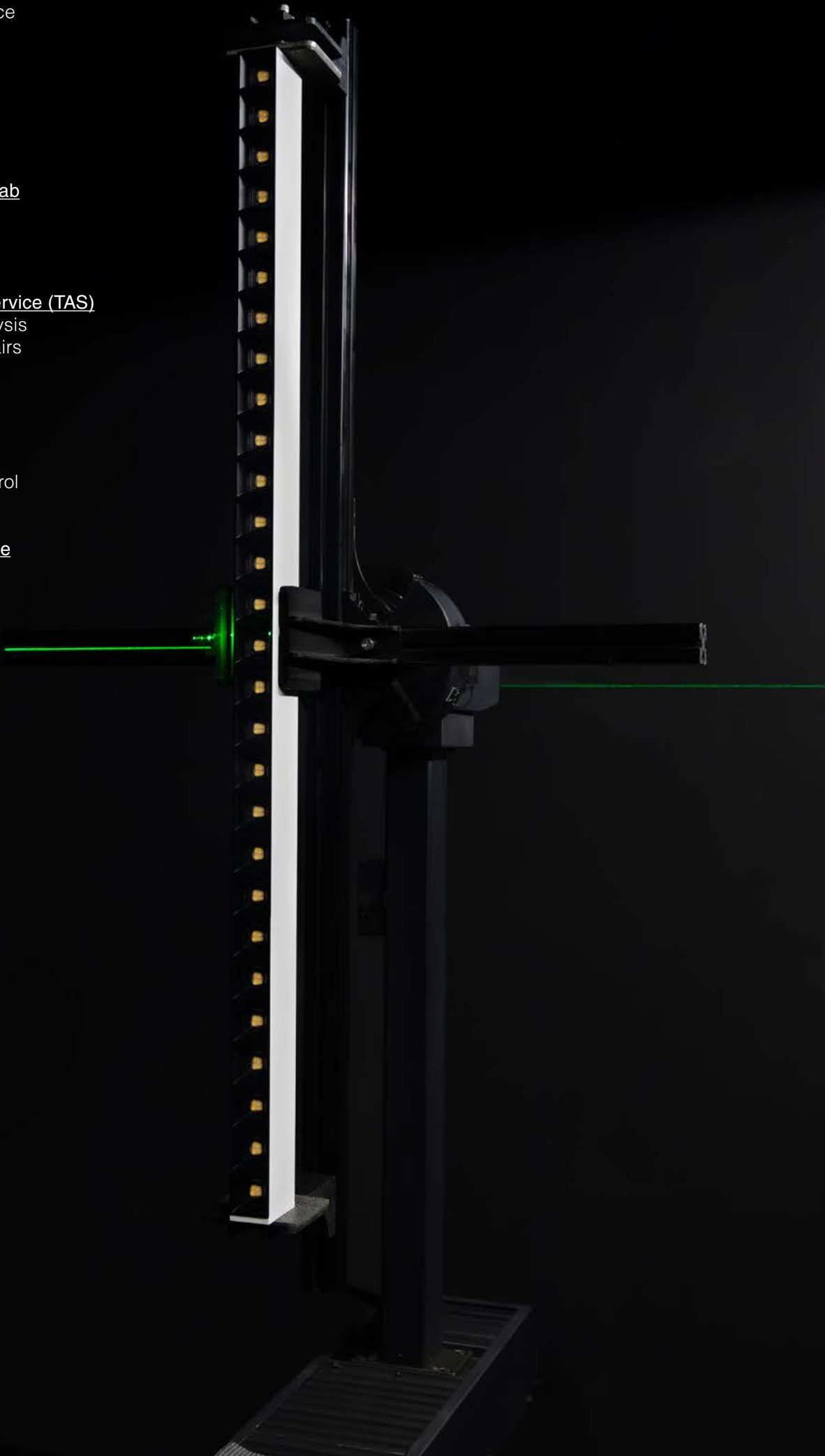



Together with PMMT Forward Thinking Architecture, we work to promote real inclusion. A selection of our designs carry the Clear Code Architecture© seal, ensuring that everyone can use them safely and comfortably, regardless of their circumstances. Junto a PMMT Forward Thinking Architecture, trabajamos para fomentar una inclusión real. Una selección de nuestros diseños cuentan con el sello Clear Code Architecture©, garantizando que todas las personas puedan utilizarlos de forma segura y cómoda, independientemente de sus circunstancias.

CLEAR CODE
ARCHITECTURE©

TOWARDS
UNIVERSAL
ACCESSIBILITY



Find out more
Descubre más

Clear Code Architecture® Groups

The Clear Code Architecture® method takes into account all diseases recognized by the WHO and complements them with others not recognized. In this way, 13 groups have been created that encompass all people with similar difficulties when using the physical environment, whether or not they have a disability.

Grupos del Clear Code Architecture®

El método Clear Code Architecture® tiene en cuenta todas las enfermedades reconocidas por la OMS y las complementa con otras no reconocidas. De esta manera, se han generado 13 grupos que engloban a todas las personas con dificultades similares en el uso del entorno físico, tengan o no una discapacidad.

	Group	Grupo
	1	Cannot see No puede ver
	2	Poor vision Ve poco
	3	Color blindness Confunde los colores
	4	Poor hearing Oye poco
	5	Use sign language Utiliza el lenguaje de signos
	6	Do not understand language No comprende el idioma
	7	Cannot walk No puede caminar
	8	Walk with great difficulty Camina con gran dificultad
	9	Walk with difficulty Camina con dificultad
	10	Limited manipulation Manipulación limitada
	11	Cognitive impairment Discapacidad cognitiva
	12	Short stature Estatura baja
	13	Hypersensitivity Hipersensibilidad



Universal accessibility
Silver





We continue expanding the reach of our lighting and fan solutions to more regions worldwide. A selection of our designs is available for 110V, US and Canadian markets, identified with this iconography.

Ampliamos el alcance de nuestras soluciones de iluminación y ventilación a más regiones de todo el mundo. Una selección de nuestros diseños está disponible para los mercados de 110V, Estados Unidos y Canadá, identificada con esta iconografía.



Light goes further. Air too.



Scan the QR codes to explore the selection.
Escanea los QR para ver la selección.



US & CA



110V





INDOOR

LIGHTING

PORTABLE

Buddy
 Andreu Carulla



- 20210 **Structure** Opal + Green
- 20209 **Structure** Opal + Blue
- 20208 **Structure** Opal + Dark Grey

Material	Structure PC
Power	3W
Lumen Output	276lm
Light Source	SMD LED 2700K
Class	III
CRI	>80
Voltage	5VDC
Battery	7 Charge Max. 10 Worktime

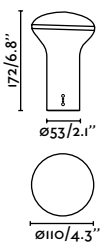

indoor

Portable



Fuji
Isaac Piñeiro

IP44  



0,5W/25lm

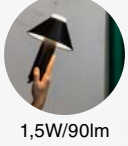

1W/45lm

1,5W/90lm

74465  **Structure** Satin Black
 **Diffuser** Opal

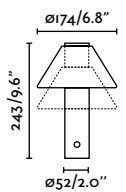

Material	Structure Aluminium + PC
	Shade Aluminium
	Diffuser PC
Power	1,5W
Lumen Output	68lm
Light Source	SMD LED 2700K
Dimmable W/lm	0,5/25-1/45-1,5/90
Class	III
CRI	>80
Voltage	5VDC
Battery	8 Charge Max. 10 Worktime



indoor

Portable



Take Away
Nahrang



01016 ● Structure Matt Black + Wood
● Diffuser White

Material	Structure ABS + Wood Diffuser TPU
Power	1,5W
Lumen Output	106lm
Light Source	COB LED 2700K
Dimmable W/lm	0,5/30-1/55-1,5/100
Class	III
CRI	>80
Voltage	5VDC
Battery	5 Charge Max. 5 Worktime

	Take Away Hook Accessory
01017	● Beech
Material	Structure Beech wood

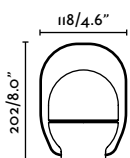

Its wooden accessory lets you mount it on the wall.

indoor

Portable





INDOOR

LIGHTING



TABLE & FLOOR

EMMANUELLE BERGOT

MAIWEIN LE BECCO

VALENT CASSEL

Cata Table
Marina Milá



- 20325 **Structure** Black Ash Wood
- Shade** Beige

- 20326 **Structure** Walnut Walnut Wood
- Shade** Beige

Material	Structure Wood
	Shade Papyrus
Power	2W
Lumen Output	91lm
Light Source	SMD LED 2200K
Class	II
CRI	85
Voltage	220V-240V/50/60Hz
Cable	1.5m

- Suspended**
188
- Surface**
408

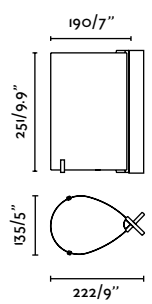



Cata combines warmth and sustainability, featuring a flat-pack design and certified sustainable wood (FSC® Certified wood), making it a perfect choice for cozy winter days.

Shan
Pepe Laudet



110V Check p. 30



20069 ● Structure Beige

Material	Structure Steel
	Shade Parchment
Light Source	1 E27 LED max. 15W
Bulb incl.	No
Recom. Bulb	17463
Class	II
Cable	2.1m

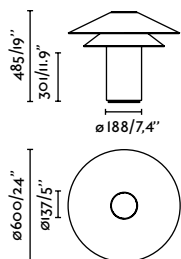













Composed of three handmade parchment shades, its essence is inspired by the architecture and materials of Japanese zen culture. Shan transcends time and fashion.

110V Check p. 30



- 28387  **Structure** Satin Gold + Matt Black
 **Diffuser** Opal
- 28388  **Structure** Matt Black + Copper
 **Diffuser** Opal
- 28350  **Structure** Gloss Black
 **Diffuser** Opal
- 28351  **Structure** Gloss Blue
 **Diffuser** Opal
- 28352  **Structure** Gloss Garnet
 **Diffuser** Opal

Material	Structure Steel
	Diffuser PC
Power	12W
Lumen Output	782lm
Light Source	SMD LED 2700K
Class	II
CRI	>80
Voltage	100V-240V/50/60Hz
Cable	2m

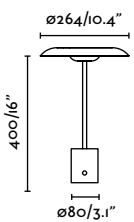



Moy Table
Nahtrang



- 40065 ● **Structure** Matt Black
● **Shade** Opal

Material	Structure Steel
	Shade Glass
Power	4W
Lumen Output	260lm
Light Source	SMD LED 2700K
Class	II
CRI	>80
Voltage	100V-240V/50/60Hz
Cable	1.8m



Amelia Table
Héctor Serrano



- 28430 ● **Structure** Matt White
● **Diffuser** Opal
- 28431 ● **Structure** Matt Black
● **Diffuser** Opal

Material	Structure Steel
	Diffuser Glass
Light Source	1 E27 LED max. 15W
Bulb incl.	No
Recom. Bulb	17528
Class	II
Cable	1.5m

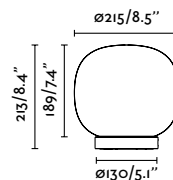
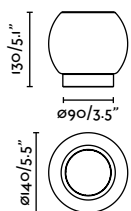



A calm lamp that blends into the space and uplifts it delicately all at once.

Niko Glass Table
Nahtrang



110V Check p. 30



01007A

- Structure Matt White + Wood
- Diffuser Opal

Niko PC Table
Nahtrang



110V Check p. 30



01025A

- Structure Matt White + Wood
- Diffuser Opal

Material	Structure Aluminium + Wood
	Diffuser Glass
Power	7W
Lumen Output	500lm
Light Source	SMD LED 3000K
Dimmable W/lm	1/80-4/250-7/500
Class	II
CRI	>80
Voltage	100V-240V/50/60Hz

Material	Structure Aluminium + Wood
	Diffuser PC
Power	7W
Lumen Output	500lm
Light Source	SMD LED 3000K
Dimmable W/lm	1/80-4/250-7/500
Class	II
CRI	>80
Voltage	100V-240V/50/60Hz



Wall
364

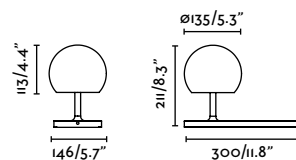
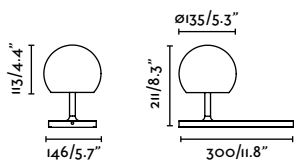



Ten Table
Faro Lab



110V Check p. 30



- 62156 Structure Gloss Copper
- 62157 Structure Satin Gold
- 62168 Structure Matt White
- 62169 Structure Matt Black

Material	Structure Steel
Light Source	1 E27 LED max. 15W
Bulb incl.	No
Recom. Bulb	17464
Class	II
Cable	1.5m



Wall
518

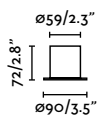

Mine PC Table
Nahrang



110V Check p. 30



- 28211 Structure Matt White
+ Beech
 Diffuser Opal
- 28212 Structure Dark Grey
+ Beech
 Diffuser Opal

Material	Structure Aluminium + Beech wood
	Diffuser PC
Light Source	1 E27 LED max. 15W
Bulb incl.	No
Recom. Bulb	17463
Class	II
Cable	1.8m

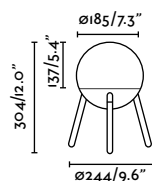

Mine Glass Table
Nahrang



110V Check p. 30



- 28378 Structure Matt White
+ Beech
 Diffuser Opal
- 28379 Structure Dark Grey
+ Beech
 Diffuser Opal

Material	Structure Aluminium + Beech wood
	Diffuser Glass
Light Source	1 E27 LED max. 15W
Bulb incl.	No
Recom. Bulb	17463
Class	II
Cable	1.8m



Suspended
222

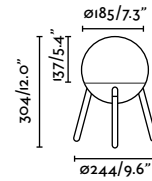



Moma Table



110V Check p. 30



- 68500 **Structure** Chrome
- Shade** White
- Diffuser** Opal

- 68501 **Structure** Chrome
- Shade** Black
- Diffuser** Opal

Material	Structure Steel
	Shade Textile
	Diffuser PC
Light Source	1 E27 LED max. 15W
Bulb incl.	No
Recom. Bulb	17463
Class	II
Cable	1.9m

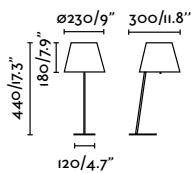

Sumba Table S

Faro Lab



ETL 110V Check p. 30



- 64317-71 **Structure** Matt Black
- Shade** Rattan

Material	Structure Steel
	Shade Rattan
Light Source	1 E27 LED max. 15W
Bulb incl.	No
Recom. Bulb	17426
Class	II
Cable	1.5m

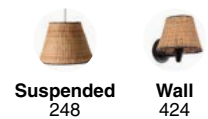
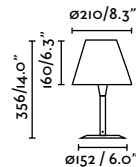



Lula S
Marina Milá



- 28380 **Structure** Matt White
- Shade** White

- 28382 **Structure** Matt Black
- Shade** White

Material	Structure Steel
	Shade Textile
Light Source	1 E27 LED max. 15W
Bulb incl.	No
Recom. Bulb	17463
Class	II
Cable	1.7m

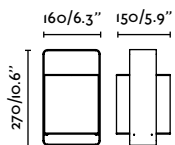

Lula M
Marina Milá



- 28383 **Structure** Matt White
- Shade** White

- 28385 **Structure** Matt Black
- Shade** White

Material	Structure Steel
	Shade Textile
Light Source	1 E27 LED max. 15W
Bulb incl.	No
Recom. Bulb	17463
Class	II
Cable	1.7m

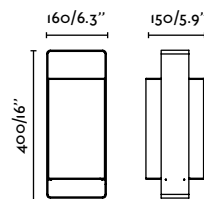



Staff
Faro Lab



- **Structure** Satin Black
- **Shade** Satin Black
- **Diffuser** Transparent



Material	Structure Steel
	Shade Aluminium
	Diffuser Glass
Power	26,5W
Lumen Output	2101lm
Light Source	COB LED 2700K
Class	II
CRI	90
Voltage	220V-240V/50/60Hz
Beam angle	109°
Cable	2m



Staff Gold Shade Accessory

24536 ● Matt Gold

Material **Structure** Aluminium

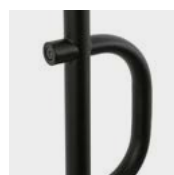
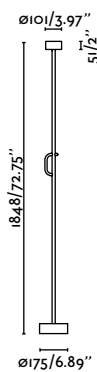

Push dimmer



Staff is an exploration of structural minimalism, inspired by the iconic halogen floor lamps of the '90s. A refined design that combines clean lines, modern technology, and high performance to offer a piece that is sober, functional, and surprisingly contemporary.

Treewood
Faro Lab



110V Check p. 30



20056 ●● Structure Ash Wood + Matt Black
● Shade Beige

Material	Structure Ash Wood + Steel
	Shade Parchment
Light Source	1 E27 LED max. 15W
Bulb incl.	No
Recom. Bulb	17464
Class	II
Cable	1.8m

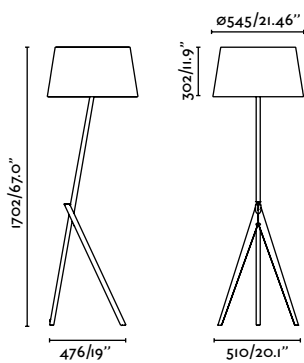

Treewood Tray
Faro Lab



110V Check p. 30



20057 ●● Structure Ash Wood + Matt Black
● Shade Beige

Material	Structure Ash Wood + Steel
	Shade Parchment
Light Source	1 E27 LED max. 15W
Bulb incl.	No
Recom. Bulb	17464
Class	II
Cable	1.8m

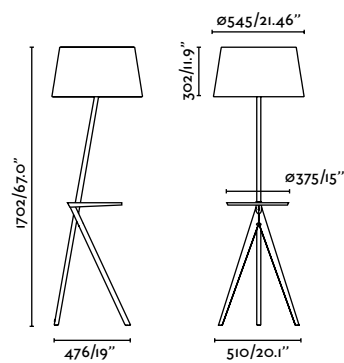



Stand Up

Estudi Ribaudí



110V Check p. 30



- 57211-01 ● Structure Matt Black
● Shade White
- 57211-03 ● Structure Matt Black
● Shade Grey
- 57211-04 ● Structure Matt Black
● Shade Off White Linen

Material	Structure Aluminium Shade Textilene
Light Source	1 E27 LED max. 15W
Bulb incl.	No
Recom. Bulb	17463
Class	II
Cable	2m

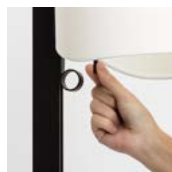
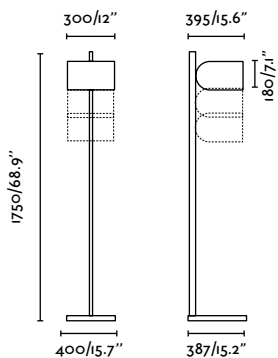

Whizz Floor

Christoph Friedrich Wagner



ETL 110V Check p. 30



- 20164-95 ● Structure Black
● Shade Black + Satin Gold
- 20164-96 ● Structure Black
● Shade Satin Gold + Black

Material	Structure Steel Shade Steel
Light Source	1 E27 LED max. 15W
Bulb incl.	No
Recom. Bulb	17496
Class	II
Cable	3.4m

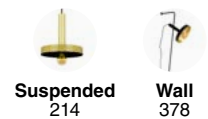
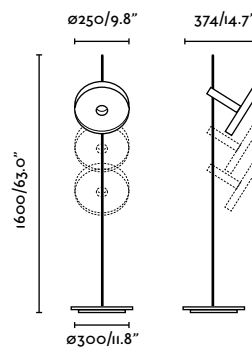



Guest
Andreu Carulla



110V Check p. 30



01046 ● Structure Matt Black

Material	Structure Steel
Light Source	1 E27 LED max. 15W
Bulb incl.	No
Recom. Bulb	17429
Class	II
Cable	1.8m

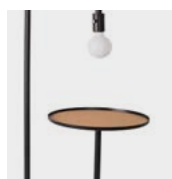
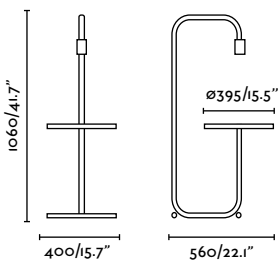

Cork tray
accessory included

Jellyfish Floor
Nahtrang



24521 ● Structure Matt Black + Matt Gold
● Diffuser Opal

Material	Structure Steel
	Diffuser PMMA
Power	6W
Lumen Output	136lm
Light Source	SMD LED 3000K
Class	II
CRI	>80
Voltage	220V-240V/50/60Hz
Cable	4.3m

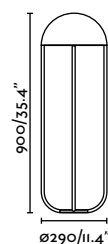



Black



110V Check p. 30



29764 ● **Structure** Gloss Black
● **Shade** Black

Material	Structure Steel
	Shade Textile
Light Source	1 E27 LED max. 15W
Bulb incl.	No
Recom. Bulb	17464
Class	II
Cable	2.5m

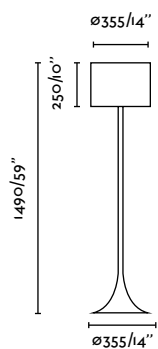

Papua



110V Check p. 30



68462 ● **Structure** Matt White
● **Shade** White
68463 ● **Structure** Matt Black
● **Shade** Black

Material	Structure Steel
	Shade Textile
Light Source	1 E27 LED max. 15W
Bulb incl.	No
Recom. Bulb	17464
Class	II
Cable	2m

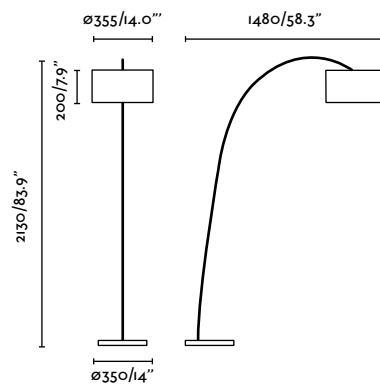





Dome

Designed by Faro Lab

Dome evokes the architectural minimalism of the '70s with a contemporary twist.



Dome 29913



Dome 29914

Dome Table S
Faro Lab



110V Check p. 30



NEW

29913 ● Structure Satin Black
● Shade Gloss White

Material	Structure Steel
	Shade PMMA
Light Source	1 E27 LED G45 max. 15W
Bulb incl.	No
Recom. Bulb	17524
Class	II
Cable	1.5m

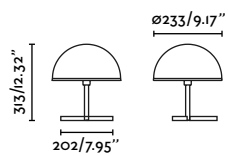

Dome Table M
Faro Lab



NEW

29914 ● Structure Satin Black
● Shade Gloss White

Material	Structure Steel
	Shade PMMA
Light Source	1 E27 LED G95 max. 20W
Bulb incl.	No
Recom. Bulb	17542
Class	II
Cable	1.5m

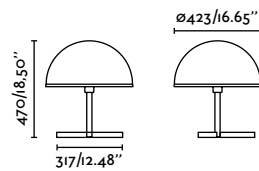

DIM
- +



The large table lamp and the floor version include dimming functionality, allowing the light to be adjusted to suit every moment or activity and to create tailored atmospheres.

Dome Floor
Faro Lab



29915 ● **Structure** Satin Black
● **Shade** Gloss White

Material	Structure Steel
	Shade PMMA
Light Source	1 E27 LED G95 max. 20W
Bulb incl.	No
Recom. Bulb	17542
Class	II
Cable	2m

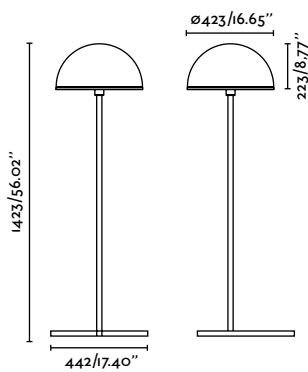
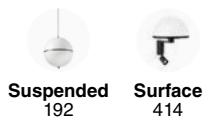





Matilda

Designed by Faro Lab

Its rotating shade system and height adjustment offer a wide variety of lighting effects, making it a multifunctional collection.



Matilda Table
Faro Lab



110V Check p. 30



- 20512-136 ● **Structure** Beige
- 20513-137 ● **Structure** Black
- 20514-138 ● **Structure** Garnet

Material	Structure Steel
	Shade Steel
Light Source	1 E14 LED G45 max. 15W
Bulb incl.	No
Recom. Bulb	17461
Class	II
Cable	2.5m

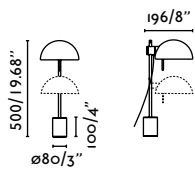
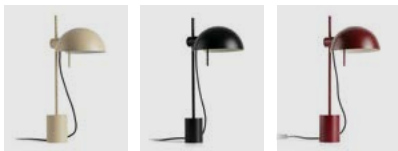

Matilda Floor
Faro Lab



110V Check p. 30



- 20516-136 ● **Structure** Beige
- 20517-137 ● **Structure** Black
- 20518-138 ● **Structure** Garnet

Material	Structure Steel
	Shade Steel
Light Source	1 E14 LED G45 max. 15W
Bulb incl.	No
Recom. Bulb	17461
Class	II
Cable	2.5m



Surface
332

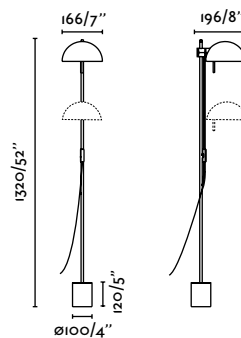



Tatawin

Designed by Adolfo Abejón



Tatawin 20337-116

The shape of the lampshade is reminiscent of the upper part of the characteristic houses of Tataouine, a city located in the south-east of Tunisia.





Tatawin Table Glass

Adolfo Abejón



20337-116 ● **Structure** Satin Black
● **Shade** Opal

20337-117 ● **Structure** Satin Black
● **Shade** Gloss Black

Material	Structure Steel
	Shade Glass
Light Source	1 E27 LED G45 max. 15W
Bulb incl.	No
Recom. Bulb	17462
Class	II
Cable	1.5m

Tatawin Table Metal

Adolfo Abejón

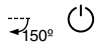

20337-140 ● **Structure** Satin Black
● **Shade** Gloss White

20337-141 ● **Structure** Satin Black
● **Shade** Gloss Black

20337-142 ● **Structure** Satin Black
● **Shade** Gloss Grayish Blue

20337-143 ● **Structure** Satin Black
● **Shade** Gloss Reddish Orange

20337-144 ● **Structure** Satin Black
● **Shade** Gloss Green

Material	Structure Steel
	Shade Steel
Light Source	1 E27 LED G45 max. 15W
Bulb incl.	No
Recom. Bulb	17462
Class	II
Cable	1.5m

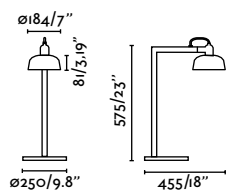

Adjustable structure



Tatawin Floor Glass

Adolfo Abejón



20336-119 ● **Structure** Satin Black
● **Shade** Opal

20336-120 ● **Structure** Satin Black
● **Shade** Gloss Black

Material	Structure Steel
	Shade Glass
Light Source	1 E27 LED max. 15W
Bulb incl.	No
Recom. Bulb	17463
Class	II
Cable	2m

Tatawin Floor Metal

Adolfo Abejón

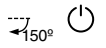

20336-145 ● **Structure** Satin Black
● **Shade** Gloss White

20336-146 ● **Structure** Satin Black
● **Shade** Gloss Black

20336-147 ● **Structure** Satin Black
● **Shade** Gloss Grayish Blue

20336-148 ● **Structure** Satin Black
● **Shade** Gloss Reddish Orange

20336-149 ● **Structure** Satin Black
● **Shade** Gloss Green

Material	Structure Steel
	Shade Steel
Light Source	1 E27 LED max. 15W
Bulb incl.	No
Recom. Bulb	17463
Class	II
Cable	2m

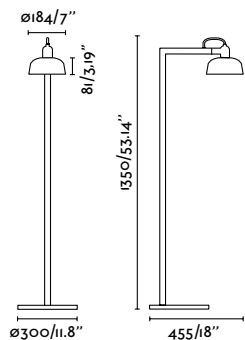
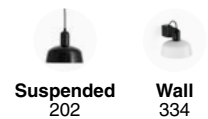

Adjustable structure





Venice

Designed by Adolfo Abejón

Following a traditional and manual process, the shade is produced by casting the ceramic.



Venice 64276-113

Venice Table
Adolfo Abejón



64276-115	● Structure Satin Black ● Shade Gloss Blue
64276-111	● Structure Satin Black ● Shade Gloss White
64276-112	● Structure Satin Black ● Shade Gloss Black
64276-114	● Structure Satin Black ▨▨▨ Shade White & Gloss Black
64276-113	● Structure Satin Black ● Shade Gloss Pink

Material	Structure Steel Shade Ceramic
Light Source	1 E27 LED max. 15W
Bulb incl.	No
Recom. Bulb	17463
Class	II
Cable	1.5m

Venice Floor
Adolfo Abejón

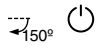

64275-115	● Structure Satin Black ● Shade Gloss Blue
64275-111	● Structure Satin Black ● Shade Gloss White
64275-112	● Structure Satin Black ● Shade Gloss Black
64275-114	● Structure Satin Black ▨▨▨ Shade White & Gloss Black
64275-113	● Structure Satin Black ● Shade Gloss Pink

Material	Structure Steel Shade Ceramic
Light Source	1 E27 LED max. 15W
Bulb incl.	No
Recom. Bulb	17463
Class	II
Cable	2m

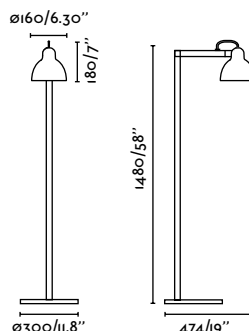
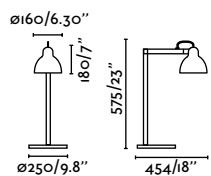
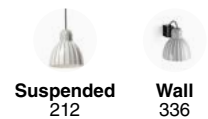



Dominica Table
Faro Lab



- 20033-122 ● Structure Black
● Shade Beige
- 20033-123 ● Structure Black
● Shade Black

Material	Structure Steel Shade Steel
Light Source	1 E27 LED max. 15W
Bulb incl.	No
Recom. Bulb	17463
Class	II
Cable	1.5m

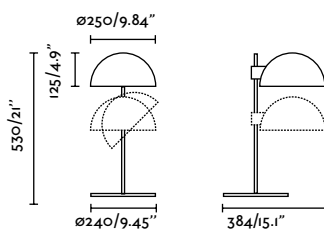

Dominica Floor
Faro Lab



- 20034-122 ● Structure Black
● Shade Beige
- 20034-123 ● Structure Black
● Shade Black

Material	Structure Steel Shade Steel
Light Source	1 E27 LED max. 15W
Bulb incl.	No
Recom. Bulb	17463
Class	II
Cable	3.5m

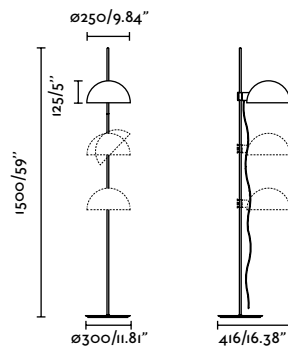

Wall
340



Martinica Table

Faro Lab



20033-133 ● Structure Black
● Shade Black

20033-134 ● Structure Black
● Shade Blue

20033-135 ● Structure Black
● Shade Beige

Material	Structure Steel
	Shade Steel
Light Source	1 E27 LED ST64 max. 15W
Bulb incl.	No
Recom. Bulb	17428
Class	II
Cable	1.5m

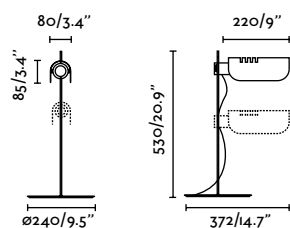

Martinica Floor

Faro Lab



20034-133 ● Structure Black
● Shade Black

20034-134 ● Structure Black
● Shade Blue

20034-135 ● Structure Black
● Shade Beige

Material	Structure Steel
	Shade Steel
Light Source	1 E27 LED ST64 max. 15W
Bulb incl.	No
Recom. Bulb	17428
Class	II
Cable	3.5m

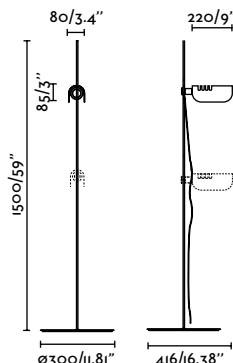

Surface
370



Leo Table
Estudi Ribaudí

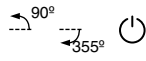

- 43796 Structure Matt White
- 43797 Structure Matt Black

Material	Structure Aluminium
Power	3,5W
Lumen Output	299lm
Light Source	COB LED 2700K
Class	II
CRI	≥90
Voltage	220V-240V/50/60Hz
Cable	2m

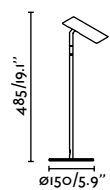

Leo Floor
Estudi Ribaudí

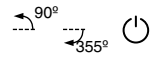

- 43798 Structure Matt White
- 43799 Structure Matt Black

Material	Structure Aluminium
Power	3,5W
Lumen Output	299lm
Light Source	COB LED 2700K
Class	II
CRI	≥90
Voltage	220V-240V/50/60Hz
Cable	2m

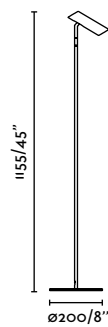

Track
604



Wall
356



Ceiling
296





Studio

Designed by Nahtrang

Studio brings back lines of the 1950s and reinterprets them to fit into a modern context.



Studio Table Nahrang



110V Check p. 30



28251	● Structure Matt Black ● Shade Matt Black
28252	● Structure Matt Black ● Shade Matt White
28253	● Structure Matt Black ● Shade Matt Green
28269	● Structure Matt Black ● Shade Matt Blue
28270	● Structure Matt Black ● Shade Matt Pink

Material	Structure Steel Shade Steel
Light Source	1 E14 LED max. 8W
Bulb incl.	No
Recom. Bulb	17461
Class	II
Cable	1.8m



Clear Code
Architecture
INSPIRED BY FORM

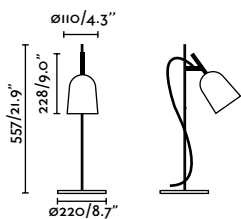

Studio Floor Nahrang

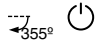

110V Check p. 30



28254	● Structure Matt Black ● Shade Matt Black
28255	● Structure Matt Black ● Shade Matt White
28256	● Structure Matt Black ● Shade Matt Green
28271	● Structure Matt Black ● Shade Matt Blue
28272	● Structure Matt Black ● Shade Matt Pink

Material	Structure Steel Shade Steel
Light Source	1 E14 LED max. 8W
Bulb incl.	No
Recom. Bulb	17461
Class	II
Cable	2.3m



Clear Code
Architecture
INSPIRED BY FORM

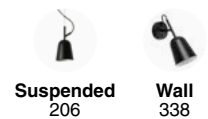
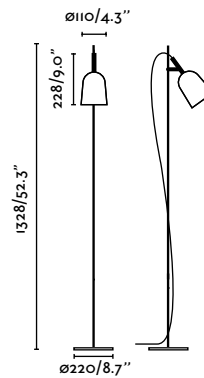

Suspended
206

Wall
338



Guadalupe Table

Faro Lab

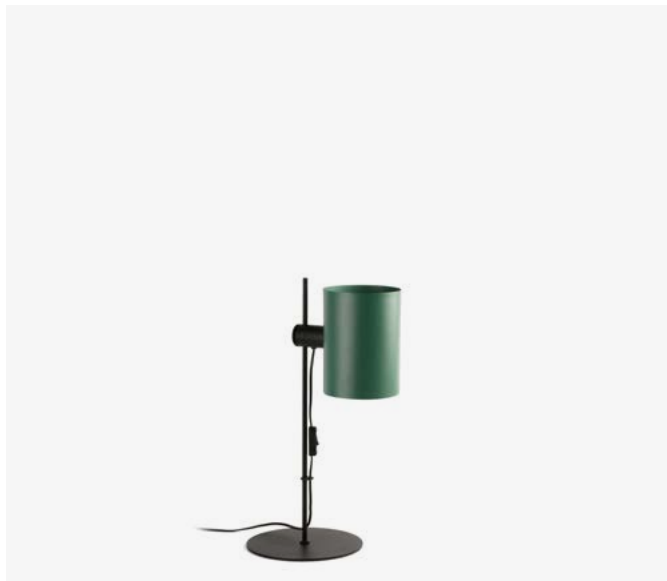

20033-80 ● **Structure** Matt Black
● **Shade** Beige

20033-81 ● **Structure** Matt Black
● **Shade** Green

Material	Structure Steel
	Shade Steel
Light Source	1 E27 LED max. 15W
Bulb incl.	No
Recom. Bulb	17463
Class	II
Cable	1.5m

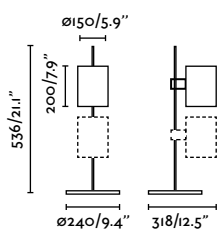

Guadalupe Floor

Faro Lab



20034-80 ● **Structure** Matt Black
● **Shade** Beige

20034-81 ● **Structure** Matt Black
● **Shade** Green

Material	Structure Steel
	Shade Steel
Light Source	1 E27 LED max. 15W
Bulb incl.	No
Recom. Bulb	17463
Class	II
Cable	3.5m

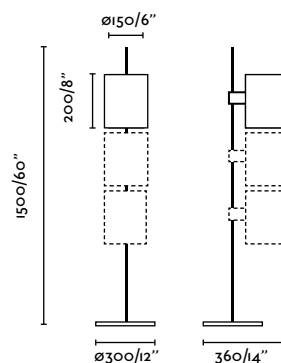

Wall
342



Liggera Table



110V Check p. 30



20076 ● Structure Matt Black

Material	Structure Steel
	Shade Steel
Light Source	1 G9 LED max. 6W
Bulb incl.	No
Recom. Bulb	17466
Class	II
Cable	1.8m

Liggera Floor



110V Check p. 30



20075 ● Structure Matt Black

Material	Structure Steel
	Shade Steel
Light Source	1 G9 LED max. 6W
Bulb incl.	No
Recom. Bulb	17466
Class	II
Cable	2.2m

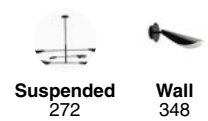
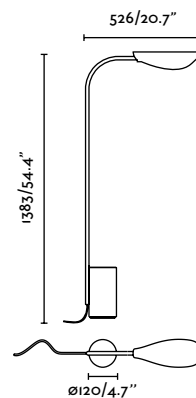
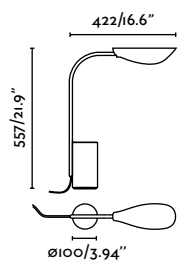



Link Table
Estudi Ribaudí

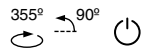

110V Check p. 30



- 29881 Structure Matt White
- 29882 Structure Matt Black
- 29898 Structure Bronze

Material	Structure Steel
Light Source	1 GU10 LED max. 8W
Bulb incl.	No
Recom. Bulb	17324
Class	II
Cable	1.9m

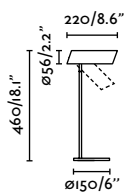

Link Floor
Estudi Ribaudí



110V Check p. 30



- 29883 Structure Matt White
- 29884 Structure Matt Black
- 29899 Structure Bronze

Material	Structure Steel
Light Source	1 GU10 LED max. 8W
Bulb incl.	No
Recom. Bulb	17324
Class	II
Cable	1.9m

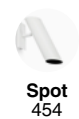
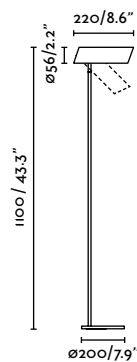



Lao Table
Nahtrang

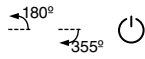

110V Check p. 30



29047 ●● Structure Matt Black + Gloss Black
● Diffuser Opal

Lao Floor
Nahtrang

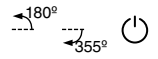

110V Check p. 30



29049 ●● Structure Matt Black + Gloss Black
● Diffuser Opal

Material	Structure Aluminium + ABS
	Diffuser PMMA
Power	4W
Lumen Output	400lm
Light Source	SMD LED 3000K
Class	II
CRI	>80
Voltage	100V-240V/50/60Hz
Cable	2m

Material	Structure Aluminium + ABS
	Diffuser PMMA
Power	4W
Lumen Output	400lm
Light Source	SMD LED 3000K
Class	II
CRI	>80
Voltage	100V-240V/50/60Hz
Cable	2m



Spot
361

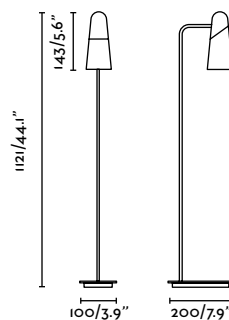
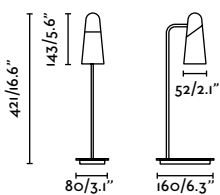



Le Vita Table
Nahtrang



- 29692D ● **Structure** Gloss Gold
● **Diffuser** Opal

- 29697 ● **Structure** Matt Black
● **Diffuser** Opal

Material	Structure Steel
	Diffuser Glass
Power	7W
Lumen Output	570lm
Light Source	SMD LED 2700K
Dimmable W/lm	1/95-4/380-6/570
Class	II
CRI	>80
Voltage	220V-240V/50/60Hz
Cable	2m

Le Vita Floor
Nahtrang



- 29693D ● **Structure** Gloss Gold
● **Diffuser** Opal

- 29698 ● **Structure** Matt Black
● **Diffuser** Opal

Material	Structure Steel
	Diffuser Glass
Power	7W
Lumen Output	570lm
Light Source	SMD LED 2700K
Dimmable W/lm	1/95-4/380-6/570
Class	II
CRI	>80
Voltage	220V-240V/50/60Hz
Cable	2m

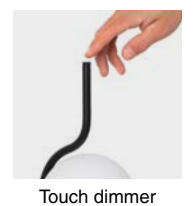
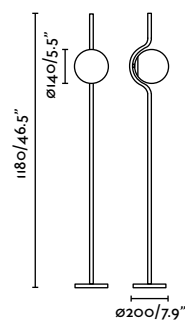
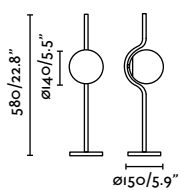
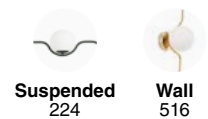



indoor

Table&Floor



Its glass diffuser offers a homogeneous and dim light, avoiding glare.

Luang Table XS
Faro Lab



110V Check p. 30

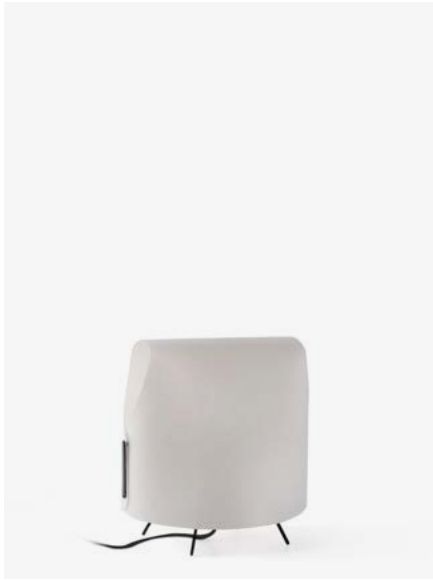

- 23065 ● Structure Black
● Shade Beige
- 23066 ● Structure Black
● Shade Camel

Material	Structure Steel
	Shade Parchment
Light Source	1 E14 LED max. 8W
Bulb incl.	No
Recom. Bulb	17461
Class	II
Cable	1.5m

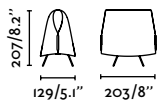

Luang Table S
Faro Lab



110V Check p. 30



- 23001-57 ● Structure Black
● Shade Beige
- 23001-58 ● Structure Black
● Shade Camel

Material	Structure Steel
	Shade Parchment
Light Source	1 E27 LED max. 15W
Bulb incl.	No
Recom. Bulb	17462
Class	II
Cable	1.9m

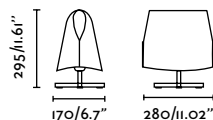

Luang Table M
Faro Lab



ETL 110V Check p. 30



- 23002-57 ● Structure Black
● Shade Beige
- 23002-58 ● Structure Black
● Shade Camel

Material	Structure Steel
	Shade Parchment
Light Source	1 E27 LED max. 15W
Bulb incl.	No
Recom. Bulb	17463
Class	II
Cable	1.9m

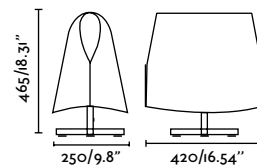



Luang Floor
Faro Lab



Flat pack

- 23003-59 ● **Structure** Black
● **Shade** Beige
- 23003-60 ● **Structure** Black
● **Shade** Camel

Material	Structure Steel
	Shade Parchment
Light Source	1 E27 LED max. 15W
Bulb incl.	No
Recom. Bulb	17463
Class	II
Cable	1.8m



Wall
428

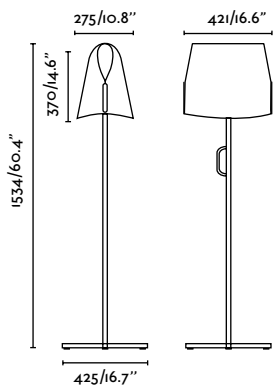



Loop Table
Estudi Ribaudí

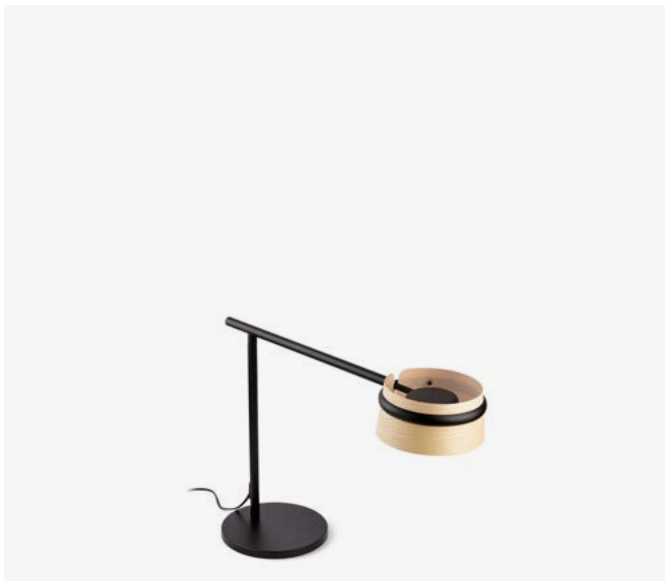
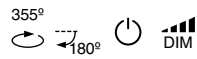

- 29398
 - Structure Matt Black
 - Shade Ash Wood
 - Diffuser Translucent
- 29568
 - Structure Matt Black
 - Shade Cherry Wood
 - Diffuser Translucent

Loop Floor
Estudi Ribaudí

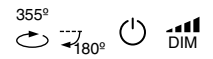

- 29399
 - Structure Matt Black
 - Shade Ash Wood
 - Diffuser Translucent
- 29569
 - Structure Matt Black
 - Shade Cherry Wood
 - Diffuser Translucent

Material	Structure Steel
	Shade Wood
	Diffuser PMMA
Power	6W
Lumen Output	221lm
Light Source	SMD LED 2700K
Class	II
CRI	>80
Voltage	220V-240V/50/60Hz
Cable	2m

Material	Structure Steel
	Shade Wood
	Diffuser PMMA
Power	6W
Lumen Output	221lm
Light Source	SMD LED 2700K
Class	II
CRI	>80
Voltage	220V-240V/50/60Hz
Cable	2m

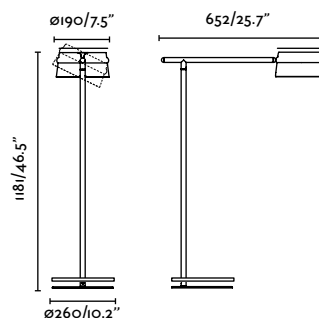
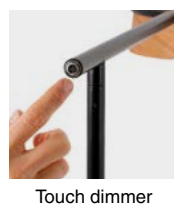
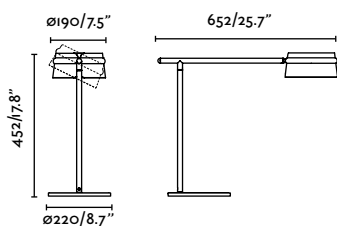
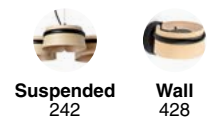



Stood Table
Lucid Product Design



29846 ● **Structure** Matt Black
● **Shade** Cherry Wood

Material	Structure Steel
	Shade Cherry Wood
Light Source	1 E27 LED max. 15W
Bulb incl.	No
Recom. Bulb	17464
Class	II
Cable	2m

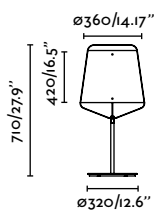

Stood Floor
Lucid Product Design



29847 ● **Structure** Matt Black
● **Shade** Cherry Wood

Material	Structure Steel
	Shade Cherry Wood
Light Source	1 E27 LED max. 15W
Bulb incl.	No
Recom. Bulb	17464
Class	II
Cable	2m

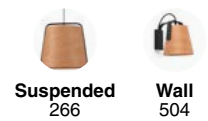
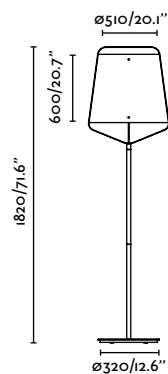



Mambo Table S
Faro Lab

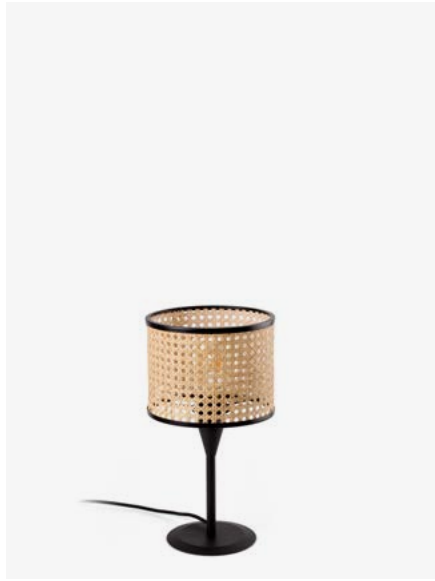

64317-47 ● Structure Matt Black
● Shade Rattan

Mambo Table M
Faro Lab



64311-48 ● Structure Matt Black
● Shade Rattan

Mambo Floor
Faro Lab



64313-49 ● Structure Matt Black
● Shade Rattan

Material	Structure Steel
	Shade Rattan
Light Source	1 E27 LED max. 15W
Bulb incl.	No
Recom. Bulb	17463
Class	II
Cable	1.5m

Material	Structure Steel
	Shade Rattan
Light Source	1 E27 LED max. 15W
Bulb incl.	No
Recom. Bulb	17463
Class	II
Cable	1.5m

Material	Structure Steel
	Shade Rattan
Light Source	1 E27 LED max. 15W
Bulb incl.	No
Recom. Bulb	17464
Class	I
Cable	1.8m

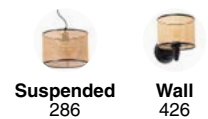
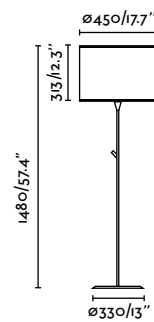
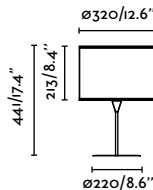
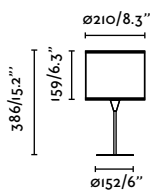



Akane 350
Pepe Llaudet



28370 ● **Structure** Matt Black
● **Shade** Beige

Material	Structure Steel
	Shade Parchment
Light Source	1 E27 LED max. 15W
Bulb incl.	No
Recom. Bulb	17463
Class	II
Cable	1.7m

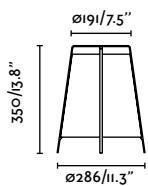

Akane 595
Pepe Llaudet



28371 ● **Structure** Matt Black
● **Shade** Beige

Material	Structure Steel
	Shade Parchment
Light Source	1 E27 LED max. 15W
Bulb incl.	No
Recom. Bulb	17464
Class	II
Cable	1.7m

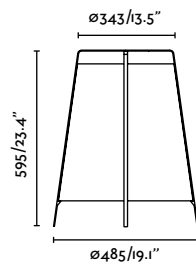

indoor

Table&Floor



With a parchment diffuser, it is inspired by the traditional lanterns of the Far East.

Akane 28370

Windsor Table

Faro Lab



20225-130 ● **Structure** Matt Black
● **Shade** Grey
● **Diffuser** Grey

20225-151 ● **Structure** Matt Black
● **Shade** Off White Linen
● **Diffuser** Off White

20226-151 ● **Structure** Matt White
● **Shade** Off White Linen
● **Diffuser** Off White

Material	Structure Steel
	Shade Textile
	Diffuser Textile
Light Source	1 E27 LED A60 max. 15W
Bulb incl.	No
Recom. Bulb	17463
Class	II
Cable	2m

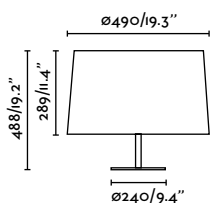

Textile diffuser

Windsor Floor

Faro Lab



20227-131 ● **Structure** Matt Black
● **Shade** Grey
● **Diffuser** Grey

20227-152 ● **Structure** Matt Black
● **Shade** Off White Linen
● **Diffuser** Off White

20228-152 ● **Structure** Matt White
● **Shade** Off White Linen
● **Diffuser** Off White

Material	Structure Steel
	Shade Textile
	Diffuser Textile
Light Source	1 E27 LED G95 max. 15W
Bulb incl.	No
Recom. Bulb	17464
Class	II
Cable	2m

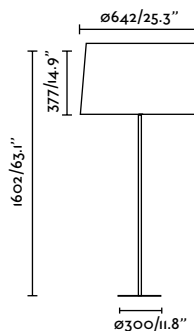

Textile diffuser

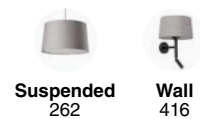



Windsor can create ambient lighting for large spaces, such as hotels and restaurants.

Drum Table

Nahtrang



- 24020-31
 - Structure Matt Black
 - Shade Beige
 - Diffuser Opal

- 24020-32
 - Structure Matt Black
 - Shade Dark Grey
 - Diffuser Opal

Material	Structure Steel
	Shade Textile
	Diffuser PC
Light Source	1 E27 LED max. 15W
Bulb incl.	No
Recom. Bulb	17463
Class	II
Cable	1.8m

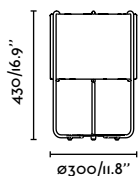

Drum Floor

Nahtrang



- 24023-33
 - Structure Matt Black
 - Shade Beige
 - Diffuser Opal

- 24023-34
 - Structure Matt Black
 - Shade Dark Grey
 - Diffuser Opal

Material	Structure Steel
	Shade Textile
	Diffuser PC
Light Source	1 E27 LED max. 15W
Bulb incl.	No
Recom. Bulb	17464
Class	II
Cable	2.1m

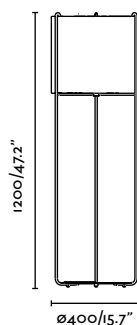

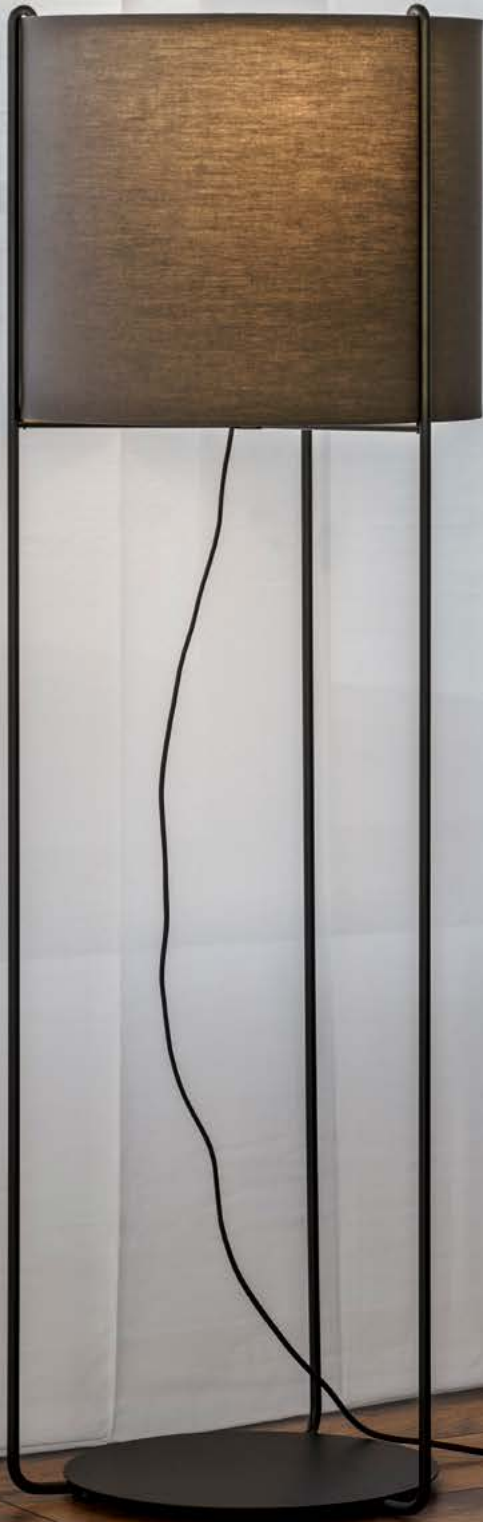

Samba Table S
Faro Lab



- 64316-35 Structure Matt White
 Shade Beige
- 64316-36 Structure Matt White
 Shade Yellow
- 64316-37 Structure Matt White
 Shade Green
- 64317-35 Structure Matt Black
 Shade Beige
- 64317-36 Structure Matt Black
 Shade Yellow
- 64317-37 Structure Matt Black
 Shade Green

Material	Structure Steel
	Shade Textile
Light Source	1 E27 LED max. 15W
Bulb incl.	No
Recom. Bulb	17463
Class	II
Cable	1.5m

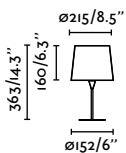

Samba Table M
Faro Lab



- 64310-38 Structure Matt White
 Shade Beige
- 64310-39 Structure Matt White
 Shade Yellow
- 64310-40 Structure Matt White
 Shade Green
- 64311-38 Structure Matt Black
 Shade Beige
- 64311-39 Structure Matt Black
 Shade Yellow
- 64311-40 Structure Matt Black
 Shade Green

Material	Structure Steel
	Shade Textile
Light Source	1 E27 LED max. 15W
Bulb incl.	No
Recom. Bulb	17463
Class	II
Cable	1.5m

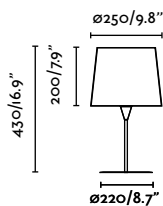

Samba Floor
Faro Lab



- 64312-41 Structure Matt White
 Shade Beige
- 64312-42 Structure Matt White
 Shade Yellow
- 64312-43 Structure Matt White
 Shade Green
- 64313-41 Structure Matt Black
 Shade Beige
- 64313-42 Structure Matt Black
 Shade Yellow
- 64313-43 Structure Matt Black
 Shade Green

Material	Structure Steel
	Shade Textile
Light Source	1 E27 LED max. 15W
Bulb incl.	No
Recom. Bulb	17464
Class	I
Cable	1.8m

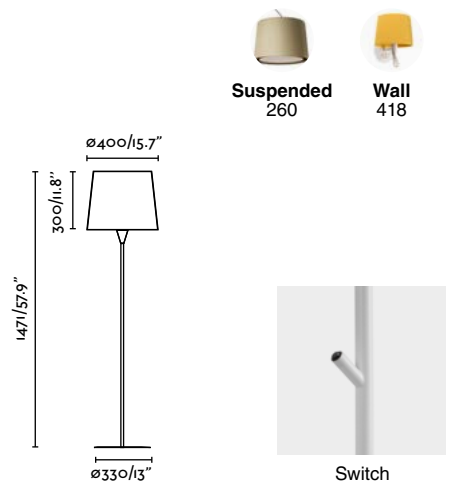



Samba 64312-41



Conga Table S
Faro Lab



- 64316-01 Structure Matt White
 Shade White
- 64316-02 Structure Matt White
 Shade Beige
- 64317-03 Structure Matt Black
 Shade Black

Material	Structure Steel
	Shade Textile
Light Source	1 E27 LED max. 15W
Bulb incl.	No
Recom. Bulb	17463
Class	II
Cable	1.5m

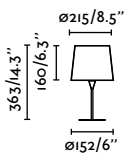

Conga Table M
Faro Lab



- 64310-04 Structure Matt White
 Shade White
- 64310-05 Structure Matt White
 Shade Beige
- 64311-06 Structure Matt Black
 Shade Black

Material	Structure Steel
	Shade Textile
Light Source	1 E27 LED max. 15W
Bulb incl.	No
Recom. Bulb	17463
Class	II
Cable	1.5m

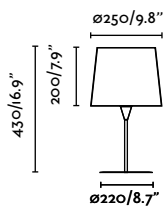

Conga Floor
Faro Lab



- 64312-07 Structure Matt White
 Shade White
- 64312-08 Structure Matt White
 Shade Beige
- 64313-09 Structure Matt Black
 Shade Black

Material	Structure Steel
	Shade Textile
Light Source	1 E27 LED max. 15W
Bulb incl.	No
Recom. Bulb	17464
Class	I
Cable	1.8m

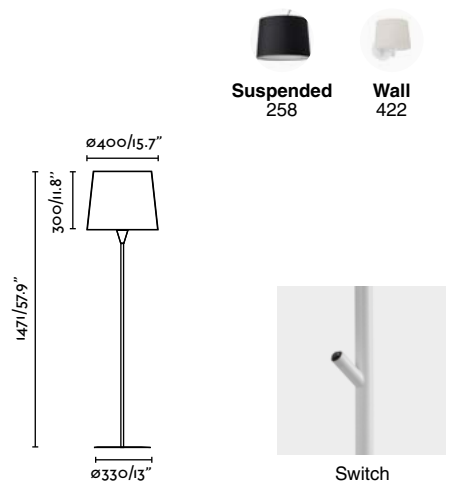



Montreal Table
Nahrang



110V Check p. 30



- 24034-04 **Structure** Matt White
 Shade White
- 24034-05 **Structure** Matt White
 Shade Beige

Material	Structure Steel
	Shade Textile
Light Source	1 E27 LED max. 15W
Bulb incl.	No
Recom. Bulb	17463
Class	II
Cable	1.8m

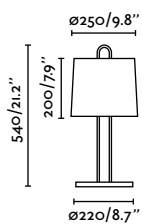

Montreal Floor
Nahrang



110V Check p. 30



- 24037-07 **Structure** Chrome
 Shade White
- 24037-08 **Structure** Chrome
 Shade Beige
- 24037-09 **Structure** Chrome
 Shade Black

Material	Structure Steel
	Shade Textile
Light Source	1 E27 LED max. 15W
Bulb incl.	No
Recom. Bulb	17464
Class	II
Cable	2.1m

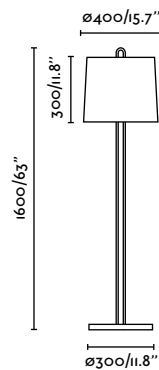

Wall
448



Savoy Table

Isaac Piñeiro



- 20304-82 **Structure** Matt White
 Shade White
- 20305-83 **Structure** Matt Black
 Shade Black
- 20305-84 **Structure** Matt Black
 Shade Green

Material	Structure Steel
	Shade Textile
Light Source	1 E27 LED max. 15W
Bulb incl.	No
Recom. Bulb	17463
Class	II
Cable	2m

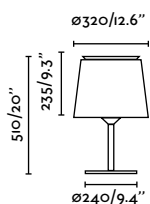

Savoy Floor

Isaac Piñeiro



- 20306-85 **Structure** Matt White
 Shade White
- 20307-86 **Structure** Matt Black
 Shade Black
- 20307-87 **Structure** Matt Black
 Shade Green

Material	Structure Steel
	Shade Textile
Light Source	1 E27 LED max. 15W
Bulb incl.	No
Recom. Bulb	17464
Class	II
Cable	2m

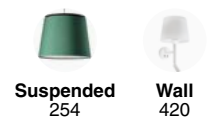
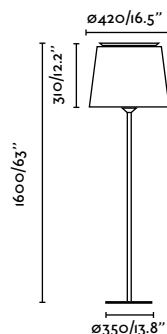



Rem Table

Àlex & Manel Llusçà



110V Check p. 30



- 29685-04 **Structure** Old Gold
 Shade White
- 29685-05 **Structure** Old Gold
 Shade Beige
- 29685-06 **Structure** Old Gold
 Shade Black

Material	Structure Steel
	Shade Textile
Light Source	1 E27 LED max. 15W
Bulb incl.	No
Recom. Bulb	17463
Class	II
Cable	1.6m

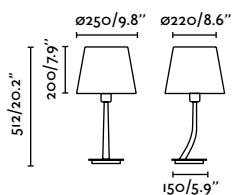

Rem Floor

Àlex & Manel Llusçà



110V Check p. 30



- 29687-07 **Structure** Old Gold
 Shade White
- 29687-08 **Structure** Old Gold
 Shade Beige
- 29687-09 **Structure** Old Gold
 Shade Black

Material	Structure Steel
	Shade Textile
Light Source	1 E27 LED max. 15W
Bulb incl.	No
Recom. Bulb	17464
Class	II
Cable	1.9m

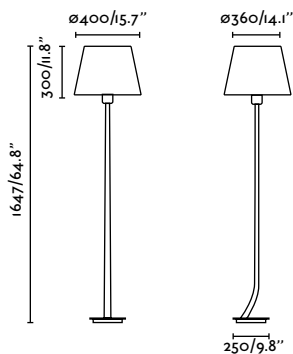

Wall
434



Artis Table
Àlex & Manel Lluscà

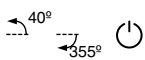

110V Check p. 30



68488 **Structure** Bronze
Shade White

Artis Floor
Àlex & Manel Lluscà

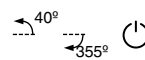

110V Check p. 30



68489 **Structure** Bronze
Shade White

Material	Structure Steel
	Shade Textile
Light Source	1 E27 LED max. 15W
Bulb incl.	No
Recom. Bulb	17463
Class	II
Cable	2.4m

Material	Structure Steel
	Shade Textile
Light Source	1 E27 LED max. 15W
Bulb incl.	No
Recom. Bulb	17463
Class	II
Cable	3.2m

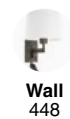
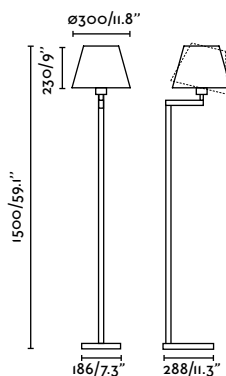
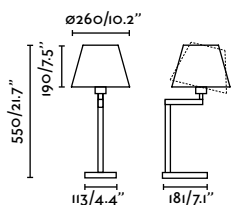

Wall
448



Nila Table



110V Check p. 30



20054 ● **Structure** Matt Black
● **Shade** Off White

Material	Structure Steel
	Shade Textile
Light Source	1 E27 LED max. 15W
Bulb incl.	No
Recom. Bulb	17463
Class	II
Cable	1.5m

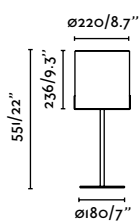

Nila Floor



ETL 110V Check p. 30



20055 ● **Structure** Matt Black
● **Shade** Off White

Material	Structure Steel
	Shade Textile
Light Source	2 E27 LED max. 15W
Bulb incl.	No
Recom. Bulb	17464
Class	II
Cable	2.3m

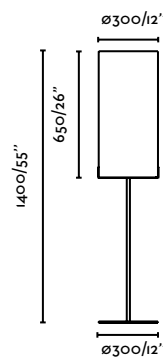

Wall
446



Vesper Table
Nahtrang



110V Check p. 30



- 29984
 - Structure Matt White
 - Shade Beige
 - Diffuser Beige
- 29985
 - Structure Brown
 - Shade Beige
 - Diffuser Beige

Material	Structure Steel
	Shade Textile
	Diffuser Textile
Light Source	2 E27 LED max. 15W
Bulb incl.	No
Recom. Bulb	17463
Class	II
Cable	1.7m

Vesper Floor
Nahtrang



110V Check p. 30



- 29979
 - Structure Brown
 - Shade Beige
 - Diffuser Beige

Material	Structure Steel
	Shade Textile
	Diffuser Textile
Light Source	2 E27 LED max. 15W
Bulb incl.	No
Recom. Bulb	17463
Class	II
Cable	3.5m

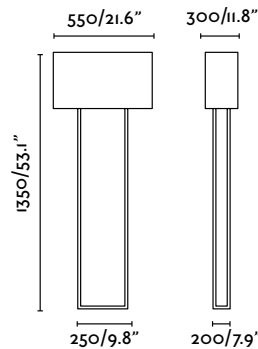
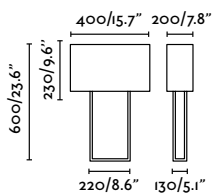
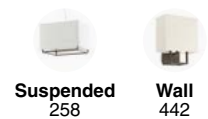

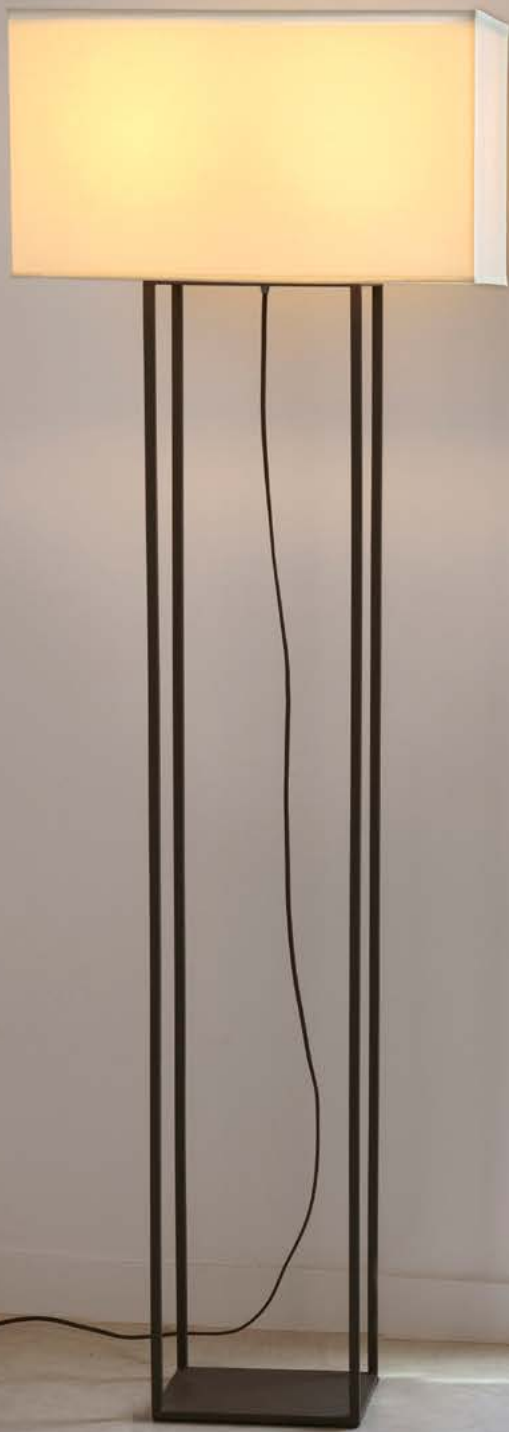

Linda Table
Estudi Ribaudí



110V Check p. 30



29311 ● Structure Matt Black
● Shade Beige

Material	Structure Steel
	Shade Textile
Light Source	1 E27 LED max. 15W
Bulb incl.	No
Recom. Bulb	17464
Class	II
Cable	2m

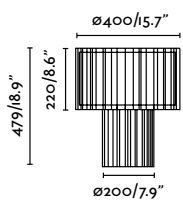

Linda Floor
Estudi Ribaudí



110V Check p. 30



29312 ● Structure Matt Black
● Shade Beige

Material	Structure Steel
	Shade Textile
Light Source	1 E27 LED max. 15W
Bulb incl.	No
Recom. Bulb	17464
Class	II
Cable	2.8m

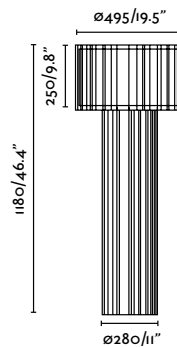

Suspended
254

Wall
504

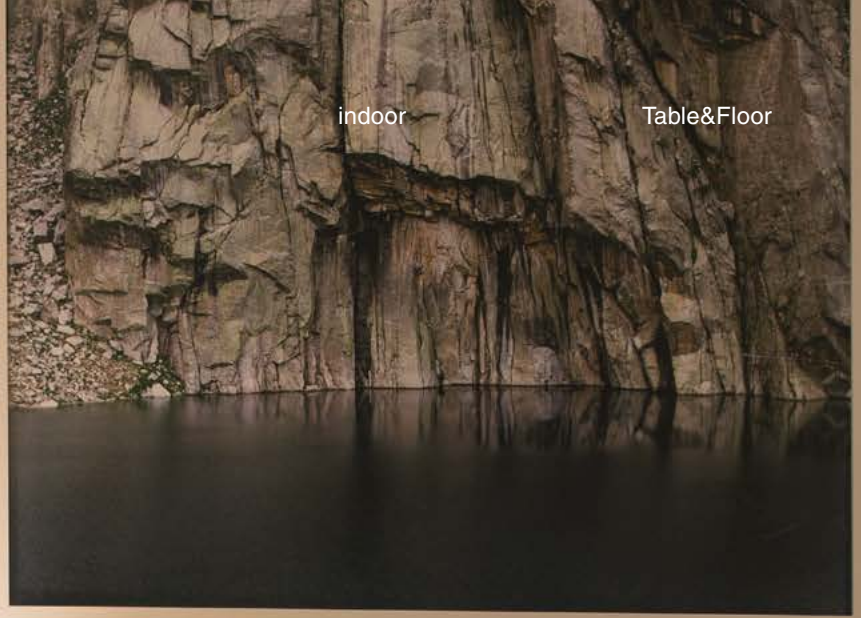

Lupe Table
Jordi Busquets



110V Check p. 30



29997 **Structure** Chrome
Shade Beige

Material	Structure Steel
	Shade Textile
Light Source	1 E27 LED max. 15W
Bulb incl.	No
Recom. Bulb	17463
Class	II
Cable	1.8m

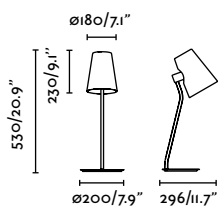

Lupe Floor
Jordi Busquets



110V Check p. 30



20034-88 **Structure** Matt Black
Shade Beige

Material	Structure Steel
	Shade Textile
Light Source	1 E27 LED max. 15W
Bulb incl.	No
Recom. Bulb	17463
Class	II
Cable	3.5m

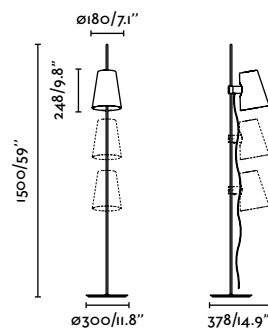

Wall
430



Adjustable Shade



Tree Table
Estudi Ribaudí



- 29866 ● **Structure** Matt Black
● **Shade** Black
- 29867 ● **Structure** Matt White
● **Shade** White

Material	Structure Steel
	Shade Textile
Light Source	1 E27 LED max. 15W
Bulb incl.	No
Recom. Bulb	17464
Class	II
Cable	1.8m

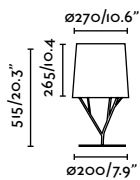

Tree Floor
Estudi Ribaudí



- 29868 ● **Structure** Matt Black
● **Shade** Black
- 29869 ● **Structure** Matt White
● **Shade** White

Material	Structure Steel
	Shade Textile
Light Source	1 E27 LED max. 15W
Bulb incl.	No
Recom. Bulb	17464
Class	II
Cable	2m

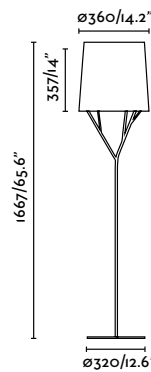

Suspended
254



Berni Table
Nahtrang



110V Check p. 30



- 29332 **Structure** Matt White
- Shade** White

- 29333 **Structure** Matt Black
- Shade** Black

Material	Structure Steel
	Shade Textile
Light Source	1 E27 LED max. 15W
Bulb incl.	No
Recom. Bulb	17463
Class	II
Cable	1.5m

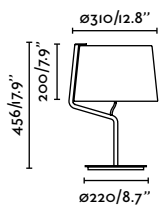

Berni Floor
Nahtrang



110V Check p. 30



- 29335 **Structure** Matt White
- Shade** White

- 29336 **Structure** Matt Black
- Shade** Black

Material	Structure Steel
	Shade Textile
Light Source	1 E27 LED max. 15W
Bulb incl.	No
Recom. Bulb	17464
Class	II
Cable	1.5m

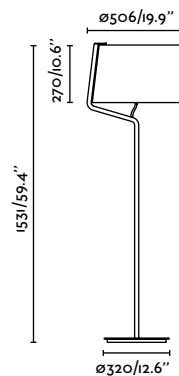

Wall
444



Volta Table
Estudi Ribaudí



110V Check p. 30



20026 ●● Structure Matt Black + Satin Nickel
● Shade Black

Material	Structure Steel
	Shade Textile
Light Source	1 E27 LED max. 15W
Bulb incl.	No
Recom. Bulb	17463
Class	II
Cable	2m

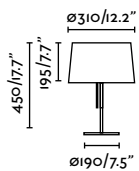

Volta Floor
Estudi Ribaudí



110V Check p. 30



20029 ●● Structure Matt White + Satin Nickel
● Shade White

20030 ●● Structure Matt Black + Satin Nickel
● Shade Black

Material	Structure Steel
	Shade Textile
Light Source	1 E27 LED max. 15W
Bulb incl.	No
Recom. Bulb	17464
Class	II
Cable	2m

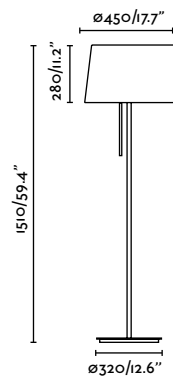



Inviting Table

Bohman And Folenius

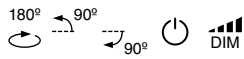

110V Check p. 30



- 57312 Structure Matt White
 Diffuser Transparent
- 57313 Structure Black
 Diffuser Transparent
- 57314 Structure Yellow
 Diffuser Transparent

Material	Structure Aluminium + Steel
	Diffuser PMMA
Power	6W
Lumen Output	586lm
Light Source	SMD LED 2700-4800K
Class	II
CRI	>80
Voltage	100V-240V/50/60Hz
Cable	1.9m

Academy Table

Nahrang



110V Check p. 30



- 28202 Structure Chrome
 Diffuser Opal

Material	Structure Aluminium + Steel
	Diffuser PMMA
Power	4W
Lumen Output	350lm
Light Source	SMD LED 3000K
Class	II
CRI	>80
Voltage	100V-240V/50/60Hz
Cable	2m



Surface
346



Clip-on
164



Wall
346

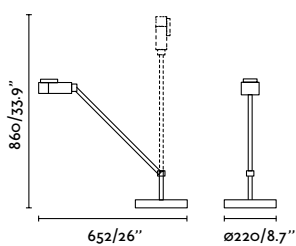

Colour temperature and intensity can be adjusted.

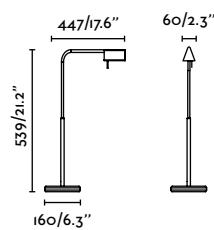



Anouk

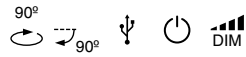

110V Check p. 30



USB Type A charger

53415 ● Structure Matt Black
● Diffuser Translucent

Anouk Induction

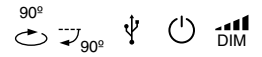

110V Check p. 30



Induction charger and USB charger, type A

53416 ● Structure Gloss White
● Diffuser Translucent

Material	Structure ABS
	Diffuser PMMA
Power	8W
Lumen Output	608lm
Light Source	SMD LED 4000K
Class	II
CRI	>80
Voltage	100V-240V/50/60Hz
Cable	1.5m

Material	Structure ABS
	Diffuser PMMA
Power	8W
Lumen Output	608lm
Light Source	SMD LED 2700-6500K
Class	II
Voltage	100V-240V/50/60Hz
Cable	1.5m

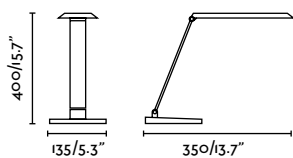

USB-A charger

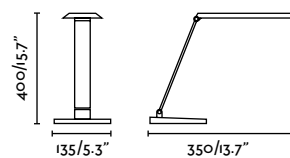

Induction charger and USB charger, type A



Otto



- 52064 **Structure** Matt Black
- Diffuser** Opal

- 52065 **Structure** Matt White
- Diffuser** Opal

Material	Structure ABS + Silicone
	Diffuser PMMA
Power	6W
Lumen Output	610lm
Light Source	SMD LED 4000K
Class	II
CRI	>80
Voltage	220V-240V/50/60Hz
Cable	1.8m

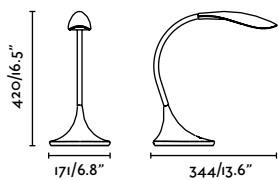

Lena



- 52057 **Structure** Gloss White
- Diffuser** Translucent

- 52058 **Structure** Gloss Black
- Diffuser** Translucent

Material	Structure Aluminium + ABS
	Diffuser Glass
Power	3W
Lumen Output	296lm
Light Source	SMD LED 4000K
Class	II
CRI	>80
Voltage	220V-240V/50/60Hz
Beam angle	70°
Cable	1.8m

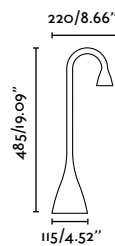

indoor

Table&Floor



Ito

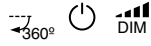

52071 ● Structure Matt Black + Satin Nickel
● Diffuser Opal

Material	Structure ABS + Aluminium
	Diffuser PMMA
Power	5W
Lumen Output	531lm
Light Source	SMD LED 3000K
Class	II
CRI	>80
Voltage	220V-240V/50/60Hz
Cable	1.8m

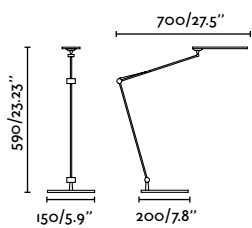

Baobab



110V Check p. 30



51908 ● Structure Matt White
51909 ● Structure Matt Black
51910 ● Structure Grey

Material	Structure Steel
Light Source	1 E14 LED max. 8W
Bulb incl.	No
Recom. Bulb	17461
Class	II
Cable	1.7m

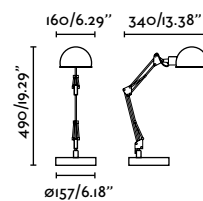



NEW



Tider Cable Management Accessory

20546

● Textured Black

Material

Structure TPU

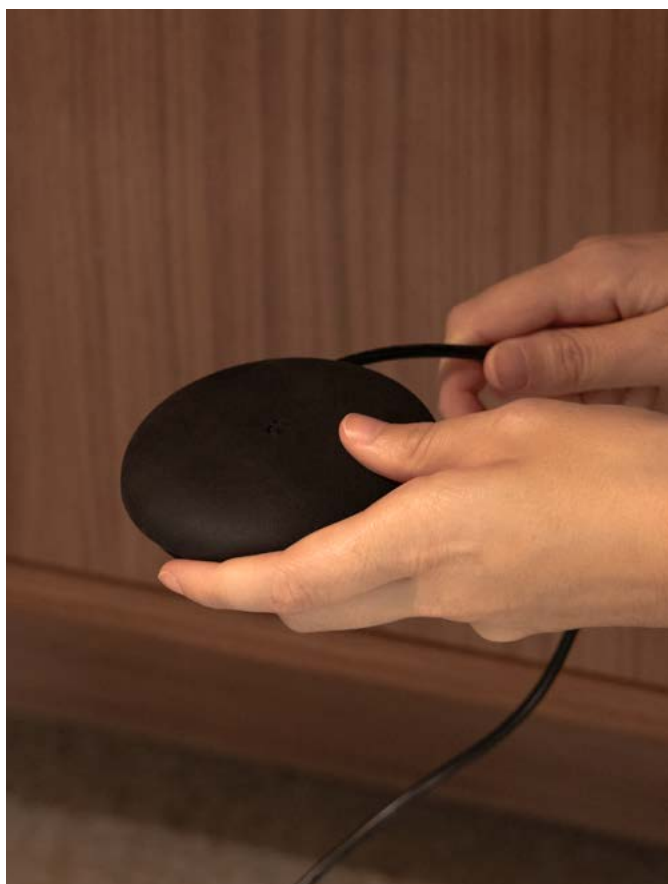
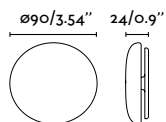

Cable management accessory designed to keep your environment cleaner, more organized, and safer. It features an adhesive backing that allows it to be firmly fixed to vertical or horizontal surfaces, preventing tripping and slipping hazards.

Made of high-strength PP, it withstands impacts and foot traffic without deforming. The soft section, made of TPE, provides a pleasant touch and a more secure grip.

*Check the specifications of each model to verify compatibility.

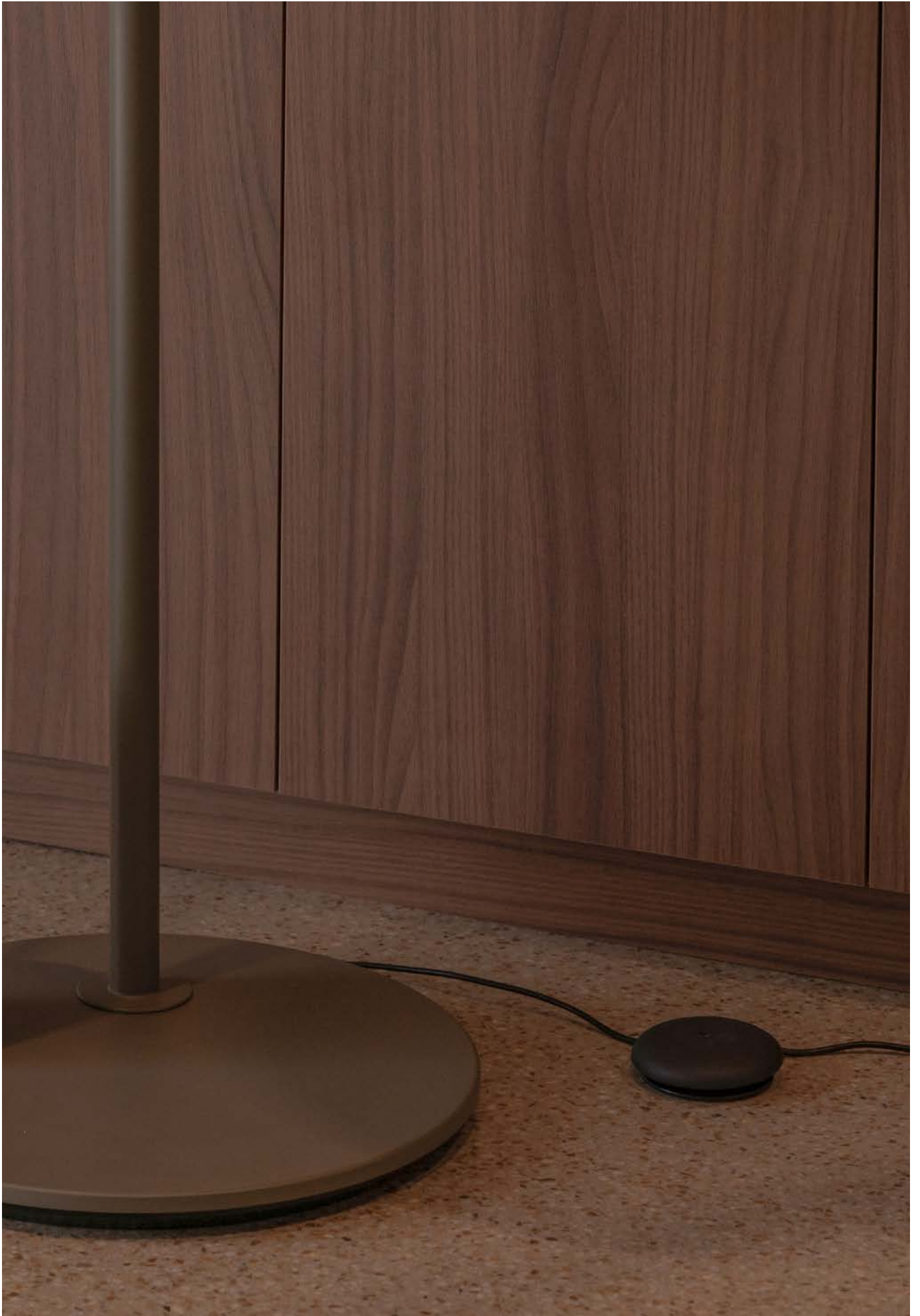



INDOOR

LIGHTING



CLIP-ON



Bela
Faro Lab



110V Check p. 30



56100	● Structure Gloss Black
56101	● Structure Gloss White
56102	● Structure Gloss Blue
56103	● Structure Gloss Red

Material	Structure Steel
	Shade Steel
Light Source	1 E27 LED G45 max. 15W
Bulb incl.	No
Recom. Bulb	17462
Class	II
Cable	2.7m

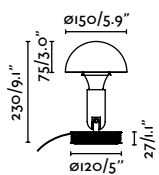

Tabletop ring
accessory



Inviting
Bohman And Folenius

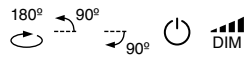

110V Check p. 30



- 57315 **Structure** Matt White
 Diffuser Transparent

- 57316 **Structure** Matt Black
 Diffuser Transparent

- 57317 **Structure** Yellow
 Diffuser Transparent



Material	Structure Aluminium Diffuser PMMA
Power	6W
Lumen Output	586lm
Light Source	SMD LED 2700-4800K
Class	II
CRI	>80
Voltage	100V-240V/50/60Hz
Cable	1.9m



reddot award 2019
winner

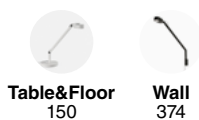
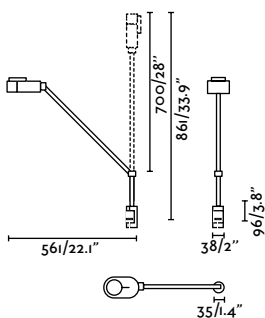

Colour temperature
and intensity can
be adjusted.

indoor

Clip-on



Pepper

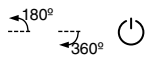

110V Check p. 30



64169 ● Structure Matt Black +
● Matt White

Studio Clip Nahtrang



110V Check p. 30



51133 ● Structure Matt Black
51135 ● Structure Gloss White

Lena Clip



52059 ● Structure Matt White
52061 ● Structure Matt Black

Material	Structure Steel
Light Source	1 E27 LED max. 15W
Bulb incl.	No
Recom. Bulb	17462
Class	II
Cable	1.7m

Material	Structure Aluminium + ABS
Light Source	1 E14 LED max. 8W
Bulb incl.	No
Recom. Bulb	17461
Class	II
Cable	1.6m

Material	Structure PC + Aluminium
Power	3W
Lumen Output	296lm
Light Source	SMD LED 4000K
Class	II
CRI	>80
Voltage	220V-240V/50/60Hz
Beam angle	30°
Cable	1.8m

Studio Accessory

51129 ● Black

Material	Structure Steel
-----------------	-----------------



Suspended
206



Wall
338



Table&Floor
96



Table&Floor
154

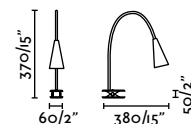
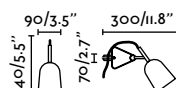
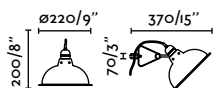

indoor

Clip-on





INDOOR

LIGHTING

SUSPENDED



indoor

Suspended



LUMINA

Carrasquet

171





Lumina transforms light into visible matter, creating atmospheres rich in warmth and character. A piece defined by both technical precision and emotional depth, with a pure form and a discreet yet unmistakable presence.



The elements can be linked, clustered or suspended, allowing for linear, angular or free-hanging configurations that flexibly adapt to each project. The result is a piece of both technical and emotional character, with a formal purity and a discreet yet unmistakable presence.

Each module can be installed independently or combined into more complex structures—up to three per driver. The elements can be linked, clustered or suspended, enabling linear, angular or free-hanging configurations that adapt flexibly to each project. Every composition blends naturally into the architecture, casting a balanced light that enhances usability and deepens the spatial experience.



The system is built around a striated glass module with a star-shaped profile—an intricate geometry that amplifies reflections and softens light diffusion, unveiling a warm texture that fosters a sense of wellbeing.





Lumina 64602-111

A collection of pendant luminaires that goes beyond function to become a tool for lighting architecture. Its language is understated and precise; its presence, calm and essential.

Lumina Carrasquet

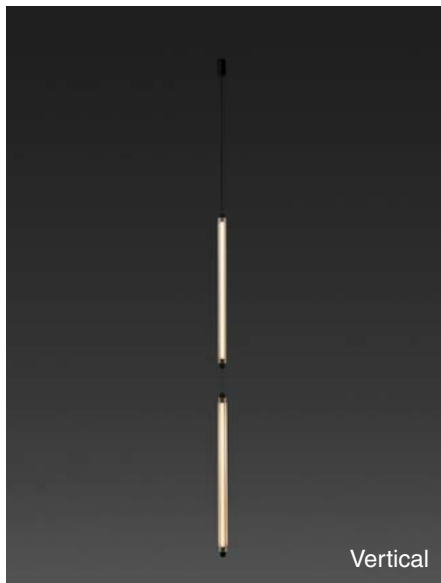

Serie	Color	Temperature	Installation	Glass	Control
6460	600 1L Vertical	2 Black	-1 2200K	1 Transparent	D DALI
6462	600 2L Vertical	-2 2700K	3 Recessed Canopy		ON/OFF
6464	600 3L Vertical		* *Compatible with Neso Slim. Check our Architectural catalogue.		
6466	900 1L Vertical				
6461	600 1L Horizontal				
6467	900 1L Horizontal				
6468	1200 1L Horizontal				
6463	600 2L Swag				
6465	600 3L Swag				

Example **64602-111D** — Lumina 600 1L Vertical Black 2200K Surface Canopy Transparent DALI

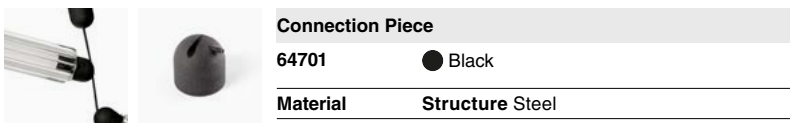

VERTICAL

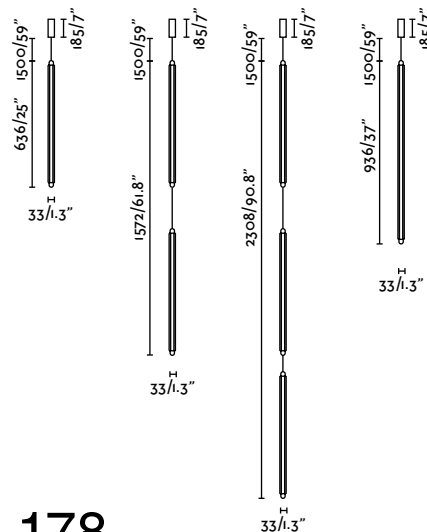

HORIZONTAL

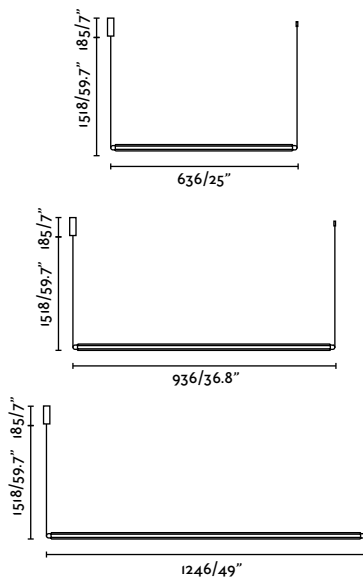

SWAG

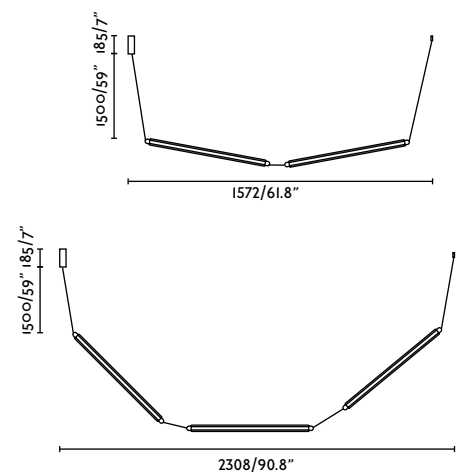



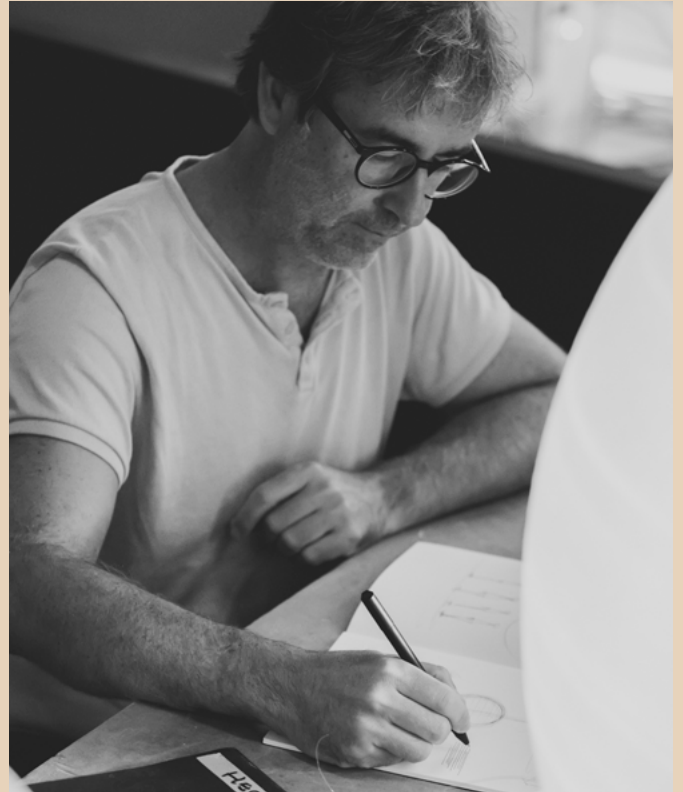

Tierra and Aire arose from a concern about or interest in two concepts. First, an intention to democratise 3D printing on a large scale by integrating it as another industrial process in light manufacturing. Second, and most importantly, an interest in producing increasingly sustainable products and contributing to circularity. The project is something of a rallying cry encouraging us to consider our relationship with the planet in response to the current climate crisis. Nature does not generate waste: we must learn from it and move towards a more circular and sustainable product.

indoor

Suspended

Tierra y Aire

Designed by Héctor Serrano



Tierra 470
Héctor Serrano



20400 ● Structure Black
● Shade Beige

Tierra 500
Héctor Serrano



20401 ● Structure Black
● Shade Beige

Tierra 520
Héctor Serrano



20402 ● Structure Black
● Shade Beige

Material	Structure Steel Shade PLA + Pine Cellulose
Light Source	1 E27 LED G120 max. 20W
Bulb incl.	No
Recom. Bulb	17478
Class	II
Cable	2m

Material	Structure Steel Shade PLA + Pine Cellulose
Light Source	1 E27 LED G120 max. 20W
Bulb incl.	No
Recom. Bulb	17478
Class	II
Cable	2m

Material	Structure Steel Shade PLA + Pine Cellulose
Light Source	1 E27 LED G120 max. 20W
Bulb incl.	No
Recom. Bulb	17478
Class	II
Cable	2m

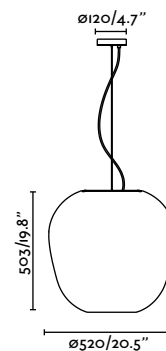
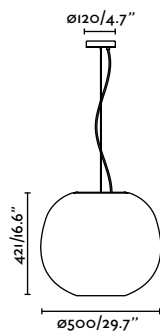
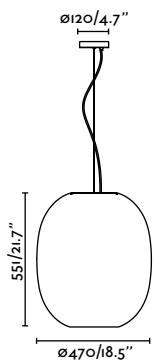

indoor

Suspended



Made from plant-based bioplastic, its forms evoke bee nests, merging digital craft and nature.



indoor

Suspended



Aire 450
Héctor Serrano



20406 ● Structure White
● Shade Translucent

Aire 650
Héctor Serrano



20407 ● Structure White
● Shade Translucent

Aire 850
Héctor Serrano



20408 ● Structure White
● Shade Translucent

Material	Structure Steel Shade Recycled PETG
Light Source	1 E27 LED max. 15W
Bulb incl.	No
Recom. Bulb	17463
Class	II
Cable	3m

Material	Structure Steel Shade Recycled PETG
Light Source	1 E27 LED G120 max. 20W
Bulb incl.	No
Recom. Bulb	17478
Class	II
Cable	3m

Material	Structure Steel Shade Recycled PETG
Light Source	1 E27 LED G120 max. 20W
Bulb incl.	No
Recom. Bulb	17478
Class	II
Cable	3m

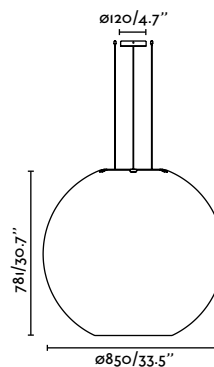
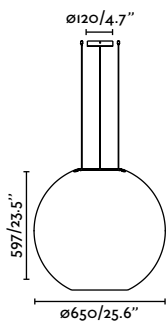
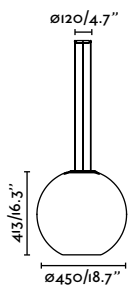

indoor

Suspended

Its crystalline texture and appearance magically diffuse light through the shade of the lamp.

Cata Pendant
Marina Milá

incl.

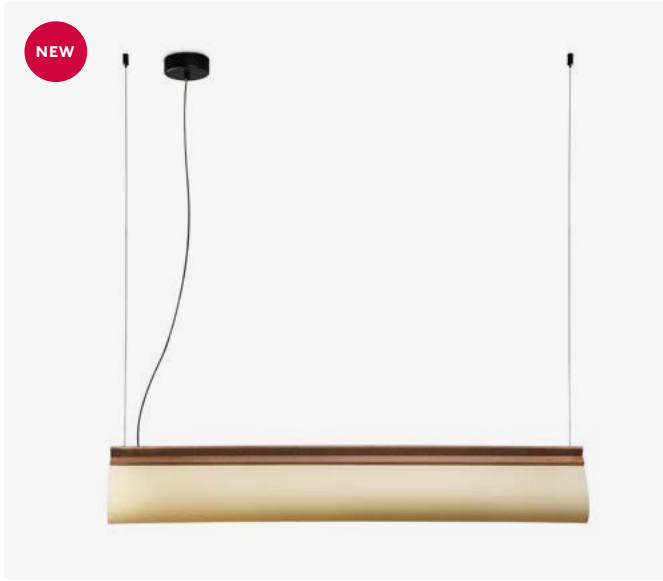

110V Check p. 30



20329 **Structure Wood**
 Shade Beige



Material	Structure Walnut Wood
	Shade Papyrus
Power	15W
Lumen Output	680lm
Light Source	SMD LED 2700K
Class	II
CRI	>80
Voltage	100V-240V/50/60Hz
Beam angle	120°
Cable	2m

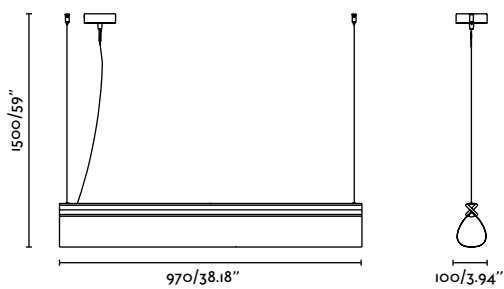

Table&Floor 42 **Surface** 408



indoor

Suspended



The pendant version of Cata includes a cable and plug, offering two installation options: the cable can exit from either the center or one side of the lamp. This flexibility allows for optimized wiring and a clean, customized installation tailored to the design of the space.



Dome 29917

indoor

Suspended

Dome

Designed by Faro Lab

Dome is a complete and diverse collection. Not only is it available in table, floor, and pendant versions, but its shade also comes in two different sizes. Perfect for those looking for visual coherence in both contract and residential spaces.

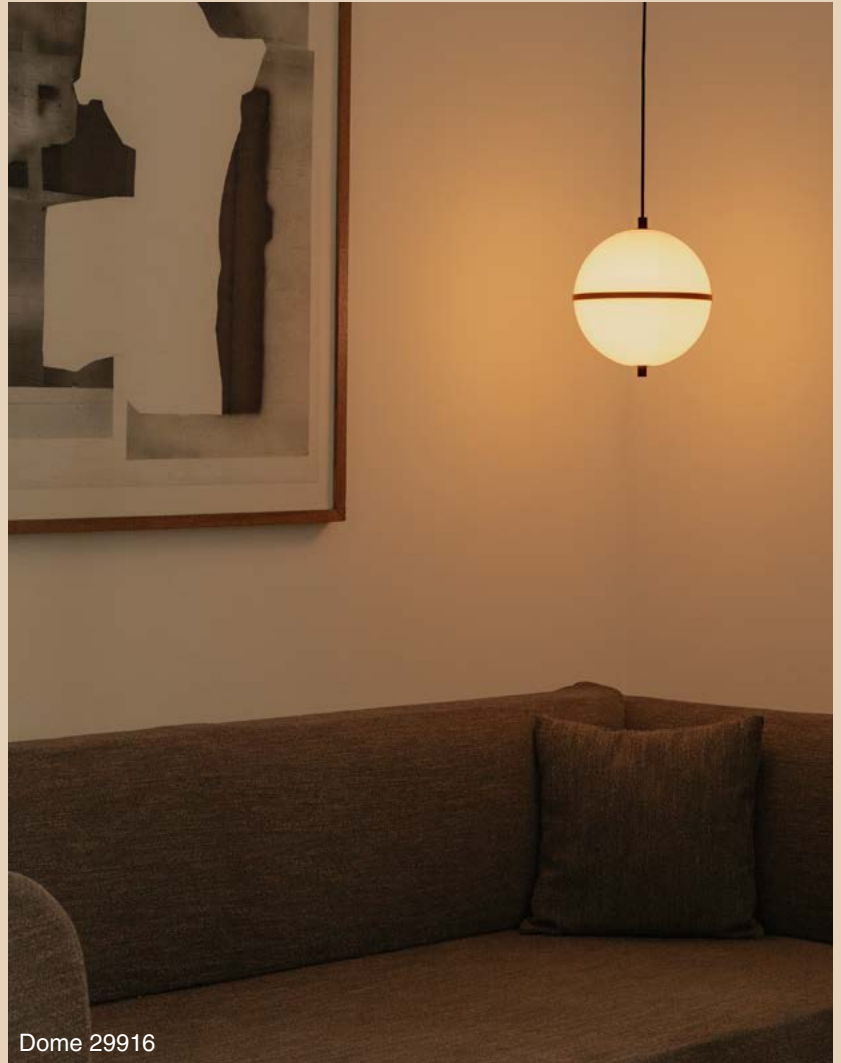

Dome 29916



Dome 29918

Dome Pendant S

Faro Lab

110V Check p. 30

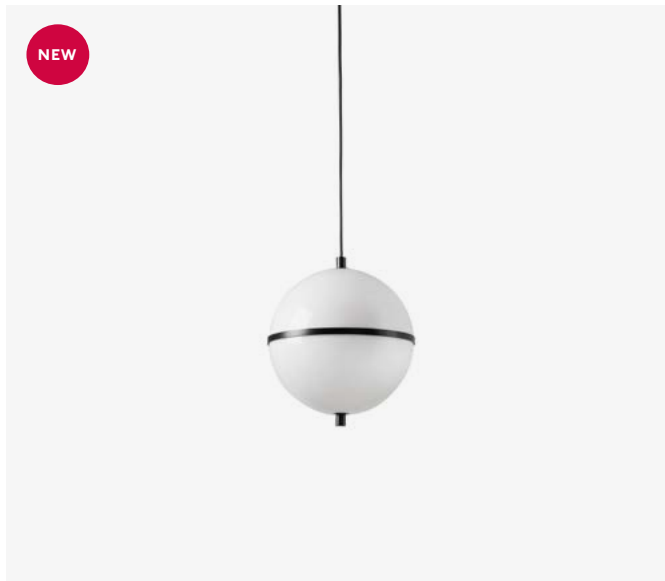

29916

● Structure Satin Black
● Shade Gloss White

Dome Pendant M

Faro Lab

110V Check p. 30



29917

● Structure Satin Black
● Shade Gloss White

Material	Structure Steel
	Shade PMMA
Light Source	1 E27 LED G45 max. 15W
Bulb incl.	No
Recom. Bulb	17524
Class	II
Cable	2m

Material	Structure Steel
	Shade PMMA
Light Source	1 E27 LED G95 max. 20W
Bulb incl.	No
Recom. Bulb	17542
Class	II
Cable	2m

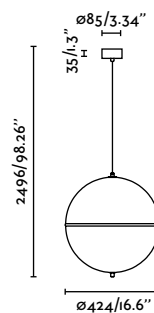
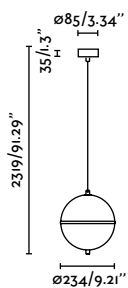

indoor

Suspended



Dome draws inspiration from the refined aesthetics of the 1970s, reimagined with modern materials and finishes. Its opal dome diffuses a warm, even light that transforms the space into a serene, timeless, and welcoming atmosphere.

Dome 29917

Dome Pendant M Plug
Faro Lab



29918 ● **Structure** Satin Black
● **Shade** Gloss White

Material	Structure Steel
	Shade PMMA
Light Source	1 E27 LED G95 max. 20W
Bulb incl.	No
Recom. Bulb	17542
Class	II
Cable	3.4m

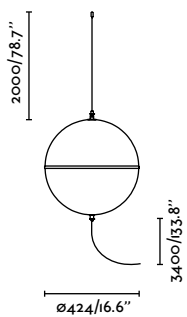
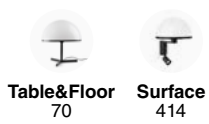

indoor

Suspended



Isabelle Pendant 310

Héctor Serrano



28300 ● Structure Matt White
● Shade Opal

Isabelle Pendant 400

Héctor Serrano



28301 ● Structure Matt White
● Shade Opal

Isabelle Pendant 500

Héctor Serrano



28302 ● Structure Matt White
● Shade Opal

Material	Structure Steel
	Shade Glass
Light Source	1 E27 LED max. 15W
Bulb incl.	No
Recom. Bulb	17528
Class	II
Cable	2m

Material	Structure Steel
	Shade Glass
Light Source	1 E27 LED max. 15W
Bulb incl.	No
Recom. Bulb	17528
Class	II
Cable	2m

Material	Structure Steel
	Shade Glass
Light Source	1 E27 LED max. 15W
Bulb incl.	No
Recom. Bulb	17528
Class	II
Cable	2m



Surface
512

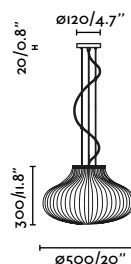
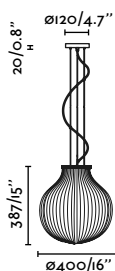
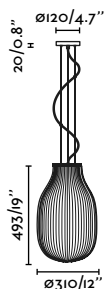



Three models that can be implemented individually or together depending on architectural needs.

Tatawin Glass S

Adolfo Abejón



20339-116 ● **Structure** Satin Black
● **Shade** Opal

20339-117 ● **Structure** Satin Black
● **Shade** Gloss Black

Material	Structure Steel
	Shade Glass
Light Source	1 E27 LED G45 max. 15W
Bulb incl.	No
Recom. Bulb	17462
Class	II
Cable	2m

Tatawin Metal S

Adolfo Abejón



20339-140 ● **Structure** Satin Black
● **Shade** Gloss White

20339-141 ● **Structure** Satin Black
● **Shade** Gloss Black

20339-142 ● **Structure** Satin Black
● **Shade** Gloss Grayish Blue

20339-143 ● **Structure** Satin Black
● **Shade** Gloss Reddish Orange

20339-144 ● **Structure** Satin Black
● **Shade** Gloss Green

Material	Structure Steel
	Shade Steel
Light Source	1 E27 LED G45 max. 15W
Bulb incl.	No
Recom. Bulb	17462
Class	II
Cable	2m

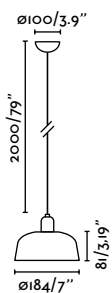

indoor

Suspended



The shape of the lampshade is reminiscent of the upper part of the characteristic houses of Tataouine, a city located in the south-east of Tunisia.

Tatawin Glass M

Adolfo Abejón



20339-119 ● **Structure** Satin Black
● **Shade** Opal

20339-120 ● **Structure** Satin Black
● **Shade** Gloss Black

Material	Structure Steel Shade Glass
Light Source	1 E27 LED max. 15W
Bulb incl.	No
Recom. Bulb	17463
Class	II
Cable	2m

Tatawin Metal M

Adolfo Abejón



20339-145 ● **Structure** Satin Black
● **Shade** Gloss White

20339-146 ● **Structure** Satin Black
● **Shade** Gloss Black

20339-147 ● **Structure** Satin Black
● **Shade** Gloss Grayish Blue

20339-148 ● **Structure** Satin Black
● **Shade** Gloss Reddish Orange

20339-149 ● **Structure** Satin Black
● **Shade** Gloss Green

Material	Structure Steel Shade Steel
Light Source	1 E27 LED max. 15W
Bulb incl.	No
Recom. Bulb	17463
Class	II
Cable	2m

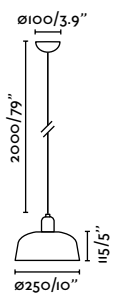

indoor

Suspended



Tatawin Glass S Lineal

Adolfo Abejón



20338-116 ● **Structure** Satin Black
● **Shade** Opal

20338-117 ● **Structure** Satin Black
● **Shade** Gloss Black

Material	Structure Steel Shade Glass
Light Source	3 E27 LED G45 max. 15W
Bulb incl.	No
Recom. Bulb	17462
Class	II
Cable	2m

Tatawin Metal S Lineal

Adolfo Abejón

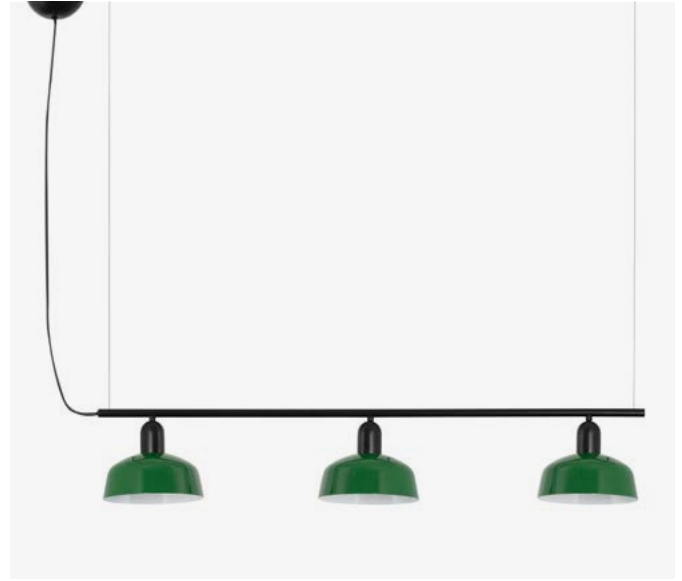

20338-140 ● **Structure** Satin Black
● **Shade** Gloss White

20338-141 ● **Structure** Satin Black
● **Shade** Gloss Black

20338-142 ● **Structure** Satin Black
● **Shade** Gloss Grayish Blue

20338-143 ● **Structure** Satin Black
● **Shade** Gloss Reddish Orange

20338-144 ● **Structure** Satin Black
● **Shade** Gloss Green

Material	Structure Steel Shade Steel
Light Source	3 E27 LED G45 max. 15W
Bulb incl.	No
Recom. Bulb	17462
Class	II
Cable	2m

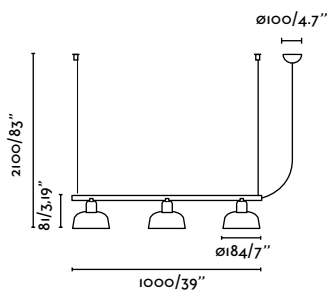

indoor

Suspended



Tatawin Glass M Lineal

Adolfo Abejón



20338-119 ● **Structure** Satin Black
● **Shade** Opal

20338-120 ● **Structure** Satin Black
● **Shade** Gloss Black

Material	Structure Steel
	Shade Glass
Light Source	3 E27 LED max. 15W
Bulb incl.	No
Recom. Bulb	17463
Class	II
Cable	2m

Tatawin Metal M Lineal

Adolfo Abejón

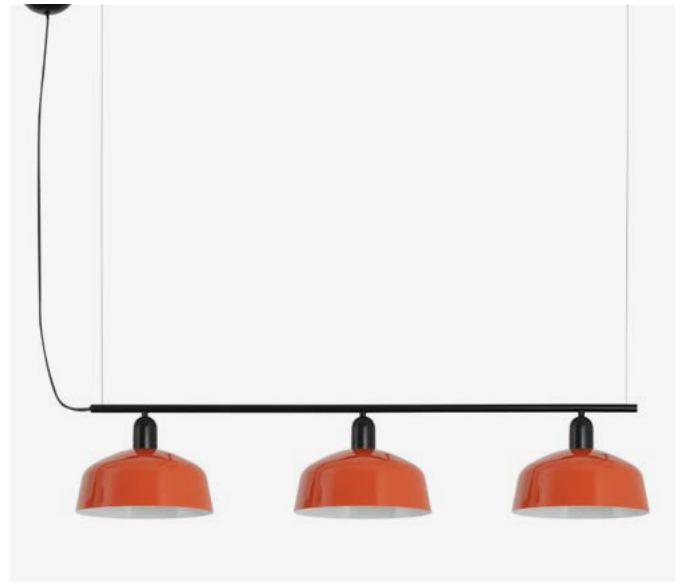

20338-145 ● **Structure** Satin Black
● **Shade** Gloss White

20338-146 ● **Structure** Satin Black
● **Shade** Gloss Black

20338-147 ● **Structure** Satin Black
● **Shade** Gloss Grayish Blue

20338-148 ● **Structure** Satin Black
● **Shade** Gloss Reddish Orange

20338-149 ● **Structure** Satin Black
● **Shade** Gloss Green

Material	Structure Steel
	Shade Steel
Light Source	3 E27 LED max. 15W
Bulb incl.	No
Recom. Bulb	17463
Class	II
Cable	2m

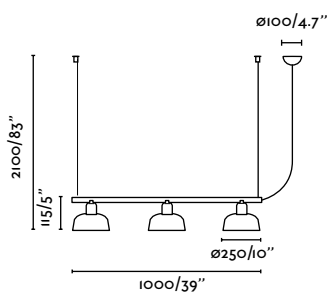
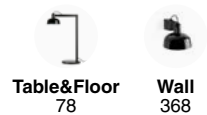

indoor

Suspended



Studio 110
Nahrang

110V Check p. 30



- 28260 ● Structure Matt Black
● Shade Matt Black
- 28261 ● Structure Matt Black
● Shade Matt White
- 28262 ● Structure Matt Black
● Shade Matt Green
- 28277 ● Structure Matt Black
● Shade Matt Blue
- 28278 ● Structure Matt Black
● Shade Matt Pink

Material	Structure Steel Shade Steel
Light Source	1 E14 LED max. 8W
Bulb incl.	No
Recom. Bulb	17461
Class	II
Cable	2m

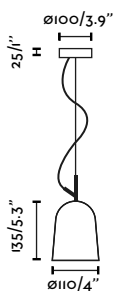

Studio 160
Nahrang

110V Check p. 30



- 28263 ● Structure Matt Black
● Shade Matt Black
- 28264 ● Structure Matt Black
● Shade Matt White
- 28265 ● Structure Matt Black
● Shade Matt Green
- 28279 ● Structure Matt Black
● Shade Matt Blue
- 28280 ● Structure Matt Black
● Shade Matt Pink

Material	Structure Steel Shade Steel
Light Source	1 E27 LED max. 15W
Bulb incl.	No
Recom. Bulb	17463
Class	II
Cable	2m

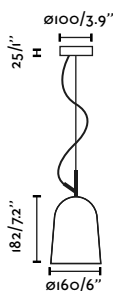

Studio 290
Nahrang

ETL 110V Check p. 30



- 28283 ● Structure Matt Black
● Shade Matt Black
- 28284 ● Structure Matt Black
● Shade Matt White
- 28285 ● Structure Matt Black
● Shade Matt Green
- 28286 ● Structure Matt Black
● Shade Matt Blue
- 28287 ● Structure Matt Black
● Shade Matt Pink

Material	Structure Steel Shade Steel
Light Source	1 E27 LED G95 max. 15W
Bulb incl.	No
Recom. Bulb	17464
Class	II
Cable	2m

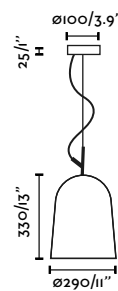

indoor

Suspended



Studio Lineal

Nahtrang

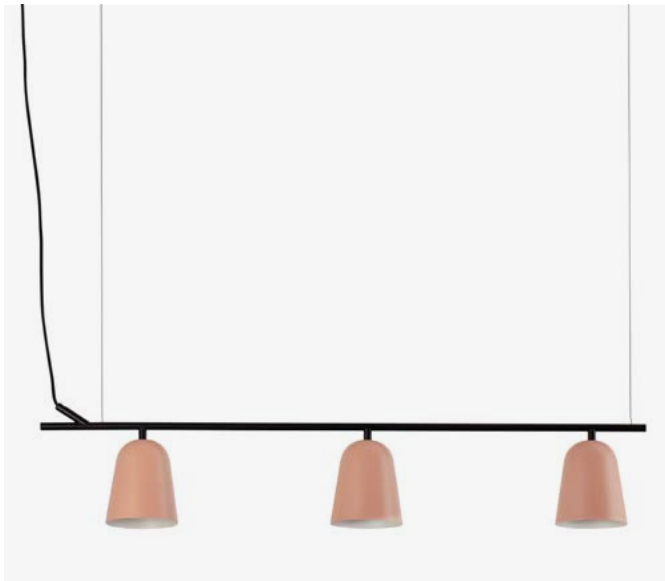

28266	● Structure Matt Black ● Shade Matt Black
28267	● Structure Matt Black ● Shade Matt White
28268	● Structure Matt Black ● Shade Matt Green
28281	● Structure Matt Black ● Shade Matt Blue
28282	● Structure Matt Black ● Shade Matt Pink

Material	Structure Steel
	Shade Steel
Light Source	3 E14 LED max. 8W
Bulb incl.	No
Recom. Bulb	17461
Class	II
Cable	2m

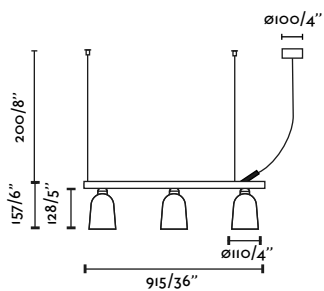

indoor

Suspended



Vico 600
Faro Lab

incl. DIM TRIAC

110V Check p. 30



- 61101 Surface ● Structure Matt Black
● Diffuser Opal
- 61105 Recessed ● Structure Matt Black
● Diffuser Opal



Surface

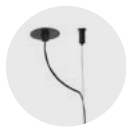

Recessed

Material	Structure Aluminium
	Diffuser PC
Power	15W
Lumen Output	925lm
Light Source	SMD LED 2700K
Class	II
CRI	≥90
Voltage	220V-240V/50/60Hz
Beam angle	110°
Cable	2m



Vico Accessory joint kit

61117 ● Matt Black

Material Structure Steel

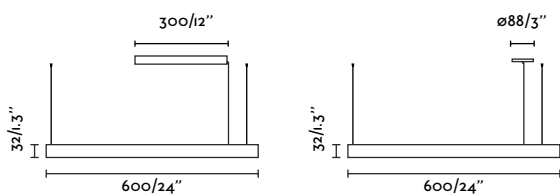

Vico 1150
Faro Lab

incl. DIM TRIAC

110V Check p. 30

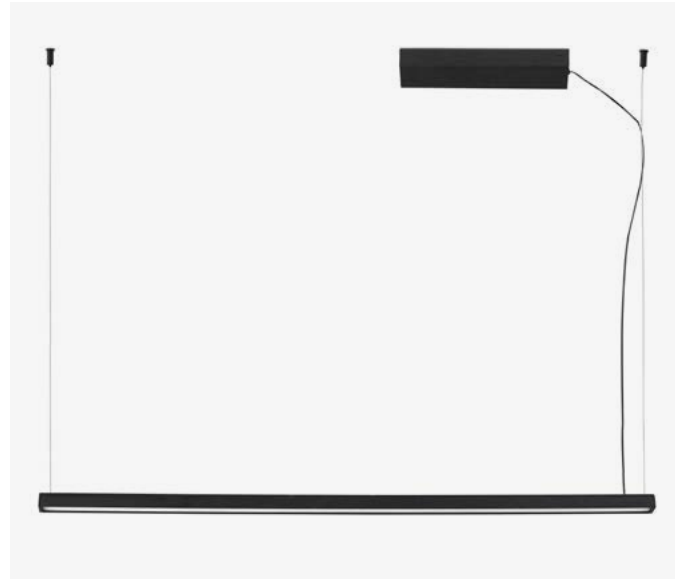

- 61103 Surface ● Structure Matt Black
● Diffuser Opal
- 61104 Recessed ● Structure Matt Black
● Diffuser Opal



Surface

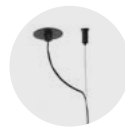

Recessed

Material	Structure Aluminium
	Diffuser PC
Power	30W
Lumen Output	1703lm
Light Source	SMD LED 2700K
Class	II
CRI	≥90
Voltage	220V-240V/50/60Hz
Beam angle	110°
Cable	2m

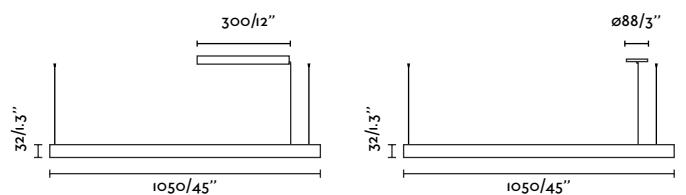

*More dimmable options under request

indoor

Suspended



Venice 160
Adolfo Abejón



64255	● Structure Black ● Shade Gloss White
64256	● Structure Black ● Shade Gloss Black
64258	● Structure Black Shade White & Gloss Black
64257	● Structure Black ● Shade Gloss Pink
64259	● Structure Black ● Shade Gloss Blue

Material	Structure Steel Shade Ceramic
Light Source	1 E27 LED max. 15W
Bulb incl.	No
Recom. Bulb	17463
Class	II
Cable	2m

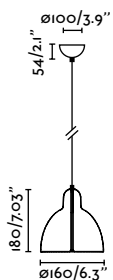

Venice 200
Adolfo Abejón



64255-124	● Structure Black ● Shade Gloss White
64255-125	● Structure Black ● Shade Gloss Black
64255-126	● Structure Black ● Shade Gloss Pink
64255-128	● Structure Black ● Shade Gloss Blue
64255-127	● Structure Black Shade White & Gloss Black

Material	Structure Steel Shade Ceramic
Light Source	1 E27 LED max. 15W
Bulb incl.	No
Recom. Bulb	17463
Class	II
Cable	2m

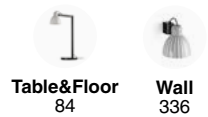
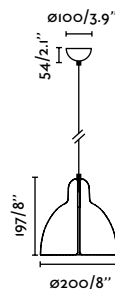

*Compatible with track system on page 287

indoor

Suspended

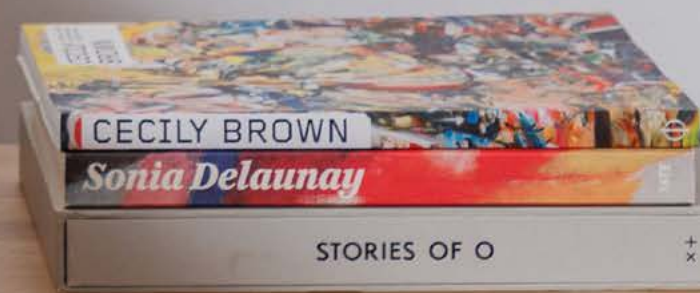

Whizz Pendant

Christoph Friedrich Wagner



- 20160 **Structure** Black + Satin Gold
- 20161 **Structure** Satin Gold + Black
- 20169 **Structure** Blue + White

Material	Structure Steel
Light Source	1 E27 LED max. 15W
Bulb incl.	No
Recom. Bulb	17496
Class	II
Cable	1.5m

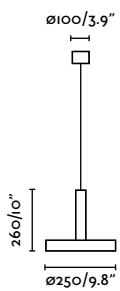

Whizz Pendant Floor

Christoph Friedrich Wagner



- 20166-95 **Structure** Black
- 20166-95 **Shade** Black + Satin Gold
- 20166-96 **Structure** Black
- 20166-96 **Shade** Satin Gold + Black

Material	Structure Steel
	Shade Steel
Light Source	1 E27 LED max. 15W
Bulb incl.	No
Recom. Bulb	17496
Class	II
Cable	3.4m

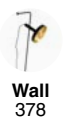
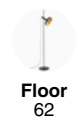
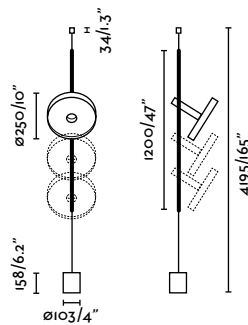

*Compatible with track system on page 287

indoor

Suspended



Kombo 120
Nutcreatives



68591-1L ● Structure Matt Black
● Shade Grey

68592-1L ● Structure Matt Black
● Shade Beige

Kombo 200
Nutcreatives



68593-1L ● Structure Matt Black
● Shade Grey

68594-1L ● Structure Matt Black
● Shade Beige

Kombo 400
Nutcreatives



68595-1L ● Structure Matt Black
● Shade Grey

68596-1L ● Structure Matt Black
● Shade Beige

68597-1L ● Structure Matt Black
● Shade Terracotta

Material	Structure Steel
	Shade Steel
Light Source	1 E27 LED A60 max. 15W
Bulb incl.	No
Recom. Bulb	17463
Class	II
Cable	1.5m

Material	Structure Steel
	Shade Steel
Light Source	1 E27 LED max. 15W
Bulb incl.	No
Recom. Bulb	17463
Class	II
Cable	1.5m

Material	Structure Steel
	Shade Steel
Light Source	1 E27 LED max. 15W
Bulb incl.	No
Recom. Bulb	17463
Class	II
Cable	1.5m

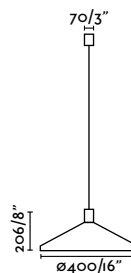
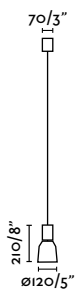

*Compatible with track system on page 287

indoor

Suspended



Kombo 68591-1L

217

Nina



- 22023 ● **Structure** Matt Black
● **Diffuser** Transparent
- 22024 ● **Structure** Matt White
● **Diffuser** Transparent
- 22025 ● **Structure** Satin Gold
● **Diffuser** Transparent

Material	Structure Aluminium Diffuser PMMA
Power	4W
Lumen Output	108lm
Light Source	SMD LED 2700K
Class	II
CRI	90
Voltage	220V-240V/50/60Hz
Beam angle	38°
Cable	1.5m

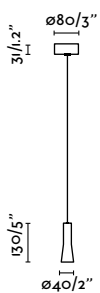

*Compatible with Neso Slim. Check our Architectural catalogue.

218

Plat

110V Check p. 30



- 68145 ● **Structure** Matt Black
- 68146 ● **Structure** Matt White

Material	Structure Steel
Light Source	1 E27 LED max. 15W
Bulb incl.	No
Recom. Bulb	17271
Class	II
Cable	1.5m



*Compatible with track system on page 287

indoor

Suspended



Side 200 Pendant
Àlex & Manel Llusçà

110V Check p. 30



62139 ● Structure Matt Black +
● Satin Copper
● Diffuser Opal

Material	Structure Steel
	Diffuser Glass
Light Source	1 G9 LED max. 6W
Bulb incl.	No
Recom. Bulb	17443
Class	II
Cable	1.5m

Pluma
Nahrang

incl.



64172 ● Structure Matt Black +
● Matt Gold
● Diffuser Opal

Material	Structure Aluminium
	Diffuser PMMA
Power	6W
Lumen Output	161lm
Light Source	SMD LED 3000K
Class	II
CRI	>80
Voltage	220V-240V/50/60Hz
Cable	1.5m

Marisol

incl. DIM TRIAC



60012 ● Structure Matt White
● Diffuser Opal
60013 ● Structure Matt Black
● Diffuser Opal

Material	Structure Steel
	Diffuser Glass
Power	14,5W
Lumen Output	887lm
Light Source	SMD LED 2700K
Class	I
CRI	90
Voltage	220V-240V/50/60Hz
Cable	1.5m



Ceiling
316

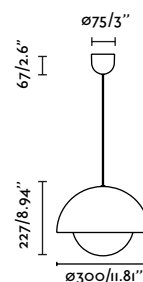
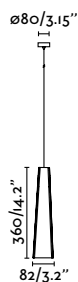
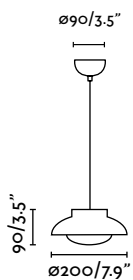

*Compatible with track system on page 287

indoor

Suspended



Mine Glass Pendant

Nahrang

110V Check p. 30



28375 ● Structure Matt White
● Diffuser Opal

28376 ● Structure Dark Grey
● Diffuser Opal

Material Structure Aluminium + Beech wood

Diffuser Glass

Light Source 1 E27 LED max. 15W

Bulb incl. No

Recom. Bulb 17463

Class II

Cable 4m

Mine PC Pendant

Nahrang

110V Check p. 30



28209 ● Structure Matt White
● Diffuser Opal

28210 ● Structure Dark Grey
● Diffuser Opal

Material Structure Aluminium + Beech wood

Diffuser PC

Light Source 1 E27 LED max. 15W

Bulb incl. No

Recom. Bulb 17463

Class II

Cable 4m

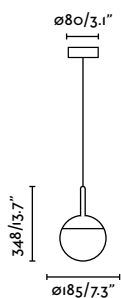

Table
52

*Compatible with track system on page 287

indoor

Suspended



Le Vita Pendant
Nahtrang



110V Check p. 30



- 29691 ● **Structure** Gloss Gold
● **Diffuser** Opal
- 29696 ● **Structure** Matt Black
● **Diffuser** Opal

Material	Structure Steel
	Diffuser Glass
Power	14W
Lumen Output	1392lm
Light Source	SMD LED 2700K
Class	I
CRI	>80
Voltage	220V-240V/50/60Hz
Cable	1.5m

Le Vita Pendant Floor
Nahtrang



- 29694 ● **Structure** Gloss Gold
● **Diffuser** Opal
- 29699 ● **Structure** Matt Black
● **Diffuser** Opal

Material	Structure Steel
	Diffuser Glass
Power	7W
Lumen Output	694lm
Light Source	SMD LED 2700K
Class	II
CRI	>80
Voltage	220V-240V/50/60Hz
Cable	1.5m

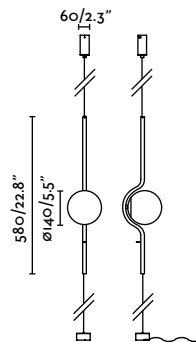
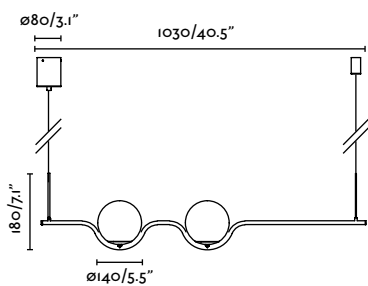
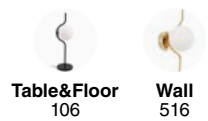

*Max. ceiling height 3mts.

indoor

Suspended



Marlin

110V Check p. 30



64133  Structure Old Gold
 Shade Matt Black

Material	Structure Steel
	Shade Steel
Light Source	1 E27 LED max. 15W
Bulb incl.	No
Recom. Bulb	17428
Class	I
Cable	1.5m

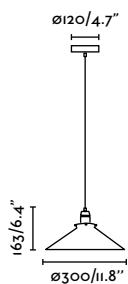

Retro Pendant Àlex & Manel Lluscà

110V Check p. 30



20050  Structure Matt Black
+ Chrome

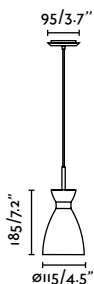

Material	Structure Steel
Light Source	1 E14 LED max. 8W
Bulb incl.	No
Recom. Bulb	17461
Class	I
Cable	1.6m



Claire

110V Check p. 30



62802  Structure Gloss Black
 Shade Gloss Black

62803  Structure Gloss Black
 Shade Gloss Green

Material	Structure Steel
	Shade Steel
Light Source	1 E27 LED max. 15W
Bulb incl.	No
Recom. Bulb	17426
Class	I
Cable	1.4m

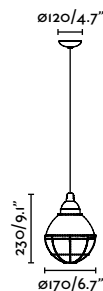

Wall
360

*Compatible with track system on page 287

*Compatible with track system on page 284

indoor

spencer



Brume Pendant
Àlex & Manel Lluscà

IP44  incl.

Art

110V Check p. 30



40078 ● **Structure** Anthracite
● **Diffuser** Opal



64137 ● **Structure** Old Gold
65134 ● **Structure** Black

Material	Structure Steel
	Diffuser Glass
Power	3W
Lumen Output	168lm
Light Source	SMD LED 2700K
Class	II
CRI	>80
Voltage	220V-240V/50/60Hz
Cable	1m

Material	Structure Steel
Light Source	1 E27 LED max. 15W
Bulb incl.	No
Recom. Bulb	17425
Class	I
Cable	2m

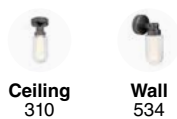

*Compatible with track system on page 287

indoor

Suspended



Diana 400



- 22005 ● Structure Black
● Diffuser Transparent
- 22006 ● Structure Dark Brown
● Diffuser Transparent
- 22007 ● Structure Matt White
● Diffuser Transparent
- 22008 ● Structure Satin Gold
● Diffuser Transparent

Diana 600



- 22011 ● Structure Black
● Diffuser Transparent
- 22012 ● Structure Dark Brown
● Diffuser Transparent
- 22013 ● Structure Matt White
● Diffuser Transparent
- 22014 ● Structure Satin Gold
● Diffuser Transparent

Diana 800



- 22017 ● Structure Black
● Diffuser Transparent
- 22018 ● Structure Dark Brown
● Diffuser Transparent
- 22019 ● Structure Matt White
● Diffuser Transparent
- 22020 ● Structure Satin Gold
● Diffuser Transparent

Material	Structure Aluminium Diffuser PC
Power	6W
Lumen Output	317lm
Light Source	SMD LED 2700K
Class	II
CRI	90
Voltage	220V-240V/50/60Hz
Beam angle	18°
Cable	1.5m

Material	Structure Aluminium Diffuser PC
Power	6W
Lumen Output	317lm
Light Source	SMD LED 2700K
Class	II
CRI	90
Voltage	220V-240V/50/60Hz
Beam angle	18°
Cable	1.5m

Material	Structure Aluminium Diffuser PC
Power	6W
Lumen Output	317lm
Light Source	SMD LED 2700K
Class	II
CRI	90
Voltage	220V-240V/50/60Hz
Beam angle	18°
Cable	1.5m

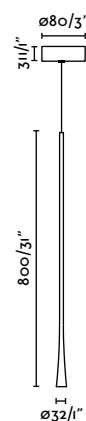
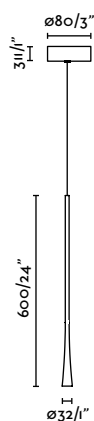
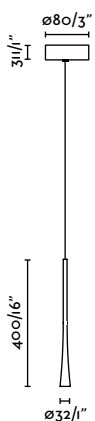

*Compatible with Neso Slim. Check our Architectural catalogue.

indoor

Suspended



With its ultra-thin, vertical hanging structure, Diana provides ideal accent lighting to bring out the finest details in any space.

Lina



- 22028 ● **Structure** Black
● **Diffuser** Translucent
- 22029 ● **Structure** White
● **Diffuser** Translucent

Material	Structure Aluminium
	Shade Aluminium
	Diffuser PC
Power	12W
Lumen Output	524lm
Light Source	LED MODULE 2700K
Class	II
CRI	90
Voltage	220V-240V/50/60Hz
Beam angle	85°
Cable	1.5m

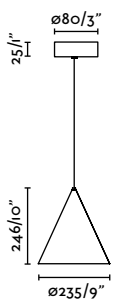

Anna



- 22032 ● **Structure** Black
● **Diffuser** Transparent
- 22033 ● **Structure** White
● **Diffuser** Transparent

Material	Structure Aluminium
	Shade Aluminium
	Diffuser PMMA
Power	4W
Lumen Output	205lm
Light Source	SMD LED 2700K
Class	II
CRI	90
Voltage	220V-240V/50/60Hz
Beam angle	18°
Cable	1.5m

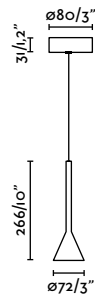

*Compatible with Neso Slim. Check our Architectural catalogue.



indoor

Suspended





Pam 165



64160  **Structure** Matt Black + Matt Gold
 **Diffuser** Opal

Pam 250



64162  **Structure** Matt Black + Matt Gold
 **Diffuser** Opal

Material	Structure Steel
	Diffuser PMMA
Power	11W
Lumen Output	1050lm
Light Source	SMD LED 3000K
Class	II
CRI	>80
Voltage	220V-240V/50/60Hz
Beam angle	120°
Cable	1.5m

Material	Structure Steel
	Diffuser PMMA
Power	24W
Lumen Output	1968lm
Light Source	SMD LED 3000K
Class	II
CRI	>80
Voltage	220V-240V/50/60Hz
Beam angle	120°
Cable	1.5m

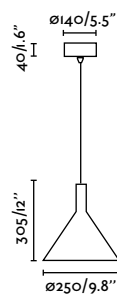
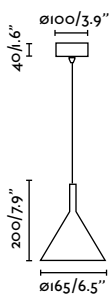

indoor

Suspended



Stan Pendant



- 43754 **Structure** Matt White + Matt Black
- 43755 **Structure** Matt Black + Matt Black
- 43756 **Structure** Satin Gold + Matt Black

Material	Structure Aluminium + ABS
Light Source	1 GU10 LED max. 5W
Bulb incl.	No
Recom. Bulb	17334
Class	I
Cable	1.2m

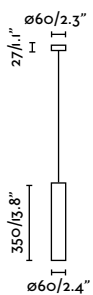
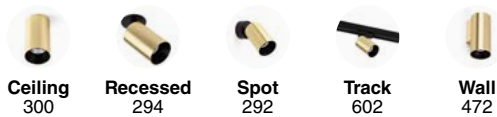

Danka

incl.



- 64223 **Structure** Satin Gold + Matt Black
- Diffuser** Transparent

Material	Structure Steel + Aluminium
	Diffuser PMMA
Power	6W
Lumen Output	440lm
Light Source	COB LED 3000K
Class	II
CRI	>80
Voltage	220V-240V/50/60Hz
Beam angle	60°
Cable	1.5m

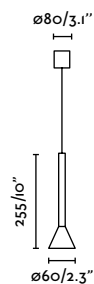

*Compatible with track system on page 287

indoor

Suspended



Cocotte Pendant 430

Jordi Llopis



incl.

110V Check p. 30



64262 ● **Structure** Gloss White
● **Diffuser** Opal

64263 ● **Structure** Gloss Black
● **Diffuser** Opal

Material Structure Aluminium

Diffuser PMMA

Power 30W

Lumen Output 2072lm

Light Source SMD LED 3000K

Class I

CRI >80

Voltage 220V-240V/50/60Hz

Cable 1.1m



Ceiling
318

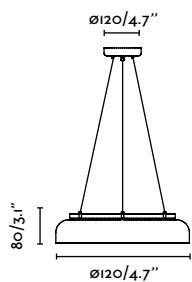

indoor

Suspended

BIENVENIDO
A CASA!!!
07. '09
GRACIAS
FAMILY!
HOLI!
COMIDA
Solo CARB
arroz
verduras
CENA
-verdura
-salmon
-membrada frutos del
bosque
mayonesa
sal coquina



Charlotte

110V Check p. 30



68563 ● Structure Matt White
● Diffuser Opal

Material	Structure Steel
	Diffuser PC
Light Source	1 E27 LED max. 15W
Bulb incl.	No
Recom. Bulb	17464
Class	I
Cable	1.2m

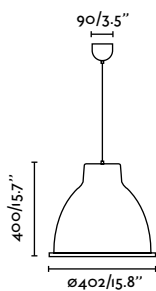

Crater

110V Check p. 30



68461 ● Structure Matt Black +
● Matt Gold

Material	Structure Aluminium
Light Source	3 E27 LED max. 15W
Bulb incl.	No
Recom. Bulb	17463
Class	II
Cable	1.5m

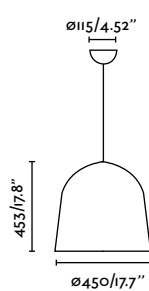

Magma

110V Check p. 30



28398 ● Structure Matt White +
● Matt Silver

28399 ● Structure Matt White +
● Matt Gold

29468 ● Structure Matt Black +
● Matt Gold

Material	Structure Fiber Glass
Light Source	3 E27 LED max. 15W
Bulb incl.	No
Recom. Bulb	17464
Class	I
Cable	2m

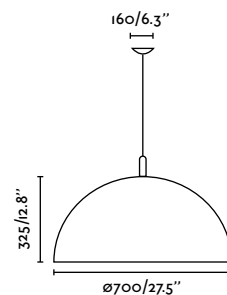

*Compatible with track system on page 287

indoor

Suspended



Loop Pendant
Estudi Ribaudí



29397 ● **Structure** Matt Black
● **Shade** Ash Wood
● **Diffuser** Translucent

29567 ● **Structure** Matt Black
● **Shade** Cherry Wood
● **Diffuser** Translucent

Material	Structure Steel
	Shade Wood
	Diffuser PMMA
Power	18W
Lumen Output	663lm
Light Source	SMD LED 2700K
Class	II
CRI	>80
Voltage	100V-240V/50/60Hz
Cable	1.2m



Table&Floor
112



Wall
428

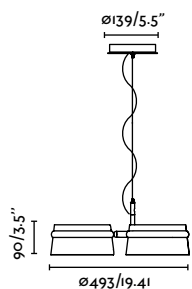

indoor

Suspended



Confetti Pendant 300

Nutcreatives



68600-50

● **Structure** Matt Black
 ● **Shade** White & Black

Confetti Pendant 450

Nutcreatives



68600-51

● **Structure** Matt Black
 ● **Shade** White & Black

Material	Structure Aluminium
	Shade Recycled PET
Light Source	1 E27 LED max. 15W
Bulb incl.	No
Recom. Bulb	17463
Class	II
Cable	1.5m

Material	Structure Aluminium
	Shade Recycled PET
Light Source	1 E27 LED max. 15W
Bulb incl.	No
Recom. Bulb	17464
Class	II
Cable	1.5m

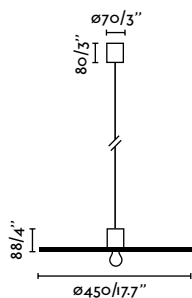
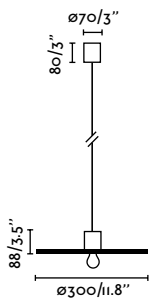

Wall
508

indoor

Suspended



Locally produced, made from recycled plastic from bottle caps.

Costas Pendant 600

Àlex & Manel Llusçà



68590-69

- Structure Matt Black
- Shade Rattan

Costas Pendant 1000

Àlex & Manel Llusçà



68590-70

- Structure Matt Black
- Shade Rattan

Material	Structure Steel
	Shade Rattan
Light Source	1 E27 LED max. 15W
Bulb incl.	No
Recom. Bulb	17426
Class	II
Cable	1.5m

Material	Structure Steel
	Shade Rattan
Light Source	1 E27 LED max. 15W
Bulb incl.	No
Recom. Bulb	17426
Class	II
Cable	1.5m



Wall
510

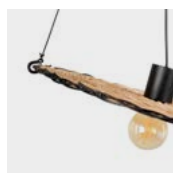
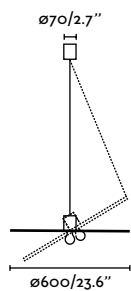

Hook accessory

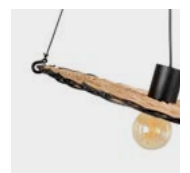
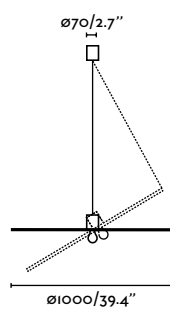

Hook accessory

indoor

Suspended



Saipan 225

Faro Lab



65134-76 ● Structure Black
● Shade Rattan

Tupai 300

Faro Lab



65134-77 ● Structure Black
● Shade Rattan

Sumba Pendant

Faro Lab



65134-72 ● Structure Black
● Shade Rattan

Material	Structure Steel Shade Rattan
Light Source	1 E27 LED max. 15W
Bulb incl.	No
Recom. Bulb	17426
Class	I
Cable	2m

Material	Structure Steel Shade Rattan
Light Source	1 E27 LED max. 15W
Bulb incl.	No
Recom. Bulb	17426
Class	I
Cable	2m

Material	Structure Steel Shade Rattan
Light Source	1 E27 LED max. 15W
Bulb incl.	No
Recom. Bulb	17426
Class	I
Cable	2m



Table
54



Wall
424

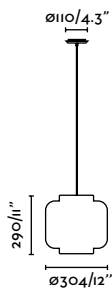
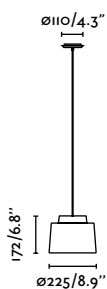

indoor

Suspended



Haka 250
Faro Lab



65134-73 ● Structure Black
● Shade Rattan

Haka 300
Faro Lab

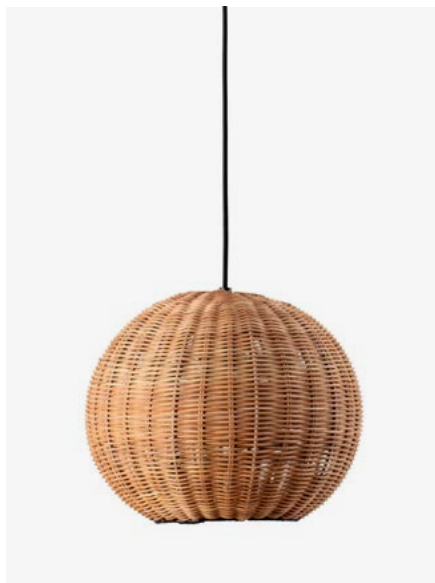

65134-74 ● Structure Black
● Shade Rattan

Haka 530
Faro Lab



65134-75 ● Structure Black
● Shade Rattan

Material	Structure Steel
	Shade Rattan
Light Source	1 E27 LED max. 15W
Bulb incl.	No
Recom. Bulb	17426
Class	I
Cable	2m

Material	Structure Steel
	Shade Rattan
Light Source	1 E27 LED max. 15W
Bulb incl.	No
Recom. Bulb	17426
Class	I
Cable	2m

Material	Structure Steel
	Shade Rattan
Light Source	1 E27 LED max. 15W
Bulb incl.	No
Recom. Bulb	17426
Class	I
Cable	2m

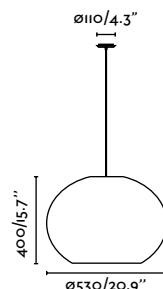
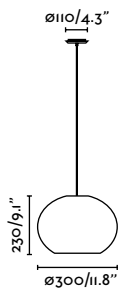
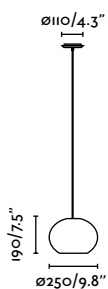

indoor

Suspended



Mambo Pendant 210

Faro Lab



Standard Canopy

64315-47 ● Structure Matt Black
● Shade Rattan

Displaced Canopy

64314-47 ● Structure Matt Black
● Shade Rattan

Material	Structure Steel
	Shade Rattan
Light Source	1 E27 LED max. 15W
Bulb incl.	No
Recom. Bulb	17463
Class	II
Cable	1.5m

Mambo Pendant 320

Faro Lab



Standard Canopy

64315-48 ● Structure Matt Black
● Shade Rattan

Displaced Canopy

64314-48 ● Structure Matt Black
● Shade Rattan

Material	Structure Steel
	Shade Rattan
Light Source	1 E27 LED max. 15W
Bulb incl.	No
Recom. Bulb	17463
Class	II
Cable	1.5m

Mambo Pendant 450

Faro Lab



Standard Canopy

64315-49 ● Structure Matt Black
● Shade Rattan

Displaced Canopy

64314-49 ● Structure Matt Black
● Shade Rattan

Material	Structure Steel
	Shade Rattan
Light Source	1 E27 LED max. 15W
Bulb incl.	No
Recom. Bulb	17463
Class	II
Cable	1.5m

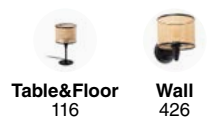

Standard Canopy

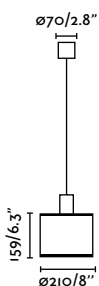

Displaced Canopy

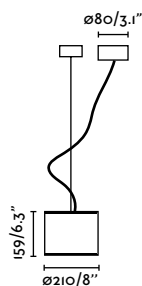

Standard Canopy

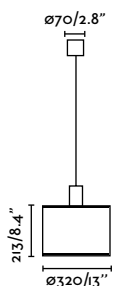

Displaced Canopy

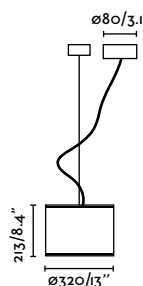

Standard Canopy

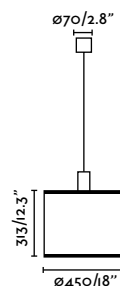

Displaced Canopy

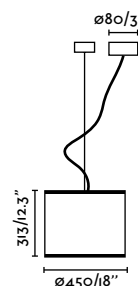

*Compatible with track system on page 287

indoor

Suspended



Savoy Pendant 420
Isaac Piñeiro



- 20308-89 Structure White
 Shade White
- 20309-90 Structure Black
 Shade Black
- 20309-91 Structure Black
 Shade Green

Material	Structure Steel
	Shade Textile
Light Source	1 E27 LED max. 15W
Bulb incl.	No
Recom. Bulb	17464
Class	II
Cable	0.8m

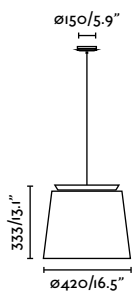
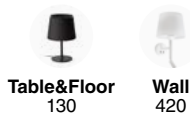

Linda Pendant
Estudi Ribaudí



- 29309 Structure Matt White
 Shade Beige
- 29313 Structure Matt Black
 Shade Beige

Material	Structure Steel
	Shade Textile
Light Source	1 E27 LED max. 15W
Bulb incl.	No
Recom. Bulb	17464
Class	I
Cable	1.2m

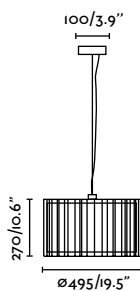

Tree Pendant
Estudi Ribaudí



- 29864 Structure Matt Black
 Shade Black
- 29865 Structure Matt White
 Shade White

Material	Structure Steel
	Shade Textile
Light Source	1 E27 LED max. 15W
Bulb incl.	No
Recom. Bulb	17464
Class	I
Cable	1.3m

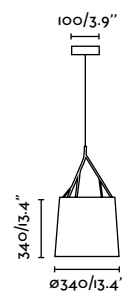

*Compatible with track system on page 287

indoor



Suspended



Aina

IP44  incl.





- 64174
-  Structure Matt White
 -  Shade White
 -  Diffuser Opal

Seven Pendant 400

110V  Check p. 30





- 68283
-  Structure Matt White
 -  Shade White
 -  Diffuser White

Seven Pendant 500

110V  Check p. 30



- 68284
-  Structure Matt White
 -  Shade White
 -  Diffuser White

Material	Structure Steel
	Shade Textile
	Diffuser PC
Power	40W
Lumen Output	3476lm
Light Source	SMD LED 2700K
Class	II
CRI	>80
Voltage	220V-240V/50/60Hz
Cable	1.3m

Material	Structure Steel
	Shade Textile
	Diffuser Textile
Light Source	2 E27 LED max. 15W
Bulb incl.	No
Recom. Bulb	17463
Class	I
Cable	0.9m

Material	Structure Steel
	Shade Textile
	Diffuser Textile
Light Source	3 E27 LED max. 15W
Bulb incl.	No
Recom. Bulb	17463
Class	I
Cable	0.9m



Ceiling
322

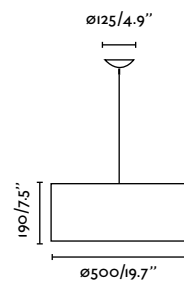
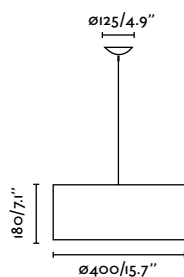
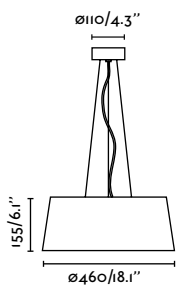

*Compatible with track system on page 287

indoor

Suspended



Conga Pendant 500

Faro Lab

110V Check p. 30



Standard Canopy

64315-54 ● Structure Matt Black
● Shade White
● Diffuser White

64315-55 ● Structure Matt Black
● Shade Beige
● Diffuser White

64315-56 ● Structure Matt Black
● Shade Black
● Diffuser White

Displaced Canopy

64314-54 ● Structure Matt Black
● Shade White
● Diffuser White

64314-55 ● Structure Matt Black
● Shade Beige
● Diffuser White

64314-56 ● Structure Matt Black
● Shade Black
● Diffuser White

Material Structure Steel
Shade Textile
Diffuser Papyrus

Light Source 1 E27 LED max. 15W

Bulb incl. No

Recom. Bulb 17464

Class II

Cable 1.5m

Vesper Pendant 600

Nahtrang

110V Check p. 30



29986 ● Structure Matt White
● Shade Beige
● Diffuser Opal

Material Structure Steel

Shade Textile

Diffuser PC

Light Source 2 E27 LED max. 15W

Bulb incl. No

Recom. Bulb 17463

Class I

Cable 2m

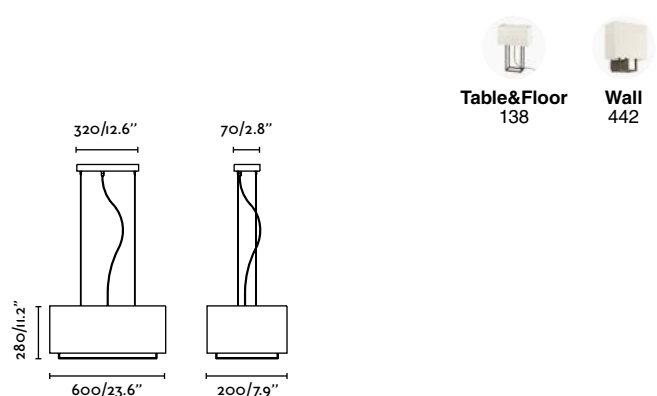
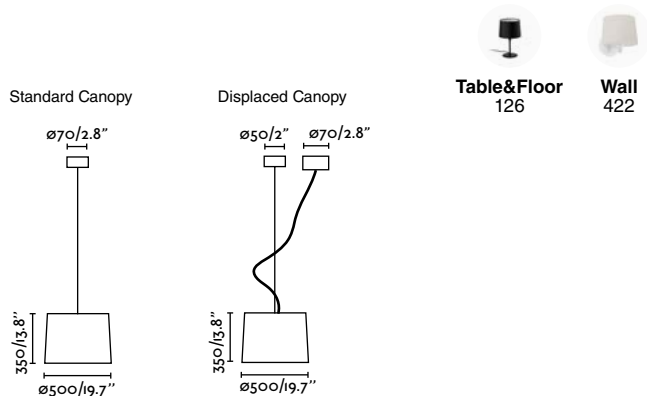

*Compatible with track system on page 287

indoor

Suspended



Samba Pendant 500

Faro Lab



Standard Canopy

64315-44 ● Structure Matt Black
● Shade Beige
● Diffuser White

64315-45 ● Structure Matt Black
● Shade Yellow
● Diffuser White

64315-46 ● Structure Matt Black
● Shade Green
● Diffuser White

Displaced Canopy

64314-44 ● Structure Matt Black
● Shade Beige
● Diffuser White

64314-45 ● Structure Matt Black
● Shade Yellow
● Diffuser White

64314-46 ● Structure Matt Black
● Shade Green
● Diffuser White

Material Structure Steel
Shade Textile
Diffuser Papyrus

Light Source 1 E27 LED max. 15W

Bulb incl. No

Recom. Bulb 17464

Class II

Cable 1.5m

Standard Canopy

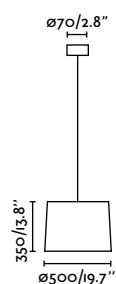

Displaced Canopy

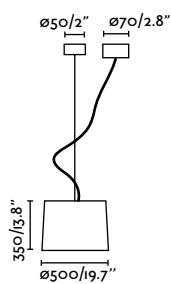

Samba Pendant 700

Faro Lab



Standard Canopy

64329-154 ● Structure Matt Black
● Shade Beige
● Diffuser White

Displaced Canopy

64330-154 ● Structure Matt Black
● Shade Beige
● Diffuser White

Material Structure Steel
Shade Textile
Diffuser Papyrus

Light Source 3 E27 LED A60 max. 45W

Bulb incl. No

Recom. Bulb 17463

Class II

Cable 1.5m

Standard Canopy

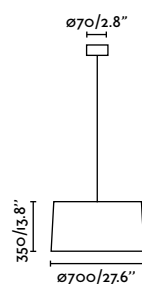

Displaced Canopy

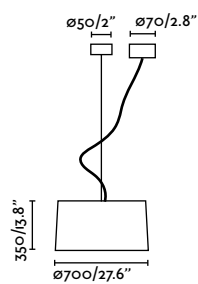

Table&Floor
124



Wall
418

*Compatible with track system on page 287

indoor

Suspended



Windsor Pendant

Faro Lab



Standard Canopy

20229-132
 ● Structure Matt Black
 ● Shade Grey
 ● Diffuser Natural

20229-153
 ● Structure Matt Black
 ● Shade Off White Linen
 ● Diffuser Natural

Displaced Canopy

20231-132
 ● Structure Matt Black
 ● Shade Grey
 ● Diffuser Natural

20231-153
 ● Structure Matt Black
 ● Shade Off White Linen
 ● Diffuser Natural

Material	Structure Steel
	Shade Textile
	Diffuser Papyrus
Light Source	3 E27 LED A60 max. 45W
Bulb incl.	No
Recom. Bulb	17463
Class	II
Cable	1.5m

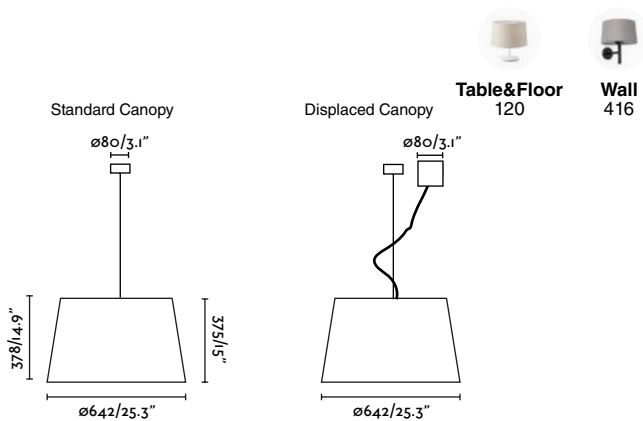

*Compatible with track system on page 287

indoor

Suspended



Extra-large lampshades for a great presence. Windsor can create ambient lighting for large spaces, such as hotels and restaurants.

Windsor 20229-132

263

Saigon In 700

Nahtrang

110V Check p. 30



20116	● Shade Beige ● Diffuser Beige
20117	● Shade White ● Diffuser Beige
20118	● Shade Terracotta ● Diffuser Beige
20119	● Shade Black ● Diffuser Beige
20120	● Shade Yellow ● Diffuser Beige
20121	● Shade Garnet ● Diffuser Beige
20122	● Shade Green ● Diffuser Beige
20123	● Shade Brown ● Diffuser Beige

Material	Structure Steel
	Shade Textile Ribbon
	Diffuser Papyrus
Light Source	3 E27 LED max. 15W
Bulb incl.	No
Recom. Bulb	17464
Class	II
Cable	1.6m

Saigon In 1300

Nahtrang

110V Check p. 30



20124	● Shade Beige ● Diffuser Beige
20125	● Shade White ● Diffuser Beige
20126	● Shade Terracotta ● Diffuser Beige
20127	● Shade Black ● Diffuser Beige
20128	● Shade Yellow ● Diffuser Beige
20129	● Shade Garnet ● Diffuser Beige
20130	● Shade Green ● Diffuser Beige
20131	● Shade Brown ● Diffuser Beige

Material	Structure Steel
	Shade Textile Ribbon
	Diffuser Papyrus
Light Source	4 E27 LED max. 15W
Bulb incl.	No
Recom. Bulb	17464
Class	II
Cable	1.6m

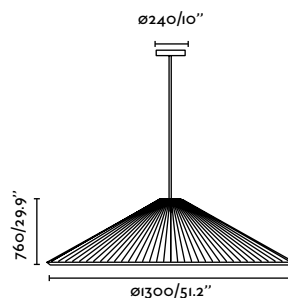
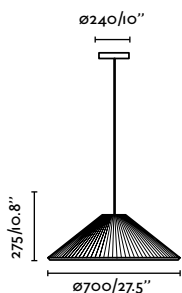

indoor

Suspended



Stood Pendant
Lucid Product Design



29848 ● **Structure** Matt Black
● **Shade** Cherry Wood

Material	Structure Steel
	Shade Cherry Wood
Light Source	1 E27 LED max. 15W
Bulb incl.	No
Recom. Bulb	17464
Class	II
Cable	2m

Stood Pendant 5L
Lucid Product Design



29849 ● **Structure** Matt Black
● **Shade** Cherry Wood

Material	Structure Steel
	Shade Cherry Wood
Light Source	5 E27 LED max. 15W
Bulb incl.	No
Recom. Bulb	17464
Class	II
Cable	2m

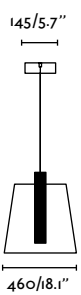
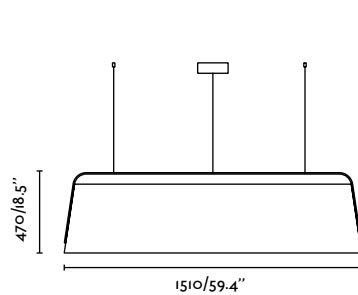
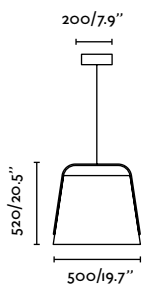
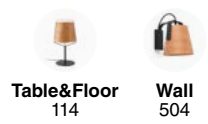

indoor

Suspended



Tatawin Glass S Circular

Adolfo Abejón



20343-116-5L ● **Structure** Satin Black
● **Shade** Opal

20343-117-5L ● **Structure** Satin Black
● **Shade** Gloss Black

Material	Structure Steel
	Shade Glass
Light Source	5 E27 LED G45 max. 15W
Bulb incl.	No
Recom. Bulb	17462
Class	II
Cable	2.5m

Tatawin Metal S Circular

Adolfo Abejón



20343-140-5L ● **Structure** Satin Black
● **Shade** Gloss White

20343-141-5L ● **Structure** Satin Black
● **Shade** Gloss Black

20343-142-5L ● **Structure** Satin Black
● **Shade** Gloss Grayish Blue

20343-143-5L ● **Structure** Satin Black
● **Shade** Gloss Reddish Orange

20343-144-5L ● **Structure** Satin Black
● **Shade** Gloss Green

Material	Structure Steel
	Shade Steel
Light Source	5 E27 LED G45 max. 15W
Bulb incl.	No
Recom. Bulb	17462
Class	II
Cable	2.5m

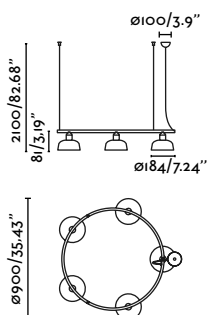

indoor

Suspended



Tatawin Glass M Circular

Adolfo Abejón



20343-119-5L ● **Structure** Satin Black
● **Shade** Opal

20343-120-5L ● **Structure** Satin Black
● **Shade** Gloss Black

Material	Structure Steel Shade Glass
Light Source	5 E27 LED max. 15W
Bulb incl.	No
Recom. Bulb	17463
Class	II
Cable	2.5m

Tatawin Metal M Circular

Adolfo Abejón



20343-145-5L ● **Structure** Satin Black
● **Shade** Gloss White

20343-146-5L ● **Structure** Satin Black
● **Shade** Gloss Black

20343-147-5L ● **Structure** Satin Black
● **Shade** Gloss Grayish Blue

20343-148-5L ● **Structure** Satin Black
● **Shade** Gloss Reddish Orange

20343-149-5L ● **Structure** Satin Black
● **Shade** Gloss Green

Material	Structure Steel Shade Steel
Light Source	5 E27 LED max. 15W
Bulb incl.	No
Recom. Bulb	17463
Class	II
Cable	2.5m

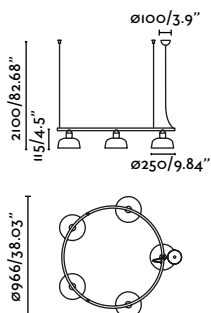
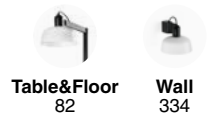

indoor

Suspended



Ligera Pendant

355°

110V Check p. 30



20079 ● Structure Matt Black

Material	Structure Steel
	Shade Steel
Light Source	6 G9 LED max. 6W
Bulb incl.	No
Recom. Bulb	17466
Class	II

Retro Pendant 12L Àlex & Manel Lluscà

110V Check p. 30



20047 ●● Structure Matt Copper + Matt Black
20048 ●● Structure Matt Black + Chrome
20051 ●● Structure Matt Black + Satin Gold

Material	Structure Steel
	Shade Steel
Light Source	12 E14 LED max. 8W
Bulb incl.	No
Recom. Bulb	17461
Class	I
Cable	3m

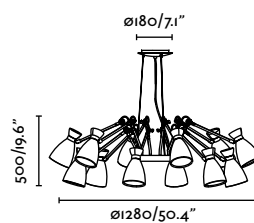
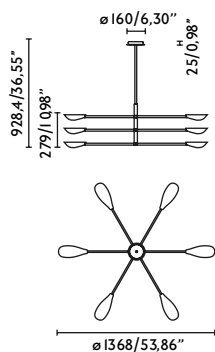
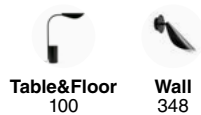

indoor

Suspended



Its soft and natural forms are inspired by ancient Japanese minimalism.

Mine Glass Pendant Space

Nahrang

110V Check p. 30



Mine Glass Pendant Space

28375-1L ● Structure Matt White
● Diffuser Opal

28376-1L ● Structure Dark Grey
● Diffuser Opal

PC

28209-1L ● Structure Matt White
● Diffuser Opal

28210-1L ● Structure Dark Grey
● Diffuser Opal

Material	Structure Aluminium
Light Source	1 E27 LED max. 15W
Bulb incl.	No
Recom. Bulb	17463
Class	II
Cable	2m

Mine Glass Pendant Space 2L

Nahrang

110V Check p. 30



Mine Glass Pendant Space

28375-2L ● Structure Matt White
● Diffuser Opal

28376-2L ● Structure Dark Grey
● Diffuser Opal

PC

28209-2L ● Structure Matt White
● Diffuser Opal

28210-2L ● Structure Dark Grey
● Diffuser Opal

Material	Structure Aluminium
Light Source	2 E27 LED max. 15W
Bulb incl.	No
Recom. Bulb	17463
Class	II
Cable	4m

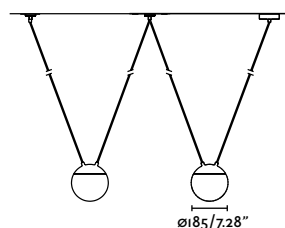
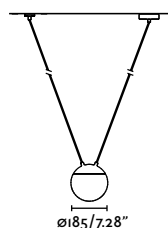

indoor

Suspended



Mine Glass Pendant Space 3L

Nahtrang

110V Check p. 30



Mine Glass Pendant Space

28375-3L ● Structure Matt White
● Diffuser Opal

28376-3L ● Structure Dark Grey
● Diffuser Opal

PC

28209-3L ● Structure Matt White
● Diffuser Opal

28210-3L ● Structure Dark Grey
● Diffuser Opal

Material	Structure Aluminium
Light Source	3 E27 LED max. 15W
Bulb incl.	No
Recom. Bulb	17463
Class	II
Cable	6m

Mine Glass Pendant Space 4L

Nahtrang

110V Check p. 30



Mine Glass Pendant Space

28375-4L ● Structure Matt White
● Diffuser Opal

28376-4L ● Structure Dark Grey
● Diffuser Opal

PC

28209-4L ● Structure Matt White
● Diffuser Opal

28210-4L ● Structure Dark Grey
● Diffuser Opal

Material	Structure Aluminium
Light Source	4 E27 LED max. 15W
Bulb incl.	No
Recom. Bulb	17463
Class	II
Cable	8m

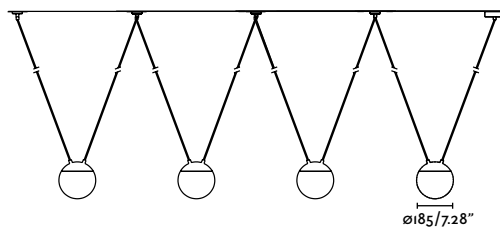
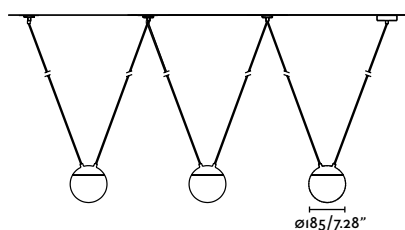



Mine Glass Pendant Space 5L

Nahtrang

110V Check p. 30

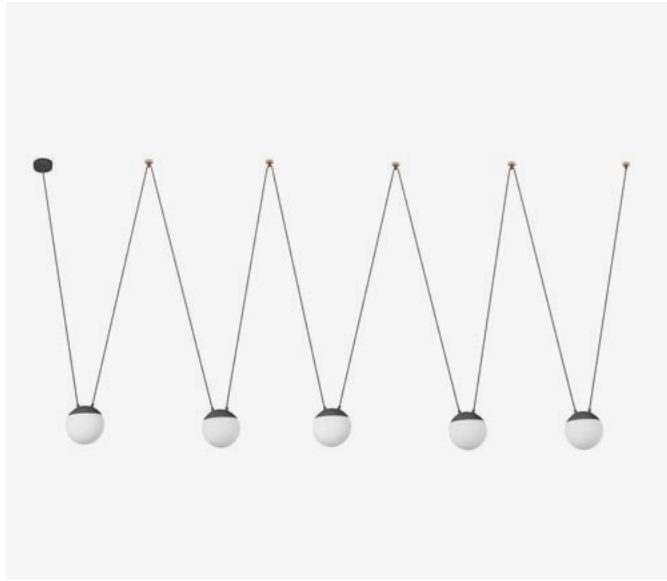

Mine Glass Pendant Space

28375-5L **Structure** Matt White
 Diffuser Opal

28376-5L **Structure** Dark Grey
 Diffuser Opal

PC

28209-5L **Structure** Matt White
 Diffuser Opal

28210-5L **Structure** Dark Grey
 Diffuser Opal

Material Structure Aluminium

Light Source 5 E27 LED max. 15W

Bulb incl. No

Recom. Bulb 17463

Class II

Cable 10m



Table&Floor
52



Hook Accessory

28373 Matt White

28374 Dark Grey



Material Structure Steel + Wood

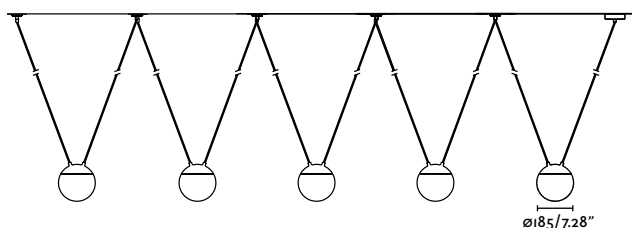

Custom version available upon request at customize@faro.es

indoor

Suspended



Installation solutions

Recessed canopy



Multiple light composition



Custom version available upon request at customize@faro.es

Multiple light composition

3 lights

5 lights

7 lights

Kombo



68591-3L
68592-3L



68591-5L
68592-5L



68591-7L
68592-7L



68593-3L
68594-3L



68593-5L
68594-5L



68593-7L
68594-7L



68595-3L
68596-3L
68597-3L



68595-5L
68596-5L
68597-5L



68595-7L
68596-7L
68597-7L



Mambo



64314-47-3L



64314-47-5L



64314-47-7L



64314-48-3L



64314-48-5L



64314-48-7L



64314-49-3L



64314-49-5L



64314-49-7L



3 lights

5 lights

7 lights

Conga



64314-54-3L ● ●
 64314-55-3L ● ●
 64314-56-3L ● ●



64314-54-5L ● ●
 64314-55-5L ● ●
 64314-56-5L ● ●



64314-54-7L ● ●
 64314-55-7L ● ●
 64314-56-7L ● ●

Samba



64314-44-3L ● ●
 64314-45-3L ● ●
 64314-46-3L ● ●



64314-44-5L ● ●
 64314-45-5L ● ●
 64314-46-5L ● ●



64314-44-7L ● ●
 64314-45-7L ● ●
 64314-46-7L ● ●

3 lights

Samba 700



64332-154 ● ●

Windsor



64332-132 ● ●
 64332-153 ● ●

Retro



20050-3L ●



20050-5L ●



20050-7L ●

3 lights

5 lights

7 lights

Plat



68145-3L
68146-3L



68145-5L
68146-5L



68145-7L
68146-7L

Art



64135-3L
64137-3L



64135-5L
64137-5L



64135-7L
64137-7L

Marlin



64133-3L



64133-5L



64133-7L

Claire



62802-3L
62803-3L



62802-5L
62803-5L



62802-7L
62803-7L

3 lights

5 lights

7 lights

Whizz



20160-3L
20161-3L



20160-5L
20161-5L



20160-7L
20161-7L



Tatawin S



20340-116-3L
20340-117-3L



20340-116-5L
20340-117-5L



20340-116-7L
20340-117-7L



Tatawin M



20340-119-3L
20340-120-3L



20340-119-5L
20340-120-5L



20340-119-7L
20340-120-7L



Tatawin Metal S



20340-140-3L
20340-141-3L
20340-142-3L
20340-143-3L
20340-144-3L



20340-140-5L
20340-141-5L
20340-142-5L
20340-143-5L
20340-144-5L



20340-140-7L
20340-141-7L
20340-142-7L
20340-143-7L
20340-144-7L



3 lights

5 lights

7 lights

Tatawin
Metal M



- 20340-145-3L ● ●
- 20340-146-3L ● ●
- 20340-147-3L ● ●
- 20340-148-3L ● ●
- 20340-149-3L ● ●

- 20340-145-5L ● ●
- 20340-146-5L ● ●
- 20340-147-5L ● ●
- 20340-148-5L ● ●
- 20340-149-5L ● ●

- 20340-145-7L ● ●
- 20340-146-7L ● ●
- 20340-147-7L ● ●
- 20340-148-7L ● ●
- 20340-149-7L ● ●

Venice 160



- 64255-115-3L ● ●
- 64255-111-3L ● ●
- 64255-112-3L ● ●
- 64255-113-3L ● ●
- 64255-114-3L ● |||

- 64255-115-5L ● ●
- 64255-111-5L ● ●
- 64255-112-5L ● ●
- 64255-113-5L ● ●
- 64255-114-5L ● |||

- 64255-115-7L ● ●
- 64255-111-7L ● ●
- 64255-112-7L ● ●
- 64255-113-7L ● ●
- 64255-114-7L ● |||

Venice 200



- 64255-124-3L ● ●
- 64255-125-3L ● ●
- 64255-126-3L ● ●
- 64255-128-3L ● ●
- 64255-127-3L ● |||

- 64255-124-5L ● ●
- 64255-125-5L ● ●
- 64255-126-5L ● ●
- 64255-128-5L ● ●
- 64255-127-5L ● |||

- 64255-124-7L ● ●
- 64255-125-7L ● ●
- 64255-126-7L ● ●
- 64255-128-7L ● ●
- 64255-127-7L ● |||

Suspended 5 Mt. cable with plug (hook incl.)

Conga

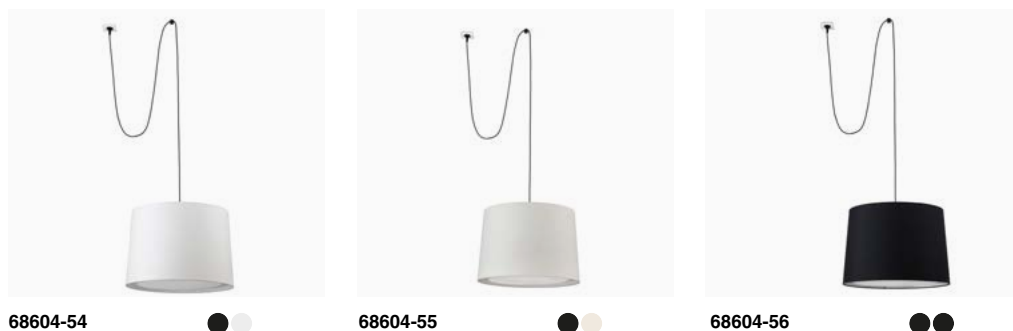

Samba

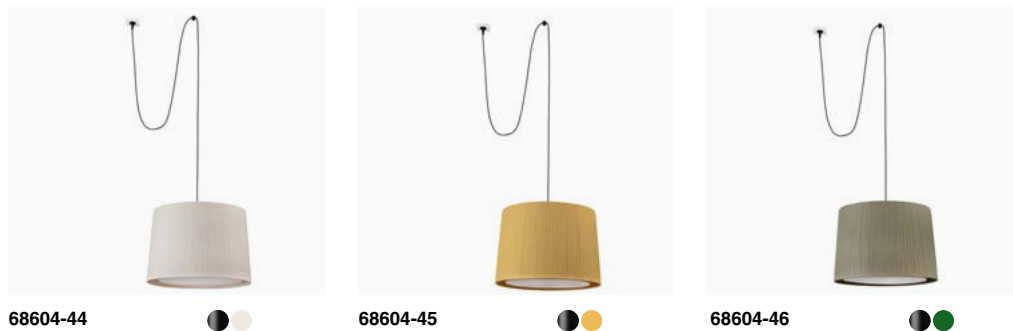

Samba 700

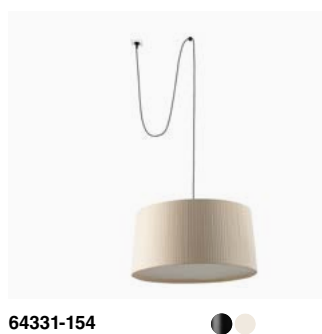

Windsor



Kombo



Mambo



Canopy recessed accessory

With frame



64231

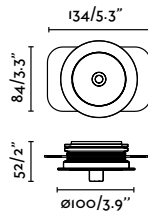

Trimless



64232

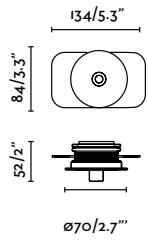

Compatible with the following configurations

<p>Electrical wire+Turnbuckle</p>	<p>Canopy with lamp holder E14 E27</p>	<p>Canopy with turnbuckle</p>	<p>Canopy with driver</p>
-----------------------------------	--	-------------------------------	---------------------------

Other solutions

Hook



68602



Track connector for suspension*

Track



01997001
01997002



*Accessories compatible with all pendants with bulb and without turnbuckle.



INDOOR

LIGHTING



CEILING



Stan Slim

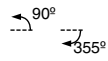

110V Check p. 30

NEW



43814	Structure White + Matt Black
43815	Structure Black + Matt Black
43816	Structure Bronze + Matt Black
43817	Structure Brushed Aluminium + Matt Black

Material	Structure Aluminium + ABS
Light Source	1 GU10 LED MR11 max. 3W
Bulb incl.	No
Recom. Bulb	17537
Class	I



Stan Slim Ring Accessory

43824	Matt White
43825	Matt Gold

Material	Structure ABS
-----------------	---------------



Stan Slim Honeycomb Accessory

43826	Black
-------	-------

Material	Structure Aluminium
-----------------	---------------------

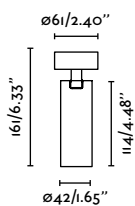



Stan LED

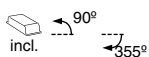

- 43726 **Structure** Matt White + Matt Black
2700K 1016lm
- 43727 **Structure** Matt Black + Matt Black
2700K 1016lm
- 43773 **Structure** Matt Black + Matt Black
3000K 942lm
- 43772 **Structure** Matt White + Matt Black
3000K 942lm

Material	Structure Aluminium + ABS
	Diffuser PC
Power	12W
Light Source	COB LED
Class	I
CRI	>90
Voltage	220V-240V/50/60Hz
Beam angle	36°

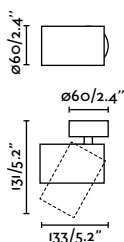

Stan GU10

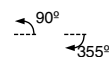

110V Check p. 30

NEW FINISH



- 43722 **Structure** Matt White + Matt Black
- 43723 **Structure** Matt Black + Matt Black
- 43762 **Structure** Satin Gold + Matt Black
- 43763 **Structure** Terracotta + Matt Black
- 43777 **Structure** Brushed Aluminium + Matt Black

Material	Structure Aluminium + ABS
Light Source	1 GU10 LED max. 5W
Bulb incl.	No
Recom. Bulb	17334
Class	I

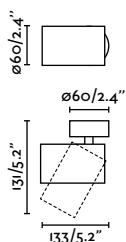
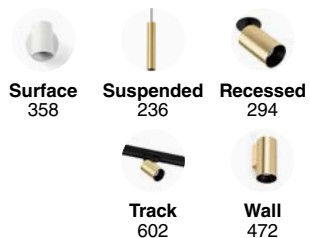



Stan Slim Recessed

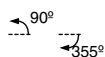

110V Check p. 30

NEW



43810 Structure White + Matt Black

43811 Structure Black + Matt Black

Material	Structure Aluminium + ABS
Light Source	1 GU10 LED MR11 max. 3W
Bulb incl.	No
Recom. Bulb	17537
Class	II
Cut out	ø38mm



Ceiling
290



Surface
358



Track
294

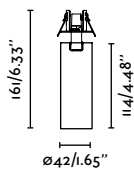

*Stan Slim accessories page 290

294

Stan Recessed

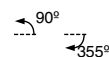

110V Check p. 30



43752 Structure Matt White + Matt Black

43753 Structure Matt Black + Matt Black

43761 Structure Satin Gold + Matt Black

Material	Structure Aluminium + ABS
Light Source	1 GU10 LED max. 5W
Bulb incl.	No
Recom. Bulb	17334
Class	I
Cut out	ø50mm



Stan Ring Accessory

43728 Matt White

43729 Matt Gold

Material Structure ABS



Stan Honeycomb Accessory

43730 Black

Material Structure Aluminium



Stan Lens Accessory

43731 Transparent

Material Structure Glass



Stan Elliptical Lens Accessory

43732 Transparent

Material Structure Glass



Recessed
294



Surface
358



Suspended
236



Track
602



Wall
472

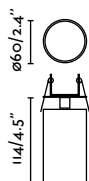



Leo Ceiling
Estudi Ribaudí

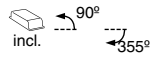

- 43790 **Structure** Matt White
- 43791 **Structure** Matt Black

Material	Structure Aluminium
Power	7W
Lumen Output	590lm
Light Source	COB LED 2700K
Class	II
CRI	≥90
Voltage	220V-240V/50/60Hz
Cut out	85mm



Leo Recessed Accessory

- 43800 **Structure** Satin Stainless

Material	Structure Steel
-----------------	------------------------



Track
604



Wall
356



Table & Floor
92

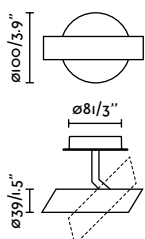

indoor

Ceiling



Link 1L
Estudi Ribaudí

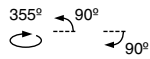

110V Check p. 30



29877 Structure Matt White
29878 Structure Matt Black

Material	Structure Steel
Light Source	1 GU10 LED max. 8W
Bulb incl.	No
Recom. Bulb	17334
Class	I

Orleans Wall
Nahtrang

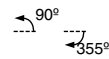

110V Check p. 30



43531 Structure Chrome +
Matt Black

Material	Structure Steel
Light Source	1 GU10 LED max. 8W
Bulb incl.	No
Recom. Bulb	17334
Class	I

Orleans Wall 2L
Nahtrang

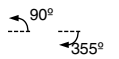

110V Check p. 30



43534 Structure Chrome +
Matt Black

Material	Structure Steel
Light Source	2 GU10 LED max. 8W
Bulb incl.	No
Recom. Bulb	17334
Class	I



Spot
454



Table&Floor
102



Wall
454



Spot
458

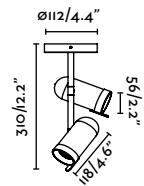
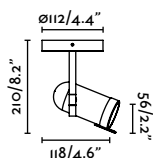
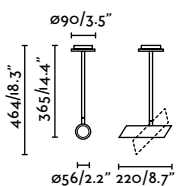

indoor

Ceiling







Stan

110V Check p. 30

NEW FINISH



- 43746  **Structure** Matt White + Matt Black
- 43747  **Structure** Matt Black + Matt Black
- 43758  **Structure** Satin Gold + Matt Black
- 43764  **Structure** Terracotta + Matt Black
- 43776  **Structure** Brushed Aluminium + Matt Black

Material	Structure Aluminium + ABS
Light Source	1 GU10 LED max. 5W
Bulb incl.	No
Recom. Bulb	17334
Class	II

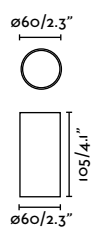





Fox

incl.

NEW



- 44501  **Structure** Black
-  **Diffuser** Transparent
- 44500  **Structure** White
-  **Diffuser** Transparent

Material	Structure Aluminium
	Diffuser Glass
Power	5W
Lumen Output	298lm
Light Source	COB LED 2700K
Class	I
CRI	90
Voltage	220V-240V/50/60Hz
Beam angle	30°

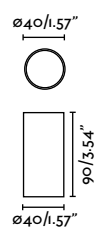

indoor

Ceiling



RoI 9W



- 68619 Structure Matt White
- 68620 Structure Matt Black

RoI 15W



- 68621 Structure Matt White
- 68622 Structure Matt Black

RoI 30W



- 68623 Structure Matt White
- 68624 Structure Matt Black

Material	Structure Aluminium + ABS
Power	9W
Lumen Output	537lm
Light Source	COB LED 2700K
Class	II
CRI	≥90
Voltage	220V-240V/50/60Hz
Beam angle	60°

Material	Structure Aluminium + ABS
Power	15W
Lumen Output	968lm
Light Source	COB LED 2700K
Class	II
CRI	≥90
Voltage	220V-240V/50/60Hz
Beam angle	60°

Material	Structure Aluminium + ABS
Power	30W
Lumen Output	1965lm
Light Source	COB LED 2700K
Class	II
CRI	≥90
Voltage	220V-240V/50/60Hz
Beam angle	60°

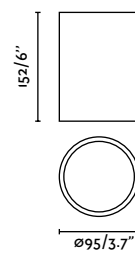
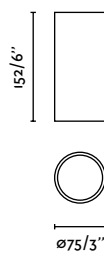
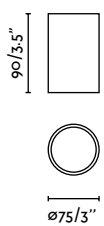



Sven R

110V Check p. 30



63268 ● Structure Matt White

Material	Structure Plaster
Light Source	1 GU10 LED max. 8W
Bulb incl.	No
Recom. Bulb	17333
Class	I

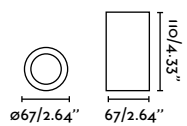

Sven SQ

110V Check p. 30



63269 ● Structure Matt White

Material	Structure Plaster
Light Source	1 GU10 LED max. 8W
Bulb incl.	No
Recom. Bulb	17333
Class	I

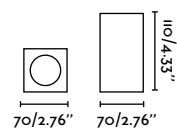



Mizu 90



68615 ● Structure Matt White
● Diffuser Opal

68616 ● Structure Matt Black
● Diffuser Prism

Material	Structure Aluminium
	Diffuser PMMA

Power	8W
--------------	----

Lumen Output	420lm
---------------------	-------

Light Source	SMD LED 2700K
---------------------	---------------

Class	II
--------------	----

CRI	≥90
------------	-----

Voltage	220V-240V/50/60Hz
----------------	-------------------

Beam angle	80°
-------------------	-----



Mizu 140



68617 ● Structure Matt White
● Diffuser Opal

68618 ● Structure Matt Black
● Diffuser Opal

Material	Structure Aluminium
	Diffuser PMMA

Power	15W
--------------	-----

Lumen Output	831lm
---------------------	-------

Light Source	SMD LED 2700K
---------------------	---------------

Class	II
--------------	----

CRI	≥90
------------	-----

Voltage	220V-240V/50/60Hz
----------------	-------------------

Beam angle	80°
-------------------	-----



With prismatic diffuser



Janet

110V Check p. 30



65137 ● Structure White +
Satin Gold

Material	Structure Steel
Light Source	1 E27 LED max. 15W
Bulb incl.	No
Recom. Bulb	17462
Class	I

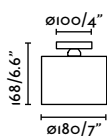

Tecto 1L

110V Check p. 30



63270 ● Structure Matt White
63271 ● Structure Matt Black

Material	Structure Aluminium
Light Source	1 GU10 LED max. 8W
Bulb incl.	No
Recom. Bulb	17320
Class	I

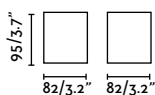

Tecto 1L AR111

no incl.

110V Check p. 30



63275 ● Structure Matt Black

Material	Structure Aluminium
Light Source	1 GX53 LED AR111 max. 15W
Bulb incl.	No
Recom. Bulb	97411
Class	III

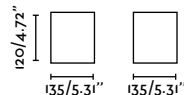



Amelia
Héctor Serrano

IP44

110V Check p. 30



- 68610 Structure Matt White
- Diffuser Opal

- 68611 Structure Matt Black
- Diffuser Opal

Material	Structure Steel
	Diffuser Glass
Light Source	1 E27 LED max. 15W
Bulb incl.	No
Recom. Bulb	17528
Class	II

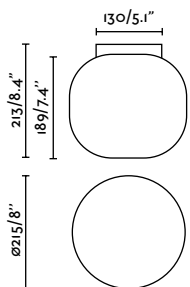

Brume
Àlex & Manel Llusçà

IP44



- 40077 Structure Anthracite
- Diffuser Opal

Material	Structure Steel
	Diffuser Glass
Power	3W
Lumen Output	168lm
Light Source	SMD LED 2700K
Class	II
CRI	>80
Voltage	220V-240V/50/60Hz

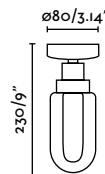
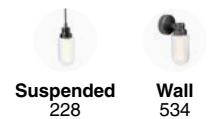



A calm lamp that blends into the space and at the same time delicately enriches it.

Tender
Nahtrang



- 20094 **Structure** Matt Black + Oak
 Diffuser Opal
- 20095 **Structure** Matt White + Oak
 Diffuser Opal

Material	Structure Steel + Wood Diffuser PC
Power	24W
Lumen Output	1800lm
Light Source	SMD LED 3000K
Class	II
CRI	>90
Voltage	220V-240V/50/60Hz

Tender
Nahtrang



- 20092 **Structure** Light Grey
 Diffuser Opal
- 20093 **Structure** Matt Black
 Diffuser Opal

Material	Structure Steel Diffuser PC
Power	24W
Lumen Output	1714lm
Light Source	SMD LED 2700K
Class	II
CRI	>90
Voltage	220V-240V/50/60Hz

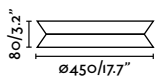

Double position

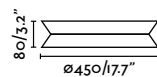

Double position



Shoku 350
Ernest Perera Studio

incl. DIM TRIAC

110V Check p. 30



- 64277 2700K 1213lm ●● Structure White + White
●● Diffuser Opal
- 64278 2700K 773lm ●● Structure White + Black
●● Diffuser Opal
- 64279 2700K 773lm ●● Structure Black + Black
●● Diffuser Opal
- 64280 2700K 1213lm ●● Structure Light Grey + White
●● Diffuser Opal

Material	Structure Aluminium Diffuser PMMA
Power	24W
Light Source	SMD LED
Class	II
CRI	>90
Voltage	220V-240V/50/60Hz

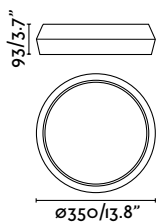

Shoku 600
Ernest Perera Studio

incl. DIM TRIAC

110V Check p. 30



- 64281 2700K 2441lm ●● Structure White + White
●● Diffuser Opal
- 64282 2700K 1980lm ●● Structure Black + Black
●● Diffuser Opal

Material	Structure Aluminium Diffuser PMMA
Power	40W
Light Source	SMD LED
Class	II
CRI	>90
Voltage	220V-240V/50/60Hz

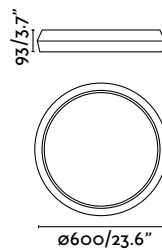

indoor

Ceiling



Side 200

Àlex & Manel Llusçà

110V Check p. 30



- 62132 Structure Matt White
 Diffuser Opal

- 62133 Structure Matt White +
Satin Nickel
 Diffuser Opal

- 62134 Structure Matt Black +
Satin Gold
 Diffuser Opal

- 62135 Structure Matt Black +
Satin Copper
 Diffuser Opal

Material	Structure Steel
	Diffuser Glass
Light Source	1 G9 LED max. 6W
Bulb incl.	No
Recom. Bulb	17443
Class	I

Side 390

Àlex & Manel Llusçà

110V Check p. 30



- 62140 Structure Matt White
 Diffuser Opal

- 62142 Structure Matt Black +
Satin Gold
 Diffuser Opal

- 62143 Structure Matt Black +
Satin Copper
 Diffuser Opal

Material	Structure Steel
	Diffuser Glass
Power	15W
Lumen Output	736lm
Light Source	SMD LED 3000K
Class	I
CRI	>80
Voltage	220V-240V/50/60Hz

incl.

Side 450

Àlex & Manel Llusçà

110V Check p. 30



- 62145 Structure Matt White +
Satin Nickel
 Diffuser Opal

- 62144 Structure Matt White
 Diffuser Opal

- 62146 Structure Matt Black +
Satin Gold
 Diffuser Opal

Material	Structure Steel
	Diffuser Glass
Power	20W
Lumen Output	1741lm
Light Source	SMD LED 3000K
Class	I
CRI	>80
Voltage	220V-240V/50/60Hz

incl.

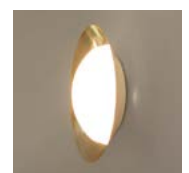
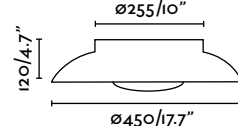
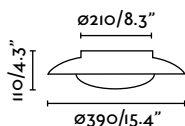
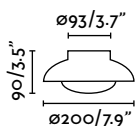
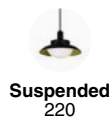

Double position

indoor

Ceiling



Dolme
Xjer Studio



- 64096 ● **Structure** Matt Black
● **Diffuser** Opal
- 64097 ● **Structure** Matt White
● **Diffuser** Opal

Material	Structure Steel Diffuser PMMA
Power	24W
Lumen Output	1260lm
Light Source	SMD LED 3000K
Class	I
CRI	>80
Voltage	220V-240V/50/60Hz



Suspended
238

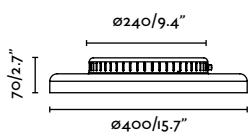

Cocotte 430
Jordi Llopis



110V Check p. 30



- 64250 ● **Structure** Gloss White
● **Diffuser** Opal
- 64251 ● **Structure** Gloss Black
● **Diffuser** Opal

Material	Structure Aluminium Diffuser PMMA
Power	30W
Lumen Output	2072lm
Light Source	SMD LED 3000K
Class	I
CRI	>80
Voltage	220V-240V/50/60Hz



Suspended
238

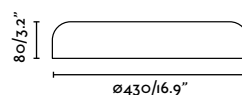



Mega
Jordi Llopis

incl. DIM TRIAC



63410 ● Structure Matt White
● Diffuser Opal

Material	Structure Aluminium
	Diffuser PMMA
Power	52W
Lumen Output	3516lm
Light Source	SMD LED 2700K
Class	I
CRI	>80
Voltage	220V-240V/50/60Hz

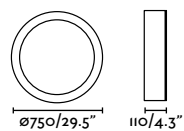

Bic

incl. DIM TRIAC



63408 ● Structure Matt White
● Diffuser Opal

Material	Structure Aluminium
	Diffuser PMMA
Power	60W
Lumen Output	4632lm
Light Source	SMD LED 3000K
Class	I
CRI	>80
Voltage	220V-240V/50/60Hz

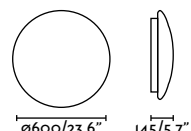



Seven 400

110V Check p. 30



- Structure Matt White
- Shade White
- Diffuser White

68298

Material	Structure Steel
	Shade Textile
	Diffuser Textile
Light Source	2 E27 LED max. 15W
Bulb incl.	No
Recom. Bulb	17463
Class	I

Seven 500

110V Check p. 30



- Structure Matt White
- Shade White
- Diffuser White

68317

Material	Structure Steel
	Shade Textile
	Diffuser Textile
Light Source	3 E27 LED max. 15W
Bulb incl.	No
Recom. Bulb	17463
Class	I



Suspended
256

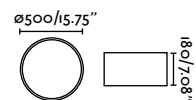
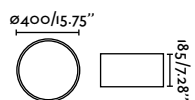



Aris 210



- 68625 Structure White
- Diffuser Opal

- 68626 Structure Black
- Diffuser Opal

Material	Structure Aluminium
	Diffuser PC
Power	20W
Lumen Output	1528lm
Light Source	SMD LED 2700K
Class	II
CRI	≥90
Voltage	220V-240V/50/60Hz
Beam angle	110°

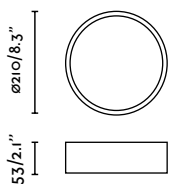

Aris 250



- 68627 Structure White
- Diffuser Opal

- 68628 Structure Black
- Diffuser Opal

Material	Structure Aluminium
	Diffuser PC
Power	30W
Lumen Output	2797lm
Light Source	SMD LED 2700K
Class	II
CRI	≥90
Voltage	220V-240V/50/60Hz
Beam angle	110°

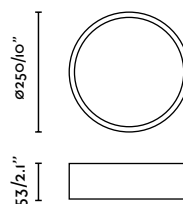



Zon

IP54 incl. DIM TRIAC



63291 Structure Matt White
Diffuser Opal

Material	Structure Steel Diffuser PMMA
Power	18W
Lumen Output	1626lm
Light Source	SMD LED 3000K
Class	II
CRI	85
Voltage	220V-240V/50Hz

Vuk

IP44 incl.



64188 Structure Matt White
Diffuser Opal
64188N Structure Matt Black
Diffuser Opal

Material	Structure Steel Diffuser PMMA
Power	40W
Lumen Output	2404lm
Light Source	SMD LED 2700K
Class	II
CRI	>80
Voltage	220V-240V/50/60Hz

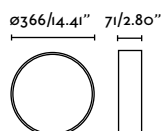

Foro

IP44 incl.



63404 Structure Matt White
Diffuser Opal

Material	Structure Aluminium Diffuser PMMA
Power	24W
Lumen Output	1900lm
Light Source	SMD LED 3000K
Class	II
CRI	>80
Voltage	220V-240V/50/60Hz

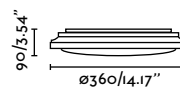



Logos 270

IP44

110V Check p. 30



62980 ● Structure Satin Nickel
● Diffuser Opal

Material	Structure Aluminium
	Diffuser PC
Light Source	1 E27 LED max. 15W
Bulb incl.	No
Recom. Bulb	17437
Class	II



Logos 350 2L

IP44

110V Check p. 30



62966 ● Structure Matt White
● Diffuser Opal
62981 ● Structure Satin Nickel
● Diffuser Opal

Material	Structure Aluminium
	Diffuser PC
Light Source	2 E27 LED max. 15W
Bulb incl.	No
Recom. Bulb	17437
Class	II

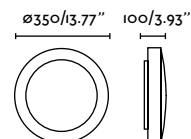

Tola 270

IP44

110V Check p. 30



62983 ● Structure Satin Nickel
● Diffuser Opal

Material	Structure Aluminium
	Diffuser PC
Light Source	1 E27 LED max. 15W
Bulb incl.	No
Recom. Bulb	17437
Class	II

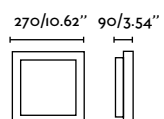

Tola 320

IP44

110V Check p. 30



62969 ● Structure Matt White
● Diffuser Opal

Material	Structure Aluminium
	Diffuser PC
Light Source	2 E27 LED max. 15W
Bulb incl.	No
Recom. Bulb	17437
Class	II

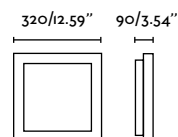



INDOOR

LIGHTING

WALL

Matilda Wall
Faro Lab



110V Check p. 30



- 20500 **Structure** Beige
- 20501 **Structure** Black
- 20502 **Structure** Garnet

Material	Structure Steel
	Shade Steel
Light Source	1 E14 LED G45 max. 15W
Bulb incl.	No
Recom. Bulb	17461
Class	II

Matilda Wall Linear
Faro Lab



110V Check p. 30



- 20508-136 **Structure** Beige
- 20509-137 **Structure** Black
- 20510-138 **Structure** Garnet

Material	Structure Steel
	Shade Steel
Light Source	1 E14 LED G45 max. 15W
Bulb incl.	No
Recom. Bulb	17461
Class	II
Cable	2.5m

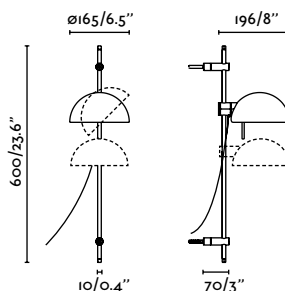
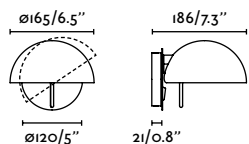

Table&Floor
75



Its rotating shade system and height adjustment offer a wide variety of lighting effects, making it a multifunctional collection.

Tatawin Wall Glass

Adolfo Abejón



20335-116 ● **Structure** Satin Black
● **Shade** Opal

20335-117 ● **Structure** Satin Black
● **Shade** Gloss Black

Material	Structure Aluminium Shade Glass
Light Source	1 E27 LED G45 max. 15W
Bulb incl.	No
Recom. Bulb	17462
Class	II

Tatawin Wall Metal

Adolfo Abejón



20335-140 ● **Structure** Satin Black
● **Shade** Gloss White

20335-141 ● **Structure** Satin Black
● **Shade** Gloss Black

20335-142 ● **Structure** Satin Black
● **Shade** Gloss Grayish Blue

20335-143 ● **Structure** Satin Black
● **Shade** Gloss Reddish Orange

20335-144 ● **Structure** Satin Black
● **Shade** Gloss Green

Material	Structure Aluminium Shade Steel
Light Source	1 E27 LED G45 max. 15W
Bulb incl.	No
Recom. Bulb	17462
Class	II

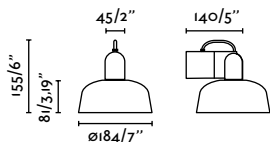

Suspended Table&Floor
198 78

The shape of the lampshade is reminiscent of the upper part of the characteristic houses of Tataouine, a city located in the South-East of Tunisia.



Venice Wall
Adolfo Abejón



64270	● Structure Gloss Black ● Shade Gloss White
64271	● Structure Gloss Black ● Shade Gloss Black
64272	● Structure Gloss Black ● Shade Gloss Pink
64273	● Structure Gloss Black Shade White & Gloss Black
64274	● Structure Gloss Black ● Shade Gloss Blue

Material	Structure Aluminium Shade Ceramic
Light Source	1 E27 LED max. 15W
Bulb incl.	No
Recom. Bulb	17463
Class	II



Suspended Table&Floor
212 84

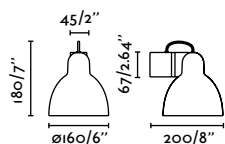



Studio Wall
Nahtrang



110V Check p. 30



28257	● Structure Matt Black ● Shade Matt Black
28258	● Structure Matt Black ● Shade Matt White
28259	● Structure Matt Black ● Shade Matt Green
28274	● Structure Matt Black ● Shade Matt Blue
28275	● Structure Matt Black ● Shade Matt Pink

Material	Structure Steel Shade Steel
Light Source	1 E14 LED max. 8W
Bulb incl.	No
Recom. Bulb	17461
Class	II



Table&Floor
96



Suspended
206



Clip-on
166

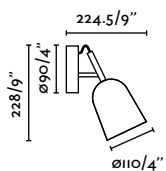



Dominica Wall
Faro Lab



- 20031-122 Structure Beige
- 20031-123 Structure Black

Material	Structure Steel
	Shade Steel
Light Source	1 E27 LED max. 15W
Bulb incl.	No
Recom. Bulb	17463
Class	II

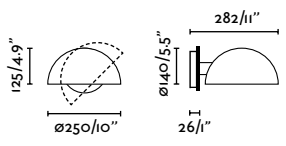

Dominica Wall Reader
Faro Lab



- 20032-122 Structure Beige
- 20032-123 Structure Black

Material	Structure Steel
	Shade Steel
Light Source	1 E27 LED max. 15W
Bulb incl.	No
Recom. Bulb	17463
Reader	1W 3000K 106lm 36°
Class	II

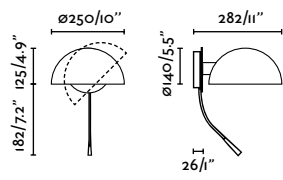

Table & Floor
88



Guadalupe Wall
Faro Lab



- 20031-80 ● Structure Black
- Shade Beige

- 20031-81 ● Structure Black
- Shade Green

Material	Structure Steel
	Shade Steel
Light Source	1 E27 LED max. 15W
Bulb incl.	No
Recom. Bulb	17463
Class	II

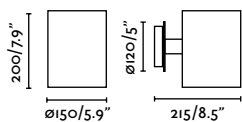

Guadalupe Wall Reader
Faro Lab

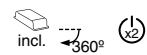

- 20032-80 ● Structure Black
- Shade Beige

- 20032-81 ● Structure Black
- Shade Green

Material	Structure Steel
	Shade Steel
Light Source	1 E27 LED max. 15W
Bulb incl.	No
Recom. Bulb	17463
Reader	1W 3000K 106lm 36°
Class	II

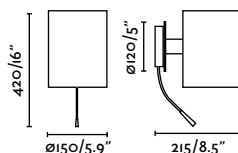

Table&Floor
98

indoor

Wall



Tila
Estudi Ribaudí

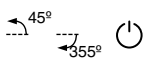

110V Check p. 30



62360 ● Structure White

62361 ● Structure Black

Material	Structure Steel
	Shade Steel
Light Source	1 E27 LED G45 max. 15W
Bulb incl.	No
Recom. Bulb	17462
Class	II

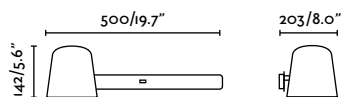

2 Installation Modes



Inviting Wall

Bohman And Folenius

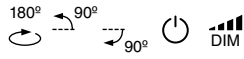

110V Check p. 30



- 57300 Structure Matt White
- Diffuser Transparent
- 57301 Structure Matt Black
- Diffuser Transparent

Material	Structure Aluminium
	Diffuser PMMA
Power	6W
Lumen Output	586lm
Light Source	SMD LED 2700-4800K
Class	II
CRI	>80
Voltage	100V-240V/50/60Hz
Cable	1.9m

Academy Wall

Nahrang

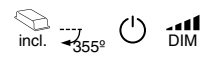

110V Check p. 30



- 28200 Structure Chrome
- Diffuser Opal

Material	Structure Steel
	Diffuser PMMA
Power	4W
Lumen Output	350lm
Light Source	SMD LED 3000K
Class	I
CRI	>80
Voltage	100V-240V/50/60Hz



Table
150



Clip
164



Table
150

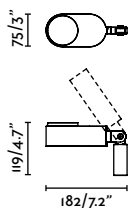

Colour temperature and intensity can be adjusted.

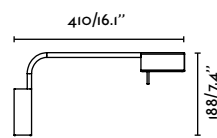
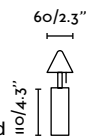



Ligera Wall

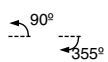

110V Check p. 30



- 20077 ● Structure Matt Black
- Shade Matt Black

Material	Structure Steel
	Shade Steel
Light Source	1 G9 LED max. 6W
Bulb incl.	No
Recom. Bulb	17466
Class	II



Suspended Table&Floor
272 100

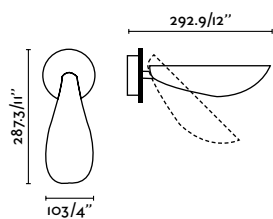

indoor

Wall

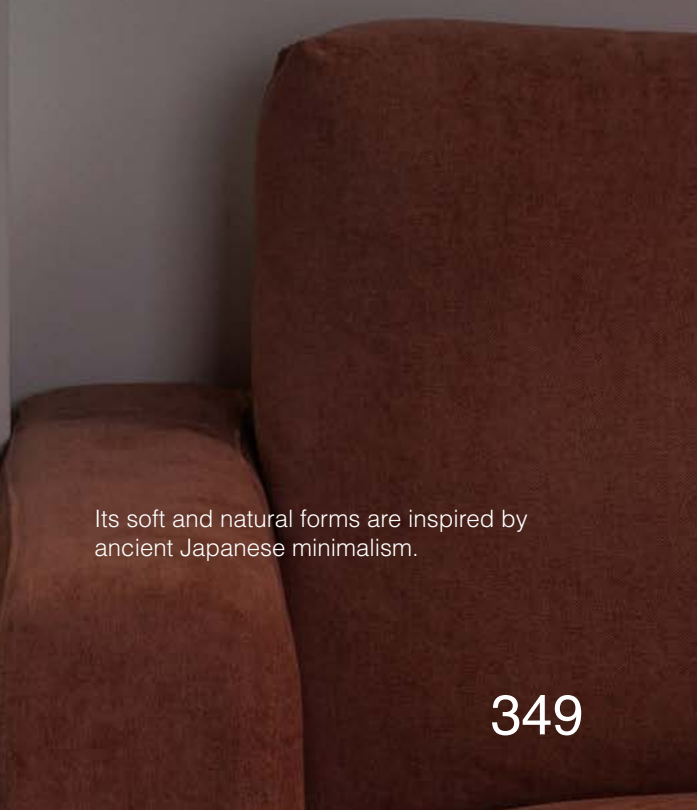
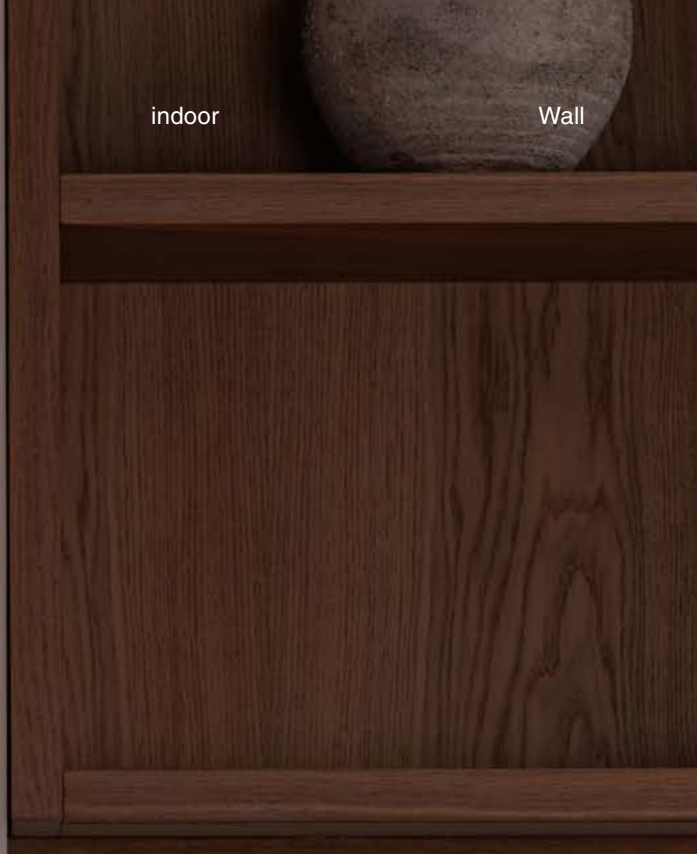

Its soft and natural forms are inspired by ancient Japanese minimalism.

Aurea
Estudi Ribaudí

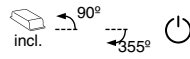

- 62115
- Structure Matt White
 - Diffuser Opal

Material	Structure Steel
	Diffuser PC
Power	8W
Lumen Output	297lm
Light Source	SMD LED 2700K
Class	I
CRI	>80
Voltage	220V-240V/50/60Hz

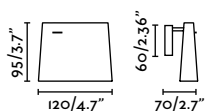

Le Petit
Àlex & Manel Llusca

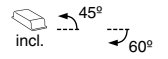

110V Check p. 30



- 62161
- Structure Matt White
- 62162
- Structure Matt Black
- 62163
- Structure Satin Gold
- 62164
- Structure Bronze

Material	Structure Steel
Power	4W
Lumen Output	88lm
Light Source	SMD LED 3000K
Class	II
CRI	>80
Voltage	100V-240V/50/60Hz

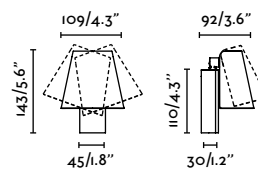



Well Induction



110V Check p. 30



64030 ● Structure Matt White
● Diffuser Opal

Material	Structure Aluminium + PP Diffuser PMMA
Power	7W
Lumen Output	248lm
Light Source	SMD LED 2700K
Class	I
CRI	≥90
Voltage	100V-240V/50Hz

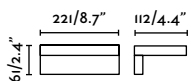

Induction charger and USB type A

Corb

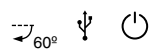

110V Check p. 30



USB Type A charger
40135 ● Structure Matt White

USB Type C charger
40136N ● Structure Matt Black

Material	Structure Aluminium
Light Source	1 GU10 LED max. 8W
Bulb incl.	No
Recom. Bulb	17316
Class	I

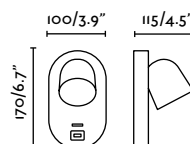

USB A or C charger



Noon
Alegre Design

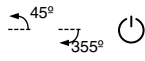

- 62355 Structure Matt White
- 62356 Structure Moss grey

Material	Structure Steel
	Shade Steel
Light Source	1 E27 LED G45 max. 15W
Bulb incl.	No
Recom. Bulb	17462
Class	II

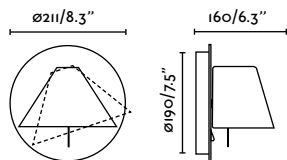

Orientable shade

Smile
Jordi Busquets

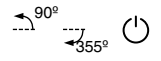

- 62130 Structure Matt White
- 62131 Structure Matt Black

Material	Structure Steel
Light Source	1 E27 LED max. 15W
Bulb incl.	No
Recom. Bulb	17463
Class	II

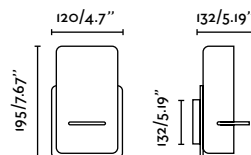

Orientable shade

indoor

Wall



Leo Wall
Estudi Ribaudí

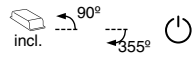



- 43792 **Structure** Matt White
- 43793 **Structure** Matt Black

Material	Structure Aluminium
Power	3,5W
Lumen Output	299lm
Light Source	COB LED 2700K
Class	II
CRI	≥90
Voltage	220V-240V/50/60Hz
Beam angle	36°
Cut out	85mm



Leo Recessed Accessory	
43800	 Satin Stainless
Material	Structure Steel

- 
Track
604
- 
Table & Floor
92
- 
Ceiling
296

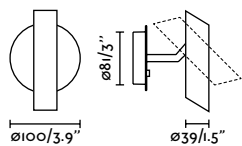



The perfect combination of versatility and design. With its focal light, Leo highlights any detail, providing precision and style.

Stan Slim Switch

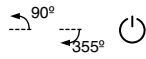

110V Check p. 30

NEW



- 43822 Structure White + Matt White
- 43823 Structure Black + Matt Black

Material	Structure Aluminium + ABS
Light Source	1 GU10 LED MR11 max. 3W
Bulb incl.	No
Recom. Bulb	17537
Class	I

Stan Switch

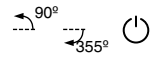

110V Check p. 30



- 43767 Structure White + Matt White
- 43768 Structure Black + Matt Black

Material	Structure Aluminium + ABS
Light Source	1 GU10 LED max. 5W
Bulb incl.	No
Recom. Bulb	17334
Class	I

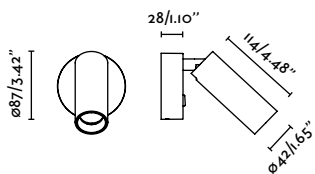

Honey Comb accessory included

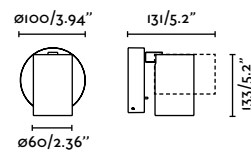

Honey Comb accessory included

indoor

Wall



Retro Wall
Àlex & Manel Llusçà

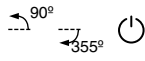

110V Check p. 30



20049 Structure Matt Black + Chrome

Material	Structure Steel
Light Source	1 E14 LED max. 8W
Bulb incl.	No
Recom. Bulb	17461
Class	I

Snap
Faro Lab

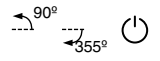

110V Check p. 30



57402 Structure Cream White + Grey

57403 Structure Dark Grey

Material	Structure Steel
Light Source	1 E27 LED max. 15W
Bulb incl.	No
Recom. Bulb	17463
Class	II



Suspended
230

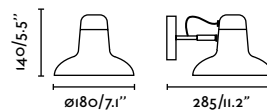
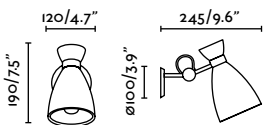

Lao Wall
Nahtrang

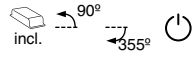

- 29039 **Structure** Matt Black + Gloss Black
- Diffuser** Opal

- 29040 **Structure** Matt White + Gloss White
- Diffuser** Opal

Material	Structure Aluminium + ABS
	Diffuser PMMA
Power	4W
Lumen Output	367lm
Light Source	SMD LED 3000K
Class	I
CRI	>80
Voltage	220V-240V/50/60Hz

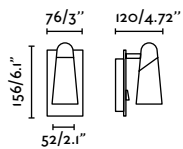

Orleans Wall
Nahtrang

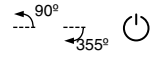

110V Check p. 30



- 43521 **Structure** Matt Black

- 43522 **Structure** Chrome + Matt Black

Material	Structure Steel
Light Source	1 GU10 LED max. 8W
Bulb incl.	No
Recom. Bulb	17334
Class	I

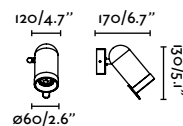

Maya
Faro Lab



- 40102 **Structure** Matt Black + Gloss Black
 Diffuser Opal

- 40103 **Structure** Matt White + Beige
 Diffuser Opal

- 40104 **Structure** Matt Black + Terracotta
 Diffuser Opal

Material	Structure Aluminium + Steel
	Diffuser Glass
Power	8W
Lumen Output	586lm
Light Source	SMD LED 2700K
Class	II
CRI	>90
Voltage	220V-240V/50/60Hz
Cable	1.5m



reddot winner 2023

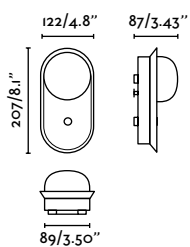

2 Installation Modes



Niko Glass Left Nahrang

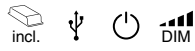

110V Check p. 30



Mine Glass Pendant Space

01014A ● Structure Matt White + Wood
● Diffuser Opal

Mine PC Pendant Space

01026A ● Structure Matt White + Wood
● Diffuser Opal

Material	Structure Aluminium + Wood
Power	7W
Lumen Output	500lm
Light Source	SMD LED 3000K
Dimmable W/lm	1/80-4/250-7/500
Class	II
CRI	>80
Voltage	100V-240V/50/60Hz

Niko Glass Right Nahrang

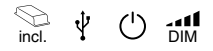

110V Check p. 30



Mine Glass Pendant Space

01009A ● Structure Matt White + Wood
● Diffuser Opal

Mine PC Pendant Space

01027A ● Structure Matt White + Wood
● Diffuser Opal

Material	Structure Aluminium + Wood
Power	7W
Lumen Output	500lm
Light Source	SMD LED 3000K
Dimmable W/lm	1/80-4/250-7/500
Class	II
CRI	>80
Voltage	100V-240V/50/60Hz



Table 50

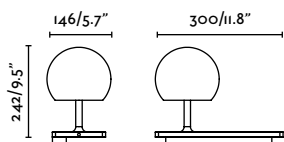

Induction charger and USB charger, type A

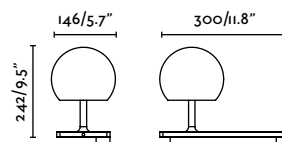

Induction charger and USB charger, type A



Nit Left
Goula / Figuera



110V Check p. 30



01004 ● Structure Matt Black

Nit Right
Goula / Figuera



110V Check p. 30



01006 ● Structure Matt Black

Material	Structure Steel
Light Source	1 E27 LED max. 15W
Bulb incl.	No
Recom. Bulb	17464
Class	II
Cable	1.7m

Material	Structure Steel
Light Source	1 E27 LED max. 15W
Bulb incl.	No
Recom. Bulb	17464
Class	II
Cable	1.7m

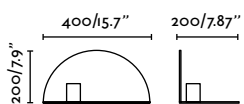

Double position

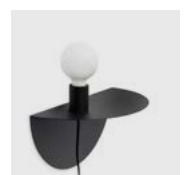
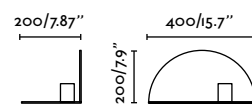

Double position



Tatawin Wall Arm Glass

Adolfo Abejón



20342-116 ● **Structure** Satin Black
● **Shade** Opal

20342-117 ● **Structure** Satin Black
● **Shade** Gloss Black

Material	Structure Steel
	Shade Glass
Light Source	1 E27 LED G45 max. 15W
Bulb incl.	No
Recom. Bulb	17462
Class	II

Tatawin Wall Arm Metal

Adolfo Abejón



20342-140 ● **Structure** Satin Black
● **Shade** Gloss White

20342-141 ● **Structure** Satin Black
● **Shade** Gloss Black

20342-142 ● **Structure** Satin Black
● **Shade** Gloss Grayish Blue

20342-143 ● **Structure** Satin Black
● **Shade** Gloss Reddish Orange

20342-144 ● **Structure** Satin Black
● **Shade** Gloss Green

Material	Structure Steel
	Shade Steel
Light Source	1 E27 LED G45 max. 15W
Bulb incl.	No
Recom. Bulb	17462
Class	II



Suspended Table&Floor
198 78

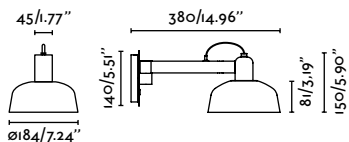



Moi,
j'veux
crever
la main
sur le
coeur

Martinica Wall Arm S

Faro Lab



- 20042-133 ● Structure Black
● Shade Black
- 20042-134 ● Structure Black
● Shade Blue
- 20042-135 ● Structure Black
● Shade Beige

Material	Structure Steel Shade Steel
Light Source	1 E27 LED ST64 max. 15W
Bulb incl.	No
Recom. Bulb	17428
Class	II
Cable	2.5m

Martinica Wall Arm XL

Faro Lab

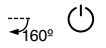

- 20040-133 ● Structure Black
● Shade Black
- 20040-134 ● Structure Black
● Shade Blue
- 20040-135 ● Structure Black
● Shade Beige

Material	Structure Steel Shade Steel
Light Source	1 E27 LED ST64 max. 15W
Bulb incl.	No
Recom. Bulb	17428
Class	II
Cable	2.5m



Table&Floor
90

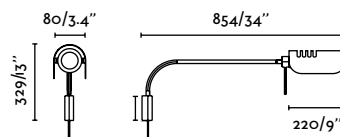
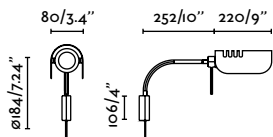

indoor

Wall



Break away from more rigid structures with Martinica. Like a sheet that melts and wraps around the lamp, its lampshade encourages us to play with light.

Dominica Wall Arm S

Faro Lab



- 20042-122 Structure Beige
- 20042-123 Structure Black

Dominica Wall Arm XL

Faro Lab

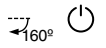

- 20040-122 Structure Beige
- 20040-123 Structure Black

Material	Structure Steel
	Shade Steel
Light Source	1 E27 LED max. 15W
Bulb incl.	No
Recom. Bulb	17463
Class	II
Cable	2.5m

Material	Structure Steel
	Shade Steel
Light Source	1 E27 LED max. 15W
Bulb incl.	No
Recom. Bulb	17463
Class	II
Cable	2.5m



Table&Floor
88

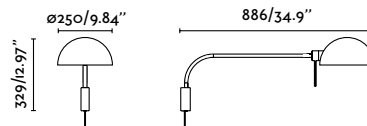
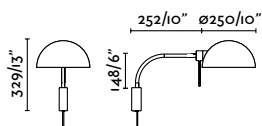



Inviting Arm Wall Bohman And Folenius

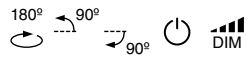

110V Check p. 30



- 57318 Structure Matt White
 Diffuser Transparent
- 57319 Structure Matt Black
 Diffuser Transparent
- 57320 Structure Yellow
 Diffuser Transparent

Material	Structure Aluminium
	Diffuser PMMA
Power	6W
Lumen Output	586lm
Light Source	SMD LED 2700-4800K
Class	II
CRI	>80
Voltage	100V-240V/50/60Hz
Cable	1.9m

Celia



110V Check p. 30



- 40070 Structure Matt Black + Satin Nickel
 Shade Matt Black

Material	Structure Steel
	Shade Steel
Light Source	1 E14 LED max. 8W
Bulb incl.	No
Recom. Bulb	17461
Class	II
Cable	1.8m



reddot award 2019
winner



Table
150



Clip
164

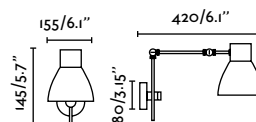
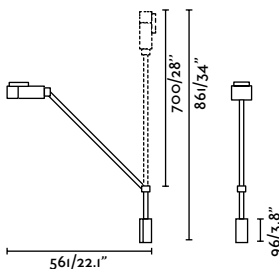

indoor

Wall



Loop Wall Articulated
Estudi Ribaudí



- 29396
 - Structure Matt Black
 - Shade Ash Wood
 - Diffuser Translucent

- 29566
 - Structure Matt Black
 - Shade Cherry Wood
 - Diffuser Translucent

Material	Structure Steel
	Shade Wood
	Diffuser PMMA
Power	6W
Lumen Output	221lm
Light Source	SMD LED 2700K
Class	II
CRI	>80
Voltage	220V-240V/50/60Hz

Pure
Nahrang



- 24528
 - Structure Matt Black
 - Diffuser Transparent

Material	Structure Steel
	Diffuser PMMA
Power	6W
Lumen Output	154lm
Light Source	SMD LED 3000K
Class	I
CRI	>80
Voltage	220V-240V/50/60Hz



Table&Floor Suspended
112 242

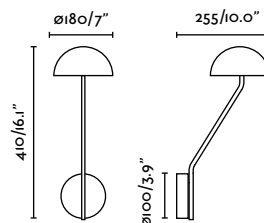
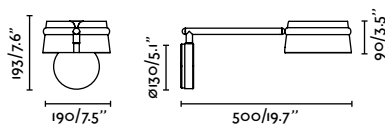



Whizz Wall Extendable
Christoph Friedrich Wagner



110V Check p. 30



- 20167 ● Structure Black
● Shade Black + Satin Gold
- 20168 ● Structure Black
● Shade Satin Gold + Black

Material	Structure Steel Shade Steel
Light Source	1 E27 LED max. 15W
Bulb incl.	No
Recom. Bulb	17496
Class	II
Cable	2m

Whizz Wall
Christoph Friedrich Wagner



ETL 110V Check p. 30



- 20165-95 ● Structure Black + Satin Gold
● Shade Black + Satin Gold
- 20165-96 ● Structure Satin Gold + Black
● Shade Satin Gold + Black

Material	Structure Steel Shade Steel
Light Source	1 E27 LED max. 15W
Bulb incl.	No
Recom. Bulb	17496
Class	II
Cable	3.4m



Table&Floor Suspended
62 214

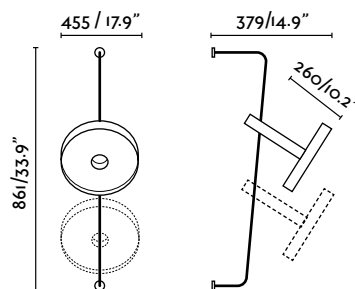
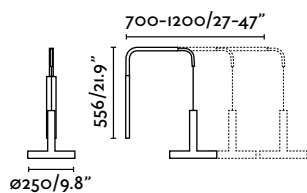



Dante Reader
Faro Lab

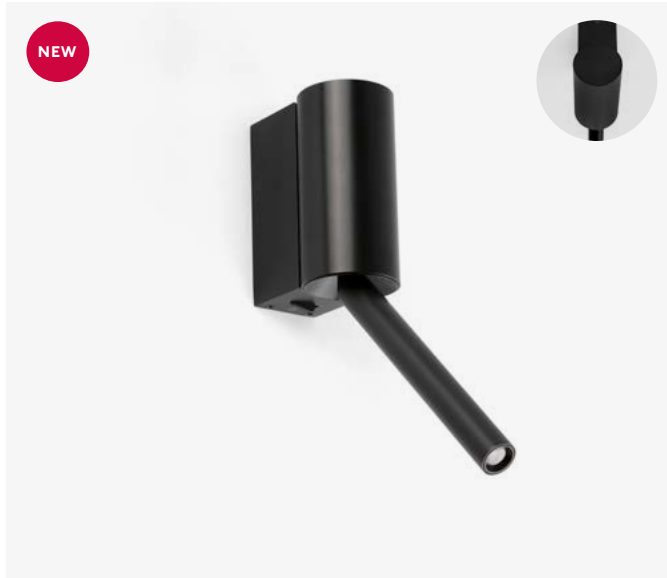
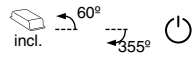

- 62730 Structure Matt White
- 62731 Structure Matt Black
- 62732 Structure Satin Gold

Material	Structure Aluminium + Steel
Power	3W
Lumen Output	116lm
Light Source	SMD LED 2700K
Reader	3W 2700K 116lm
Class	II
CRI	>95
Voltage	220V-240V/50/60Hz
Beam angle	33°

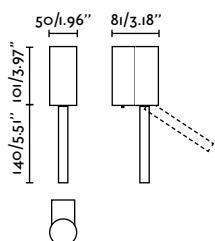

Dante Indirect Light and Reader
Faro Lab

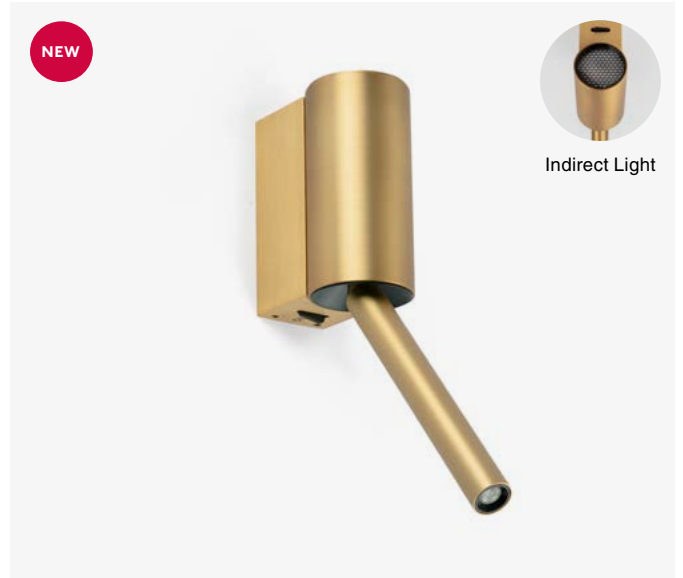
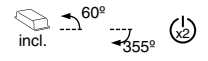

- 62734 Structure Matt White
 Diffuser Opal
- 62735 Structure Matt Black
 Diffuser Opal
- 62736 Structure Satin Gold
 Diffuser Opal

Material	Structure Aluminium + Steel
	Diffuser PC
Power	5W
Lumen Output	187lm
Light Source	COB LED 2700K
Reader	3W 2700K 116lm 33°
Class	II
CRI	97
Voltage	220V-240V/50/60Hz
Beam angle	53°

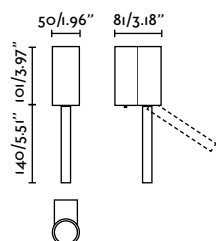

indoor

Wall



A collection designed to offer precise, comfortable reading light. Available in two versions—reader only or reader with indirect light—it combines visual comfort with a clean, understated aesthetic.

Cronos
Faro Lab

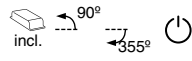

NEW
FINISH



- 62750 **Structure** Matt White + Textured Black
- 62751 **Structure** Matt Black + Textured Black
- 62752 **Structure** Bronze + Textured Black
- 62765 **Structure** Brushed Aluminium + Textured Black

Material	Structure Steel + Aluminium
Power	4W
Lumen Output	394lm
Light Source	HIGH POWER LED 2700K
Class	II
CRI	90
Voltage	220V-240V/50/60Hz
Beam angle	34°

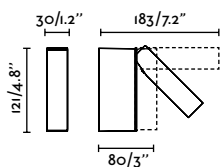

indoor

Wall



Comfortable and reliable. Its reader lights up when lifted, so there's no need to press any switch, making reading moments easier and more enjoyable.

Timit
Faro Lab

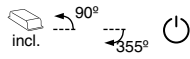

110V Check p. 30



- 62762 Structure Matt White + Textured Black
- 62763 Structure Matt Black + Textured Black

Material	Structure Steel + Aluminium
Power	4W
Lumen Output	357lm
Light Source	HIGH POWER LED 2700K
Class	II
CRI	90
Voltage	220V-240V/50/60Hz
Beam angle	34°

Timit USB
Faro Lab

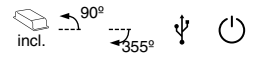

110V Check p. 30



- USB Type C charger
- 62760 Structure Matt White + Textured Black
 - 62761 Structure Matt Black + Textured Black

Material	Structure Steel + Aluminium
Power	4W
Lumen Output	357lm
Light Source	HIGH POWER LED 2700K
Class	II
CRI	90
Voltage	220V-240V/50/60Hz
Beam angle	34°

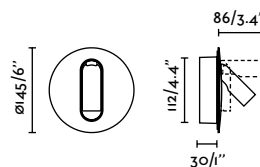
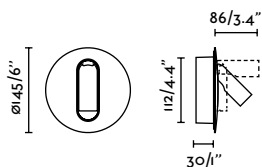



One reader, two installation options: Timit can be installed recessed or surface-mounted. Its circular shape breaks away from the straight lines found in most spaces.

Gabo
Faro Lab

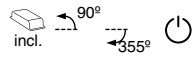

110V Check p. 30



- 62753 **Structure** Matt White + Textured Black
- 62754 **Structure** Matt Black + Textured Black
- 62755 **Structure** Bronze + Textured Black

Material	Structure Steel + Aluminium
Power	4W
Lumen Output	394lm
Light Source	HIGH POWER LED 2700K
Class	II
CRI	90
Voltage	220V-240V/50/60Hz
Beam angle	34°

Gabo USB
Faro Lab

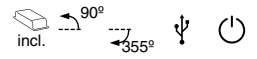

110V Check p. 30



USB Type C charger

- 62756 **Structure** Matt White + Textured Black
- 62757 **Structure** Matt Black + Textured Black
- 62758 **Structure** Bronze + Textured Black

Material	Structure Steel + Aluminium
Power	4W
Lumen Output	394lm
Light Source	HIGH POWER LED 2700K
Class	II
CRI	90
Voltage	220V-240V/50/60Hz
Beam angle	34°

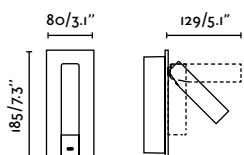

Recessed and Surface

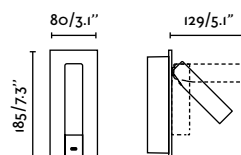

USB-C charger



Duas USB C
Faro Lab

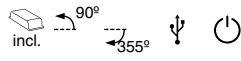

USB Type C charger

- 68467N **Structure** Matt White + Gloss White
- 68468N **Structure** Matt Black + Gloss Black

Material	Structure Steel
Power	3W
Lumen Output	98lm
Light Source	COB LED 2700K
Class	II
CRI	≥80
Voltage	100V-240V/50/60Hz
Beam angle	18°

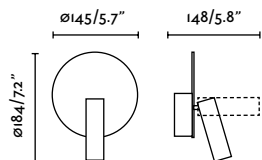

USB C charger

Click Recessed

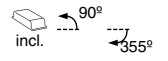

110V Check p. 30



- 43600 **Structure** Matt White
- 43600 **Diffuser** Transparent
- 43601 **Structure** Matt Black
- 43601 **Diffuser** Transparent

Material	Structure Aluminium
	Diffuser PC
Power	3,2W
Lumen Output	196lm
Light Source	SMD LED 2700K
Class	II
CRI	85
Voltage	100V-240V/50/60Hz
Cut out	ø80mm

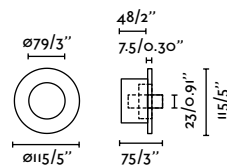

indoor

Wall



Duas 68468N

389

Suau USB
Nahtrang

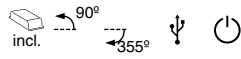

USB Type A charger

- 62116 **Structure Matt Black**
- 62117 **Structure Matt White**

USB Type C charger

- 62116N **Structure Matt Black**
- 62117N **Structure Matt White**

Material	Structure Aluminium + Steel
Power	4,5W
Lumen Output	190lm
Light Source	HIGH POWER LED 3000K
Class	I
CRI	>80
Voltage	100V-240V/50/60Hz
Beam angle	30°

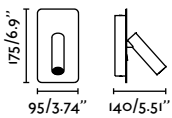

USB A or C charger

Suau
Nahtrang

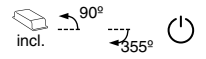

110V Check p. 30



- 62104 **Structure Bronze**
- 62118 **Structure Matt Black**
- 62120 **Structure Matt White**
- 62121 **Structure Matt Silver**

Material	Structure Aluminium + Steel
Power	4,5W
Lumen Output	193lm
Light Source	HIGH POWER LED 3000K
Class	I
CRI	>80
Voltage	100V-240V/50/60Hz
Beam angle	30°

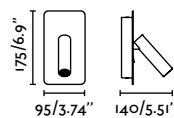

indoor

Wall



Suau Tray Right Nahrang

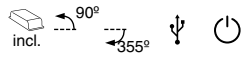

110V Check p. 30



USB Type A charger

- 62122 Structure Matt White
- 62123 Structure Matt Silver

Material	Structure Aluminium + Steel
Power	3W
Lumen Output	190lm
Light Source	HIGH POWER LED 3000K
Class	I
CRI	>80
Voltage	100V-240V/50/60Hz
Beam angle	30°

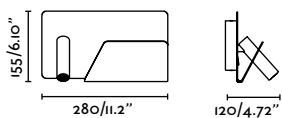

USB-A charger

Suau Recessed Nahrang

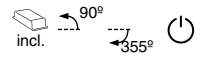

110V Check p. 30



- 62111 Structure Bronze
- 62114 Structure Satin Gold
- 62126 Structure Satin Nickel
- 62128 Structure Matt Black
- 62129 Structure Matt White

Material	Structure Aluminium + Steel
Power	4,5W
Lumen Output	193lm
Light Source	HIGH POWER LED 3000K
Class	I
CRI	>80
Voltage	100V-240V/50/60Hz
Beam angle	30°
Cut out	80x155mm

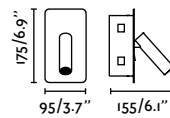



Press
Jordi Blasi

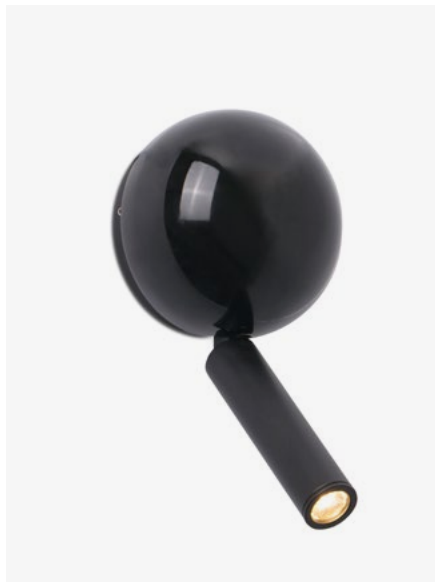
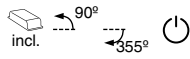

- 62350 **Structure** Gloss White + Matt Black
- 62351 **Structure** Gloss Black + Matt Black
- 62353 **Structure** Gloss Yellow + Matt Black

Material	Structure Aluminium
Power	3W
Lumen Output	253lm
Light Source	SMD LED 3000K
Class	II
CRI	>80
Voltage	220V-240V/50/60Hz
Beam angle	24°

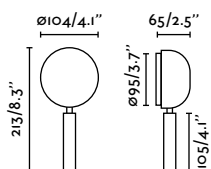

Rob Wall Reader

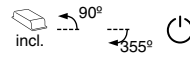

110V Check p. 30



- 68497 **Structure** Bronze
- 68499 **Structure** Satin Nickel
- 68508 **Structure** Matt White
- 68509 **Structure** Matt Black

Material	Structure Steel + Aluminium
Power	3W
Lumen Output	230lm
Light Source	HIGH POWER LED 3000K
Class	II
CRI	>80
Voltage	100V-240V/50/60Hz
Beam angle	36°

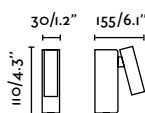
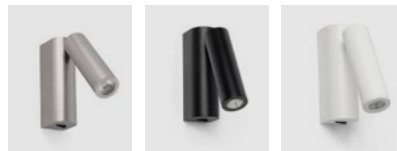

Boc

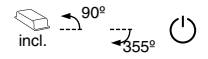

110V Check p. 30



- 62707 **Structure** Matt White
- 62708 **Structure** Matt Black
- 62710 **Structure** Chrome
- 62711 **Structure** Bronze

Material	Structure Steel
Power	3W
Lumen Output	95lm
Light Source	HIGH POWER LED 3000K
Class	II
CRI	>80
Voltage	220V-240V/50/60Hz
Beam angle	21°

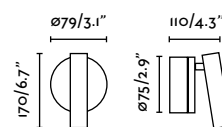
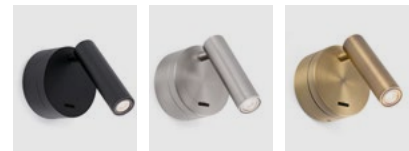



Klee Left
Isaac Piñeiro

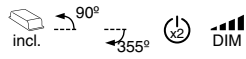

- 20066 ●● Structure Textured Grey + Black
● Diffuser Opal
- 20059 ●● Structure Textured Black + Black
● Diffuser Opal

Klee Right
Isaac Piñeiro

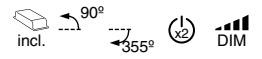

- 20065 ●● Structure Textured Grey + Black
● Diffuser Opal
- 20058 ●● Structure Textured Black + Black
● Diffuser Opal

Material	Structure Steel + Melamine
	Diffuser PMMA
Power	10W
Lumen Output	143lm
Light Source	COB LED 2700K
Dimmable W/lm	6/690-10/1021
Reader	3W 2700K 139lm 36°
Class	II
CRI	≥90
Voltage	220V-240V/50/60Hz

Material	Structure Steel + Melamine
	Diffuser PMMA
Power	10W
Lumen Output	143lm
Light Source	COB LED 2700K
Dimmable W/lm	6/690-10/1021
Reader	3W 2700K 139lm 36°
Class	II
CRI	≥90
Voltage	220V-240V/50/60Hz

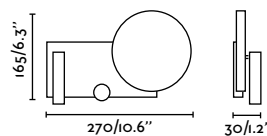
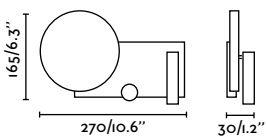



Mood SQ Reader
Nahtrang

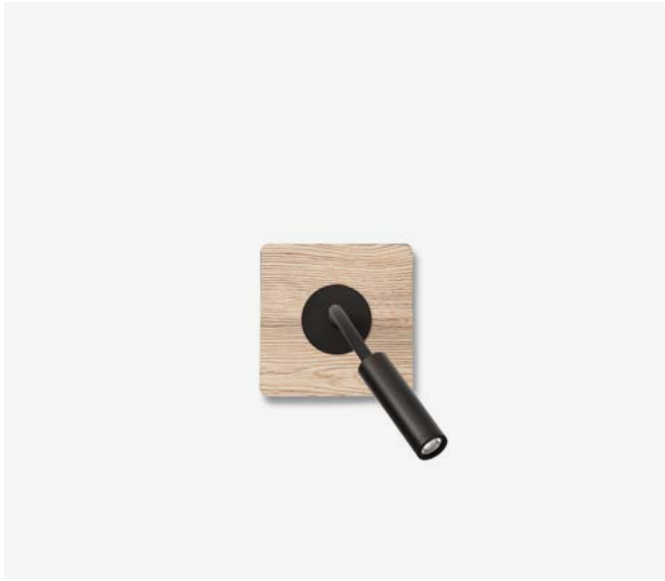
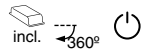

- 20060 ●● Structure Oak + Black
- 20064 ●● Structure Black + Black

Material	Structure Wood + Acier
Power	2W
Lumen Output	69lm
Light Source	SMD LED 3000K
Class	II
CRI	>80
Voltage	220V-240V/50/60Hz
Beam angle	24°

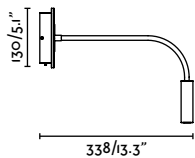

Mood RCT Reader
Nahtrang



- 20062 ●● Structure Oak + Black
● Diffuser Opal
- 20063 ●● Structure Black + Black
● Diffuser Opal

Material	Structure Wood + Acier
	Diffuser PMMA
Power	6W
Lumen Output	79lm
Light Source	SMD LED 3000K
Reader	2W 3000K 69lm 24°
Class	II
CRI	>80
Voltage	220V-240V/50/60Hz

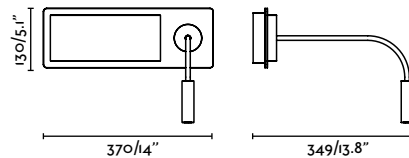



Pixie
Nahtrng

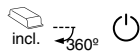

110V Check p. 30



- 24015 Structure Matt White
- 24016 Structure Matt Black

Material	Structure Aluminium
Power	4W
Lumen Output	107lm
Light Source	HIGH POWER LED 2700K
Reader	30°
Class	II
CRI	>80
Voltage	100V-240V/50/60Hz
Beam angle	45°

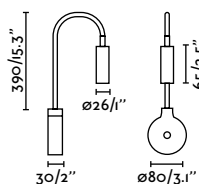

Loke Reader

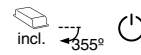

110V Check p. 30

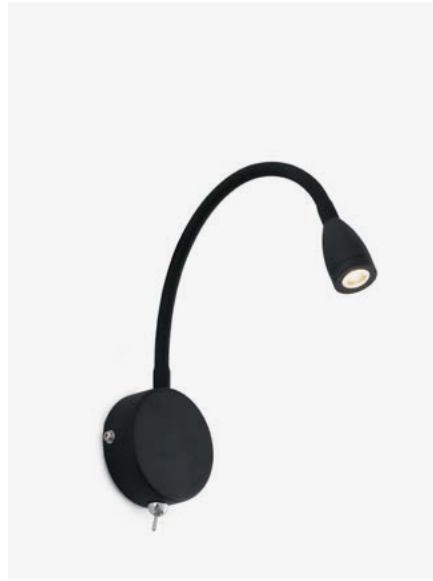

- 40994 Structure Chrome
- 41019 Structure Matt White
- 41020 Structure Matt Black

Material	Structure Aluminium + Steel
Power	3W
Lumen Output	110lm
Light Source	HIGH POWER LED 3000K
Class	II
CRI	>80
Voltage	220V-240V/50/60Hz
Beam angle	30°

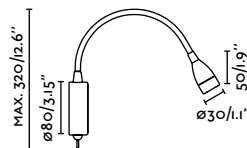

Loke Recessed

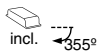

110V Check p. 30



- 40996 Structure Chrome

Material	Structure Aluminium + Steel
Power	3W
Lumen Output	110lm
Light Source	HIGH POWER LED 3000K
Class	II
CRI	>80
Voltage	220V-240V/50/60Hz
Beam angle	30°
Cut out	ø60mm

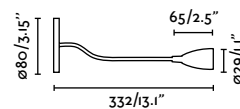



Juliet USB C

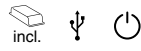

110V Check p. 30



USB Type C charger

41025NA  Structure Chrome

Material	Structure Aluminium + Steel
Power	3W
Lumen Output	117lm
Light Source	SMD LED 3000K
Class	II
CRI	>80
Voltage	100V-240V/50/60Hz
Beam angle	36°

Flin



110V Check p. 30



64318  Structure Matt White

64319  Structure Matt Black

Material	Structure Steel + Aluminium
Power	3W
Lumen Output	153lm
Light Source	HIGH POWER LED 3000K
Class	I
CRI	>80
Voltage	100V-240V/50/60Hz
Beam angle	45°

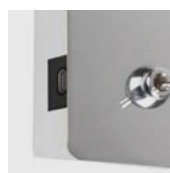
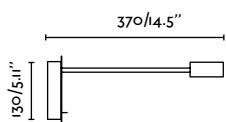

USB-C charger

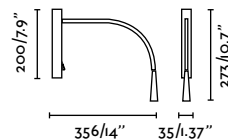

indoor

Wall



Bel



- 41029 Structure Matt White
- 41030 Structure Matt Black

Material	Structure Aluminium + Steel
Power	3W
Lumen Output	133lm
Light Source	HIGH POWER LED 3000K
Class	II
CRI	>80
Voltage	220V-240V/50/60Hz
Beam angle	30°

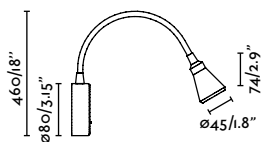

Boken



- 41031 Structure Matt White
- 41032 Structure Matt Black

Material	Structure Aluminium + Steel
Power	3W
Lumen Output	102lm
Light Source	HIGH POWER LED 3000K
Class	II
CRI	>80
Voltage	220V-240V/50/60Hz
Beam angle	30°

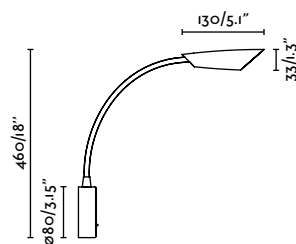

indoor

Wall



Leser



incl.



110V Check p. 30



41026  **Structure Matt Nickel + Matt Black**

Material	Structure Aluminium + Steel
Power	5W
Lumen Output	389lm
Light Source	COB LED 3000K
Class	II
CRI	>80
Voltage	100V-240V/50/60Hz
Beam angle	36°

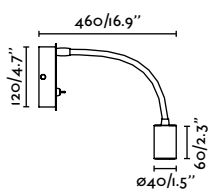

Kale

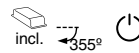

incl.

355°



110V Check p. 30



62703  **Structure Matt Black**

Material	Structure Aluminium + Steel
Power	3W
Lumen Output	117lm
Light Source	HIGH POWER LED 3000K
Class	II
CRI	>80
Voltage	220V-240V/50/60Hz
Beam angle	24°

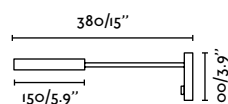

Lead



incl.

355°



110V Check p. 30



62704  **Structure Old Gold + Brown**

Material	Structure Aluminium + Leather
Power	3W
Lumen Output	144lm
Light Source	COB LED 3000K
Class	II
CRI	>80
Voltage	220V-240V/50/60Hz
Beam angle	30°

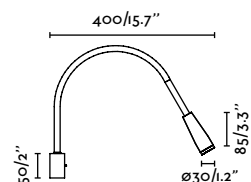

indoor

Wall





Cata

Designed by Marina Milá

Created by Marina Milá, Cata combines refined lines and warm materials to bring serenity and style to any environment. Its timeless aesthetic and balance between the natural and the modern make it both a decorative and functional must-have piece.



Cata Wall 180
Marina Milá



110V Check p. 30



20327 **Structure** Walnut
Shade Beige

Cata Wall 360
Marina Milá



110V Check p. 30



20328 **Structure** Walnut
Shade Beige

Material	Structure Walnut Wood
	Shade Papyrus
Power	2,5W
Lumen Output	45,3lm
Light Source	SMD LED 2700K
Class	II
CRI	>80
Voltage	100V-240V/50/60Hz
Cable	1.5m

Material	Structure Walnut Wood
	Shade Papyrus
Power	5W
Lumen Output	229lm
Light Source	SMD LED 2700K
Class	II
CRI	>80
Voltage	100V-240V/50/60Hz
Cable	1.5m

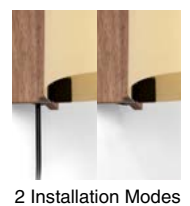
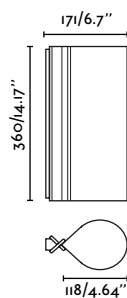
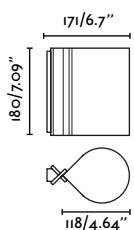

indoor

Wall

0
2
2
5



Made with FSC-certified ash wood, Cata reflects a deep respect for the environment. Its flat pack design not only optimizes storage and transport but also reduces the ecological footprint, aligning with current sustainability values.

Cata 20328

411

Dome Wall
Faro Lab

110V Check p. 30



29910 ● Structure Satin Black
● Shade Gloss White

Dome Wall Reader
Faro Lab

incl. 90° 355°

110V Check p. 30

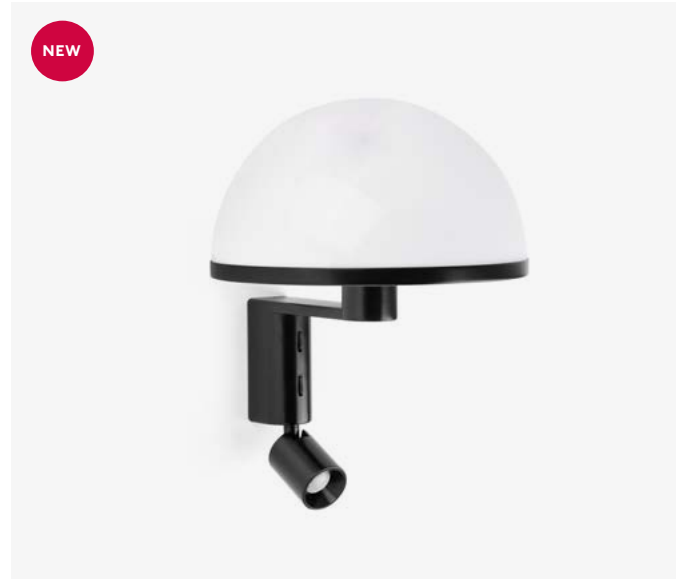

29911 ● Structure Satin Black
● Shade Gloss White

Material	Structure Aluminium
	Shade PMMA
Light Source	1 E27 LED G45 max. 15W
Bulb incl.	No
Recom. Bulb	17524
Class	II

Material	Structure Aluminium
	Shade PMMA
Light Source	1 E27 LED G45 max. 15W
Bulb incl.	No
Recom. Bulb	17524
Reader	3W 2700K 213lm 34°
Class	II

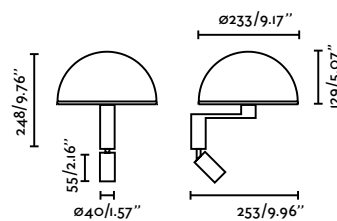
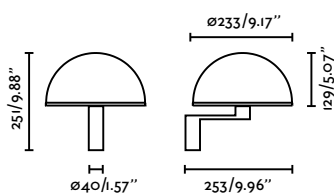



Dome is a complete family featuring a table version in two sizes, a floor lamp, a wall light and a pendant. A versatile collection designed to bring visual continuity and harmony to both contract and residential spaces.

Dome Wall Arm

Faro Lab



110V Check p. 30

NEW



29912

- Structure Satin Black
- Shade Gloss White

Material	Structure Steel
	Shade PMMA
Light Source	1 E27 LED G45 max. 15W
Bulb incl.	No
Recom. Bulb	17524
Class	II



Table&Floor Suspended
70 192

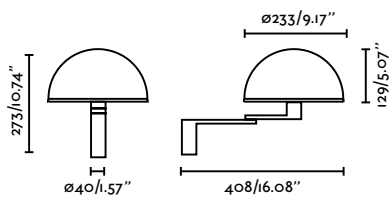



Windsor Wall
Faro Lab



- 20221-129
 - Structure Matt Black
 - Shade Grey
 - Diffuser Grey
- 20221-150
 - Structure Matt Black
 - Shade Off White
 - Diffuser Off White
- 20222-150
 - Structure Matt White
 - Shade Off White
 - Diffuser Off White

Material	Structure Steel
	Shade Textile
	Diffuser Textile
Light Source	1 E27 LED A60 max. 15W
Bulb incl.	No
Recom. Bulb	17463
Class	II

Windsor Wall Reader
Faro Lab

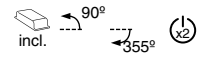

- 20223-129
 - Structure Matt Black
 - Shade Grey
 - Diffuser Grey
- 20223-150
 - Structure Matt Black
 - Shade Off White
 - Diffuser Off White
- 20224-150
 - Structure Matt White
 - Shade Off White
 - Diffuser Off White

Material	Structure Steel
	Shade Textile
	Diffuser Textile
Light Source	1 E27 LED A60 max. 15W
Bulb incl.	No
Recom. Bulb	17463
Reader	3W 3000K 177lm 24°
Class	II



Table&Floor Suspended
120 262

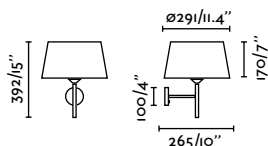

Textile diffuser

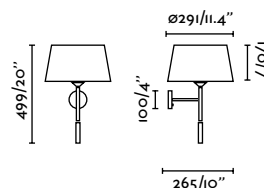

Textile diffuser

indoor

Wall



Extra-large lampshades for a great presence. Windsor can create ambient lighting for large spaces, such as hotels and restaurants.

Samba Wall

Faro Lab



64306-35	Structure Matt White Shade Beige
64306-36	Structure Matt White Shade Yellow
64306-37	Structure Matt White Shade Green
64307-35	Structure Matt Black Shade Beige
64307-36	Structure Matt Black Shade Yellow
64307-37	Structure Matt Black Shade Green

Material	Structure Steel Shade Textile
Light Source	1 E27 LED max. 15W
Bulb incl.	No
Recom. Bulb	17463
Class	I

Samba Wall Reader

Faro Lab



64308-35	Structure Matt White Shade Beige
64308-36	Structure Matt White Shade Yellow
64308-37	Structure Matt White Shade Green
64309-35	Structure Matt Black Shade Beige
64309-36	Structure Matt Black Shade Yellow
64309-37	Structure Matt Black Shade Green

Material	Structure Steel Shade Textile
Light Source	1 E27 LED max. 15W
Bulb incl.	No
Recom. Bulb	17463
Reader	3W 3000K 191lm 45°
Class	I



Suspended Table&Floor
260 124

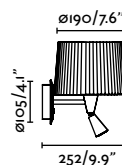
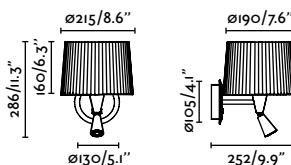
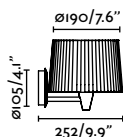
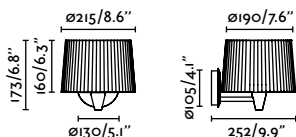

indoor

Wall



Savoy Wall
Isaac Piñeiro



- 20300-92 **Structure** Matt White
 Shade White
- 20301-93 **Structure** Matt Black
 Shade Black
- 20301-94 **Structure** Matt Black
 Shade Green

Material	Structure Steel
	Shade Textile
Light Source	1 E27 LED max. 15W
Bulb incl.	No
Recom. Bulb	17463
Class	II



Savoy Wall Reader
Isaac Piñeiro



- 20302-92 **Structure** Matt White
 Shade White
- 20303-93 **Structure** Matt Black
 Shade Black
- 20303-94 **Structure** Matt Black
 Shade Green

Material	Structure Steel
	Shade Textile
Light Source	1 E27 LED max. 15W
Bulb incl.	No
Recom. Bulb	17463
Reader	3W 3000K 177lm 24°
Class	II

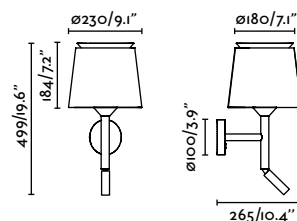
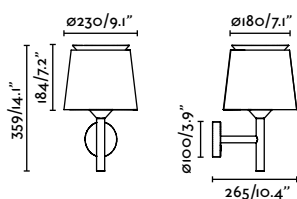



Conga Wall
Faro Lab



- 64306-01 **Structure** Matt White
 Shade White

- 64306-02 **Structure** Matt White
 Shade Beige

- 64307-03 **Structure** Matt Black
 Shade Black

Material	Structure Steel
	Shade Textile
Light Source	1 E27 LED max. 15W
Bulb incl.	No
Recom. Bulb	17463
Class	I

Conga Wall Reader
Faro Lab



- 64308-01 **Structure** Matt White
 Shade White

- 64308-02 **Structure** Matt White
 Shade Beige

- 64309-03 **Structure** Matt Black
 Shade Black

Material	Structure Steel
	Shade Textile
Light Source	1 E27 LED max. 15W
Bulb incl.	No
Recom. Bulb	17463
Reader	3W 3000K 191lm 45°
Class	I



Suspended Table&Floor
258 126

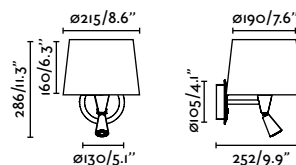
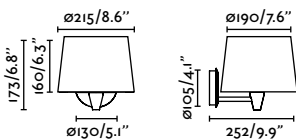



Sumba Wall
Faro Lab

no incl. 



64307-71  **Structure** Matt Black
 **Shade** Rattan

Material	Structure Steel
	Shade Rattan
Light Source	1 E27 LED max. 15W
Bulb incl.	No
Recom. Bulb	17426
Class	I

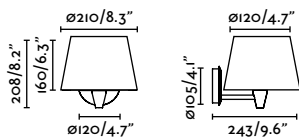

Sumba Wall Reader
Faro Lab

incl. 



64309-71  **Structure** Matt Black
 **Shade** Rattan

Material	Structure Steel
	Shade Rattan
Light Source	1 E27 LED max. 15W
Bulb incl.	No
Recom. Bulb	17426
Reader	3W 3000K 191lm 45°
Class	I

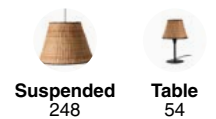
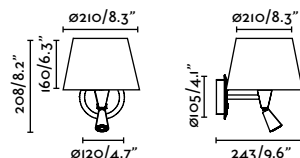



Mambo Wall

Faro Lab



64307-47

- Structure Matt Black
- Shade Rattan

Material	Structure Steel
	Shade Rattan
Light Source	1 E27 LED max. 15W
Bulb incl.	No
Recom. Bulb	17463
Class	I

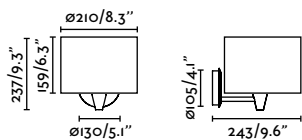

Mambo Wall Reader

Faro Lab



64309-47

- Structure Matt Black
- Shade Rattan

Material	Structure Steel
	Shade Rattan
Light Source	1 E27 LED max. 15W
Bulb incl.	No
Recom. Bulb	17463
Reader	3W 3000K 191lm 45°
Class	I

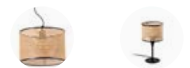
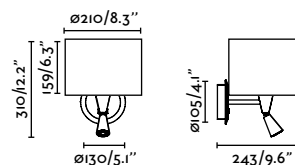

Suspended Table&Floor
286 116



Luang Wall

Faro Lab



23004-57 ● **Structure** Black
● **Shade** Beige

23004-58 ● **Structure** Black
● **Shade** Camel

Material	Structure Steel
	Shade Parchment
Light Source	1 E27 LED max. 15W
Bulb incl.	No
Recom. Bulb	17462
Class	I

Loop Wall

Estudi Ribaudí

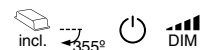

29395 ● **Structure** Matt Black
● **Shade** Ash Wood
● **Diffuser** Translucent

29565 ● **Structure** Matt Black
● **Shade** Cherry Wood
● **Diffuser** Translucent

Material	Structure Steel
	Shade Wood
	Diffuser PMMA
Power	6W
Lumen Output	221lm
Light Source	SMD LED 2700K
Class	II
CRI	>80
Voltage	220V-240V/50/60Hz



Table&Floor
108



Suspended Table&Floor
242 112

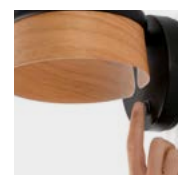
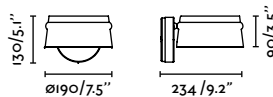
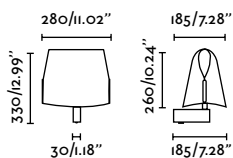

Touch dimmer

indoor

Wall

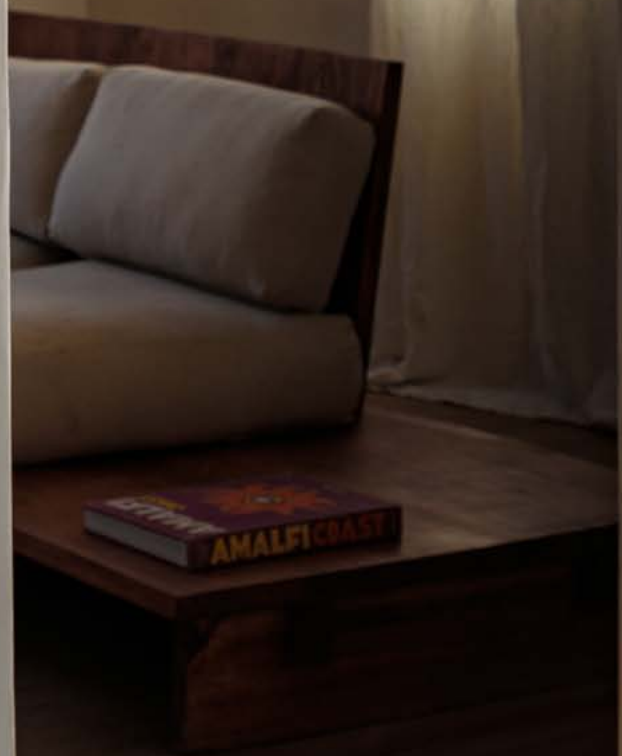

Lupe Wall
Jordi Busquets



20031-88 ● Structure Black
● Shade Beige

Lupe Wall Reader
Jordi Busquets

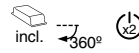

20032-88 ● Structure Black
● Shade Beige

Ron
Pepe Llaudet

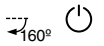

64400-10 ● Structure Dark Grey
● Shade White
64400-11 ● Structure Dark Grey
● Shade Beige
64400-12 ● Structure Dark Grey
● Shade Black

Material	Structure Steel
	Shade Textile
Light Source	1 E27 LED max. 15W
Bulb incl.	No
Recom. Bulb	17463
Class	I

Material	Structure Steel
	Shade Textile
Light Source	1 E27 LED max. 15W
Bulb incl.	No
Recom. Bulb	17463
Reader	1W 3000K 106lm 36°
Class	I

Material	Structure Steel
	Shade Textile
Light Source	1 E27 LED max. 15W
Bulb incl.	No
Recom. Bulb	17463
Class	I



Table&Floor
142

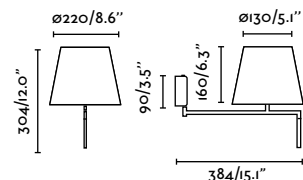
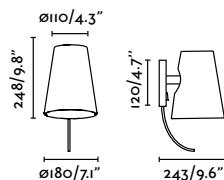
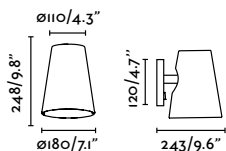

indoor







Wall



Eterna
Lucid Product Design

110V Check p. 30



- 24005-10  Structure Chrome
 Shade White
- 24005-11  Structure Chrome
 Shade Beige
- 24005-12  Structure Chrome
 Shade Black



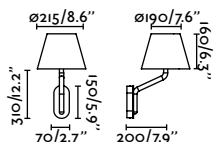



Material	Structure Steel Shade Textile
Light Source	1 E27 LED max. 15W
Bulb incl.	No
Recom. Bulb	17463
Class	II



Eterna Reader Right
Lucid Product Design

110V Check p. 30



- 24006-10  Structure Chrome
 Shade White
- 24006-11  Structure Chrome
 Shade Beige
- 24006-12  Structure Chrome
 Shade Black

Material	Structure Steel Shade Textile
Light Source	1 E27 LED max. 15W
Bulb incl.	No
Recom. Bulb	17463
Reader	1W 2700K 82lm 18°
Class	II

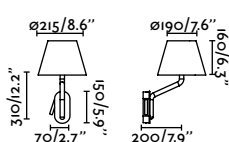







incl.

Eterna Reader Left
Lucid Product Design

110V Check p. 30



- 24007-10  Structure Chrome
 Shade White
- 24007-11  Structure Chrome
 Shade Beige
- 24007-12  Structure Chrome
 Shade Black

Material	Structure Steel Shade Textile
Light Source	1 E27 LED max. 15W
Bulb incl.	No
Recom. Bulb	17463
Reader	1W 2700K 82lm 18°
Class	II

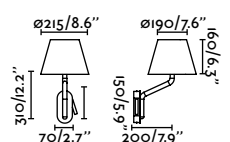



Rem Wall

Àlex & Manel Llusçà

110V Check p. 30



- 29680-19 **Structure** Matt Nickel
 Shade White
- 29680-20 **Structure** Matt Nickel
 Shade Beige
- 29680-21 **Structure** Matt Nickel
 Shade Black
- 29681-19 **Structure** Old Gold
 Shade White
- 29681-20 **Structure** Old Gold
 Shade Beige
- 29681-21 **Structure** Old Gold
 Shade Black

Material **Structure** Steel
Shade Textile

Light Source 1 E27 LED max. 15W

Bulb incl. No

Recom. Bulb 17463

Class I

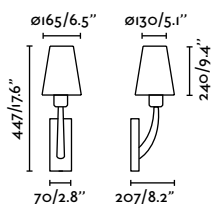

Rem Wall Reader

Àlex & Manel Llusçà

incl.

110V Check p. 30



- 29683-19 **Structure** Old Gold
 Shade White
- 29683-20 **Structure** Old Gold
 Shade Beige
- 29683-21 **Structure** Old Gold
 Shade Black

Material **Structure** Steel
Shade Textile

Light Source 1 E27 LED max. 15W

Bulb incl. No

Recom. Bulb 17463

Reader 4W 3000K 148lm 36°

Class I

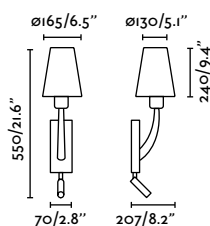

Table&Floor
132



Frame Nahtrang



110V Check p. 30



20170-01	● Structure Matt Nickel ● Shade White
20170-02	● Structure Matt Nickel ● Shade Beige
20170-03	● Structure Matt Nickel ● Shade Black
20171-01	● Structure Old Gold ● Shade White
20171-02	● Structure Old Gold ● Shade Beige
20171-03	● Structure Old Gold ● Shade Black

Material Structure Steel
Shade Textile

Light Source 1 E27 LED max. 15W

Bulb incl. No

Recom. Bulb 17463

Class I

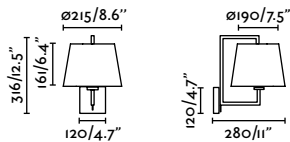

Frame Reader Nahtrang



110V Check p. 30



20173-01	● Structure Old Gold ● Shade White
20173-02	● Structure Old Gold ● Shade Beige
20173-03	● Structure Old Gold ● Shade Black

Material Structure Steel
Shade Textile

Light Source 1 E27 LED max. 15W

Bulb incl. No

Recom. Bulb 17463

Reader 3W 3000K 101lm 36°

Class I

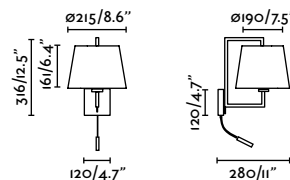



Fold
Nutcreatives



64303 ● **Structure** Matt Black
● **Shade** Black

Material	Structure Steel
	Shade Textile
Light Source	1 E27 LED max. 15W
Bulb incl.	No
Recom. Bulb	17463
Class	I

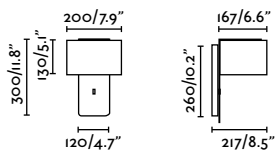

Fold Reader
Nutcreatives



64304 ● **Structure** Matt White
● **Shade** White
64305 ● **Structure** Matt Black
● **Shade** Black

Material	Structure Steel
	Shade Textile
Light Source	1 E27 LED max. 15W
Bulb incl.	No
Recom. Bulb	17463
Reader	3W 3000K 196lm 36°
Class	I

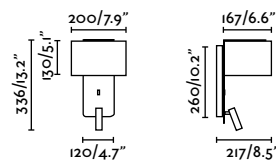



Room
Àlex & Manel Lluscà



110V Check p. 30



29974 ● **Structure** Satin Nickel
● **Shade** White

29975 ● **Structure** Satin Nickel
● **Shade** Black

Material	Structure Steel
	Shade Textile
Light Source	1 E27 LED max. 15W
Bulb incl.	No
Recom. Bulb	17463
Class	I

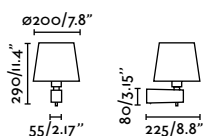

Room Reader
Àlex & Manel Lluscà



110V Check p. 30



29976 ● **Structure** Satin Nickel
● **Shade** White

Material	Structure Steel
	Shade Textile
Light Source	1 E27 LED max. 15W
Bulb incl.	No
Recom. Bulb	17463
Reader	3W 3000K 198lm 18°
Class	II

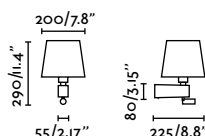

indoor

Wall



Vesper Wall
Nahtrang



110V Check p. 30



- 29980 **Structure** Matt White
- Shade** Beige

- 29981 **Structure** Brown
- Shade** Beige

Material	Structure Steel
	Shade Textile
Light Source	1 E14 LED max. 8W
Bulb incl.	No
Recom. Bulb	17461
Class	I

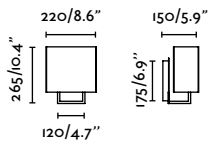

Vesper Wall Reader
Nahtrang



110V Check p. 30



- 29982 **Structure** Matt White
- Shade** Beige

- 29983 **Structure** Brown
- Shade** Beige

Material	Structure Steel
	Shade Textile
Light Source	1 E14 LED max. 8W
Bulb incl.	No
Recom. Bulb	17461
Reader	1W 3000K 93lm 30°
Class	I

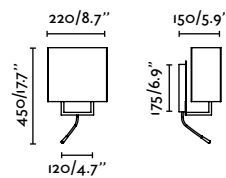

Suspended Table&Floor
258 138

indoor

Wall



Handy
Jordi Blasi



110V Check p. 30



- 28413
- Structure Matt White
 - Shade White

Material	Structure Steel
	Shade Textile
Light Source	1 E27 LED max. 15W
Bulb incl.	No
Recom. Bulb	17463
Class	I

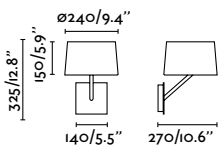

Berni
Nahrang



110V Check p. 30



- 29326
- Structure Matt White
 - Shade White
- 29328
- Structure Satin Nickel
 - Shade White

Material	Structure Steel
	Shade Textile
Light Source	1 E27 LED max. 15W
Bulb incl.	No
Recom. Bulb	17463
Class	I

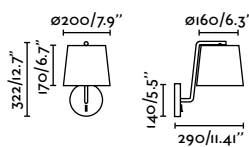

Berni Reader
Nahrang



110V Check p. 30



- 29329
- Structure Matt White
 - Shade White
- 29330
- Structure Matt Black
 - Shade Black
- 29331
- Structure Satin Nickel
 - Shade White

Material	Structure Steel
	Shade Textile
Light Source	1 E27 LED max. 15W
Bulb incl.	No
Recom. Bulb	17463
Reader	3W 3000K 141lm 24°
Class	I

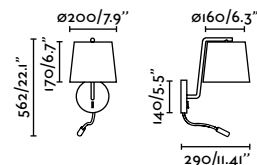

Table&Floor
146



Nila Wall



20052 ● Structure Matt Black
● Shade Off White

Material	Structure Steel
	Shade Textile
Light Source	1 E27 LED max. 15W
Bulb incl.	No
Recom. Bulb	17463
Class	I

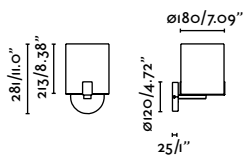

Nila Wall Reader



20053 ● Structure Matt Black
● Shade Off White

Material	Structure Steel
	Shade Textile
Light Source	1 E27 LED max. 15W
Bulb incl.	No
Recom. Bulb	17463
Reader	3W 3000K 106lm 36°
Class	I

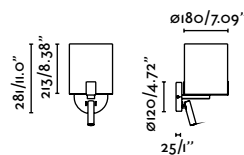

Table&Floor
136



Montreal Reader
Nahrang



110V Check p. 30



- 24033-01 Structure Chrome
 Shade White
- 24033-02 Structure Chrome
 Shade Beige
- 24033-03 Structure Chrome
 Shade Black

Material	Structure Steel Shade Textile
Light Source	1 E27 LED max. 15W
Bulb incl.	No
Recom. Bulb	17463
Reader	3W 2700K 122lm 34°
Class	II

Artis Reader
Àlex & Manel Llusçà



110V Check p. 30



- 68493-01 Structure Chrome
 Shade White
- 68493-02 Structure Chrome
 Shade Beige
- 68493-03 Structure Chrome
 Shade Black

Material	Structure Steel Shade Textile
Light Source	1 E27 LED max. 15W
Bulb incl.	No
Recom. Bulb	17463
Reader	1W 3000K 75lm 18°
Class	I

Rob Wall Shade

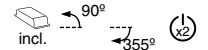

110V Check p. 30



- 68496 Structure Bronze
 Shade Opal
- 68498 Structure Satin Nickel
 Shade Opal

Material	Structure Steel + Aluminium Shade PMMA
Light Source	1 E27 LED max. 15W
Bulb incl.	No
Recom. Bulb	17463
Reader	3W 3000K 121lm 18°
Class	I



Table&Floor
128



Table&Floor
134



Wall
394

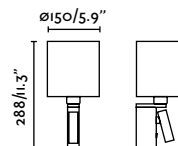
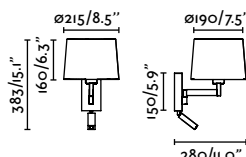
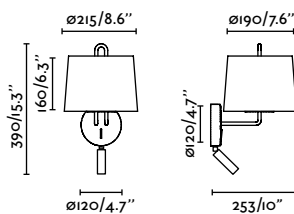



Sahara



110V Check p. 30



62706  Structure Chrome
 Shade White

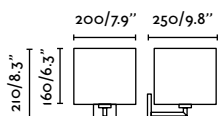

Material	Structure Steel
	Shade Textile
Light Source	1 E27 LED max. 15W
Bulb incl.	No
Recom. Bulb	17463
Class	I



Roda

110V Check p. 30



62988  Structure Satin Nickel
 Shade White

Material	Structure Steel
	Shade Textile
Light Source	1 E27 LED max. 15W
Bulb incl.	No
Recom. Bulb	17463
Class	I

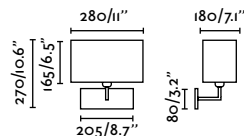



indoor

Wall

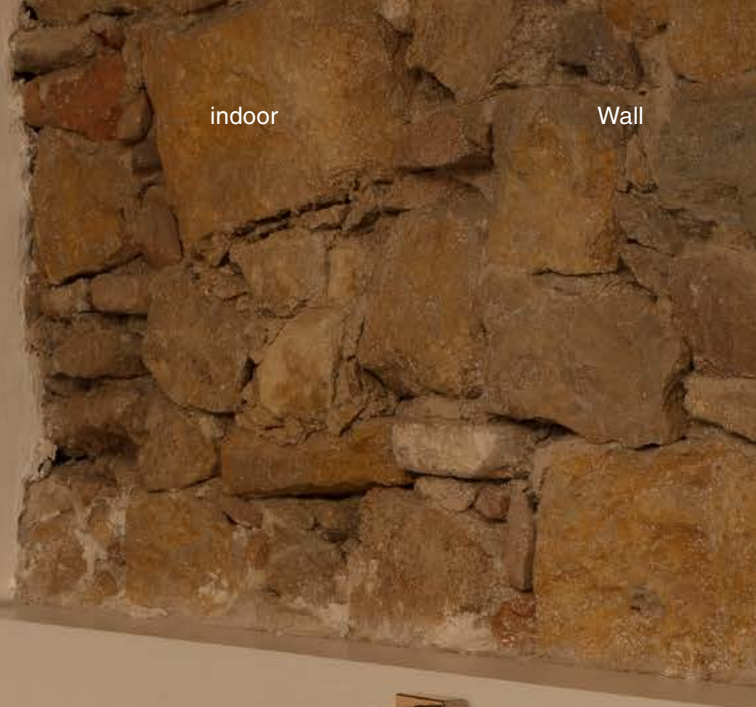

Stan 1L

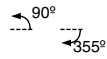

110V Check p. 30



- 43740 Structure Matt White + Matt Black
- 43741 Structure Matt Black + Matt Black

Material	Structure Aluminium + ABS
Light Source	1 GU10 LED max. 5W
Bulb incl.	No
Recom. Bulb	17334
Class	I

Stan 2L

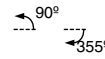

110V Check p. 30



- 43742 Structure Matt White + Matt Black
- 43743 Structure Matt Black + Matt Black

Material	Structure Aluminium + ABS
Light Source	2 GU10 LED max. 5W
Bulb incl.	No
Recom. Bulb	17334
Class	I

Stan 3L

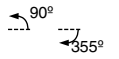

110V Check p. 30



- 43744 Structure Matt White + Matt Black
- 43745 Structure Matt Black + Matt Black

Material	Structure Aluminium + ABS
Light Source	3 GU10 LED max. 5W
Bulb incl.	No
Recom. Bulb	17334
Class	I

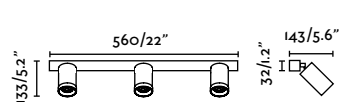
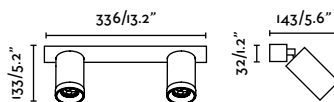
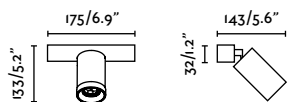

indoor

Wall



Link
Estudi Ribaudí

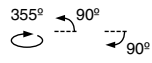

110V Check p. 30



- 29873 Structure Matt White
- 29874 Structure Matt Black
- 29897 Structure Bronze

Material	Structure Steel
Light Source	1 GU10 LED max. 8W
Bulb incl.	No
Recom. Bulb	17334
Class	I

Link 2L
Estudi Ribaudí

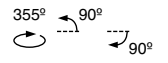

110V Check p. 30



- 29875 Structure Matt White
- 29876 Structure Matt Black

Material	Structure Steel
Light Source	2 GU10 LED max. 8W
Bulb incl.	No
Recom. Bulb	17334
Class	I

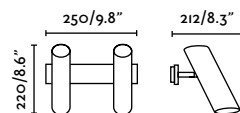
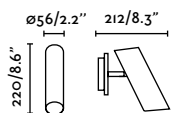
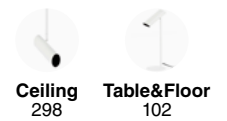



205

Coco 1L
Faro Lab

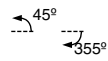

110V Check p. 30

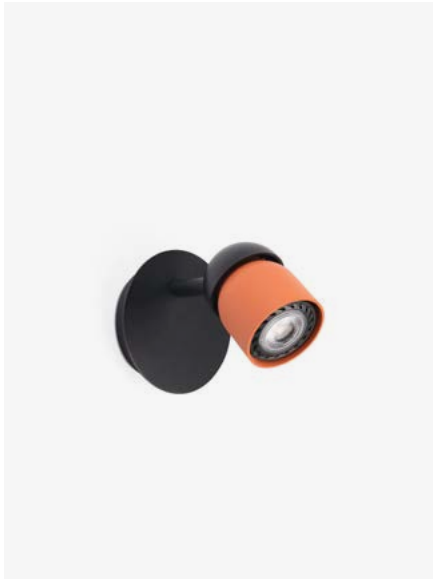

- 40660 Structure Matt White
- 40661 Structure Matt Black
- 40663 Structure Matt Black + Terracotta

Material	Structure ABS + Steel
Light Source	1 GU10 LED max. 8W
Bulb incl.	No
Recom. Bulb	17333
Class	I

Coco 2L
Faro Lab

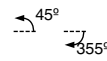

110V Check p. 30



- 40664 Structure Matt White

Material	Structure ABS + Steel
Light Source	2 GU10 LED max. 8W
Bulb incl.	No
Recom. Bulb	17333
Class	I

Coco 3L
Faro Lab

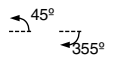

110V Check p. 30



- 40667 Structure Matt Black

Material	Structure ABS + Steel
Light Source	3 GU10 LED max. 8W
Bulb incl.	No
Recom. Bulb	17334
Class	I

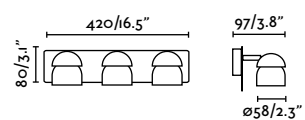
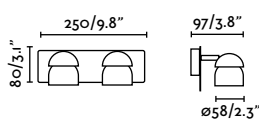
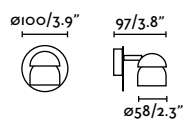

Stone 1L
Àlex & Manel Llusçà

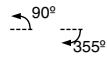

110V Check p. 30



43500 ●● Structure Grey + Matt
Black

Stone 3L
Àlex & Manel Llusçà

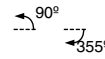

110V Check p. 30



43502 ●● Structure Grey + Matt
Black

Lao Wall 3L
Nahtrang

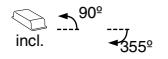

110V Check p. 30



29043 ●● Structure Matt Black +
Gloss Black
● Diffuser Opal

Material	Structure Concrete + Steel
Light Source	1 GU10 LED max. 8W
Bulb incl.	No
Recom. Bulb	17334
Class	I

Material	Structure Concrete + Steel
Light Source	3 GU10 LED max. 8W
Bulb incl.	No
Recom. Bulb	17334
Class	I

Material	Structure Aluminium + ABS
	Diffuser PMMA
Power	3x4W
Lumen Output	3x367lm
Light Source	SMD LED 3000K
Class	I
CRI	>80
Voltage	220V-240V/50/60Hz

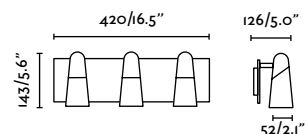
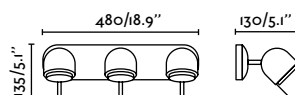
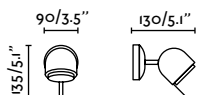

Orleans Wall 2L
Nahtrang

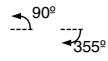

110V Check p. 30



43525 **Structure** Chrome + Matt Black

Orleans Wall 3L
Nahtrang

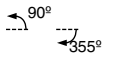

110V Check p. 30



43527 **Structure** Matt Black

43528 **Structure** Chrome + Matt Black

Material	Structure Steel
Light Source	2 GU10 LED max. 8W
Bulb incl.	No
Recom. Bulb	17334
Class	I

Material	Structure Steel
Light Source	3 GU10 LED max. 8W
Bulb incl.	No
Recom. Bulb	17334
Class	I

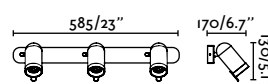
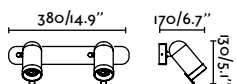



Novo 250
Faro Lab

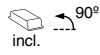

- 62716 ● **Structure** Beige
- 62717 ● **Structure** Matt Black
- 62718 ● **Structure** Terracotta

Material	Structure Steel
Power	5W
Lumen Output	344lm
Light Source	SMD LED 2700K
Class	II
CRI	≥90
Voltage	220V-240V/50/60Hz

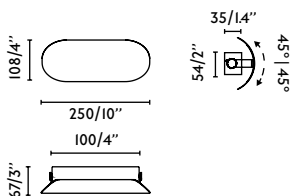

Novo 500
Faro Lab

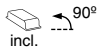

- 62724 ● **Structure** Beige
- 62725 ● **Structure** Matt Black
- 62726 ● **Structure** Terracotta

Material	Structure Steel
Power	12W
Lumen Output	610lm
Light Source	SMD LED 2700K
Class	II
CRI	≥90
Voltage	220V-240V/50/60Hz

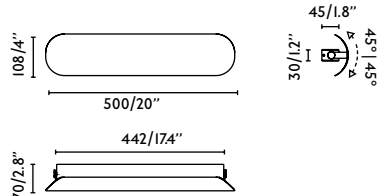



Eres

Àlex & Manel Lluscà

110V Check p. 30

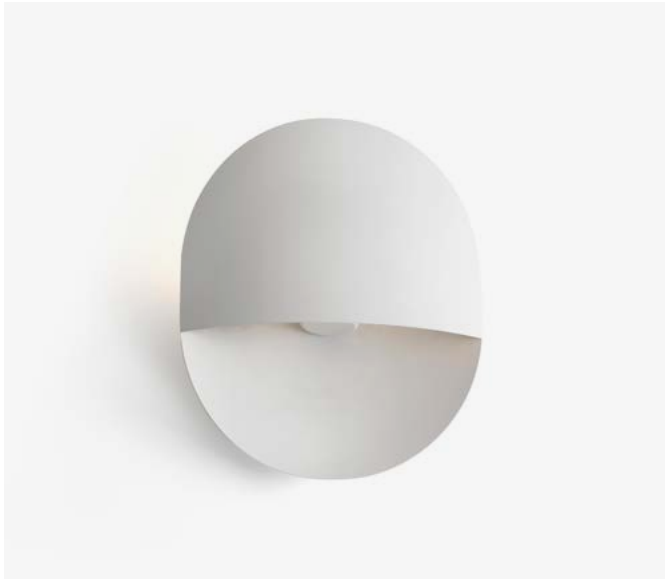

64026

● Structure Matt White

Material	Structure Steel
Light Source	1 E27 LED max. 15W
Bulb incl.	No
Recom. Bulb	17463
Class	I

Homs

40°

110V Check p. 30



63167

● Structure Matt White

Material	Structure Steel
Light Source	1 R7S LED 78mm max. 8W
Bulb incl.	No
Recom. Bulb	17499
Class	I

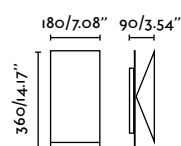
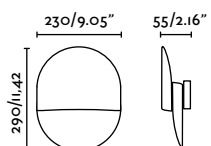



Ovo 190
Estudi Ribaudí



110V Check p. 30



62105 ● Structure Matt White

Material	Structure Steel
Light Source	1 R7S LED 78mm max. 8W
Bulb incl.	No
Recom. Bulb	17499
Class	I

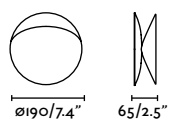

Ovo 240
Estudi Ribaudí



110V Check p. 30



62108 ● Structure Matt White

Material	Structure Steel
Light Source	1 R7S LED 118mm max. 15W
Bulb incl.	No
Recom. Bulb	17497
Class	I

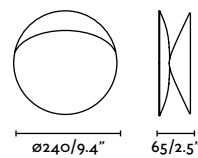

indoor

Wall



Sole & Lune

A great combination of functionality and design in a compact format, perfect for hallways and other small spaces.



Lune 40532





A square and sophisticated design, perfect for hallways and passageways.

Lune 40568

Sole 1L

110V Check p. 30



- 40522 **Structure** White + White
- 40523 **Structure** Black + Black
- 40524 **Structure** Grey + White
- 40525 **Structure** Terracotta + Black

Material	Structure Aluminium + Steel
Light Source	1 GU10 LED max. 8W
Bulb incl.	No
Recom. Bulb	17316
Class	I

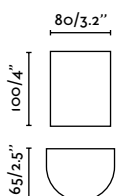

Sole 2L

110V Check p. 30



- 40538 **Structure** White + White
- 40539 **Structure** Black + Black
- 40540 **Structure** Grey + White
- 40541 **Structure** Terracotta + Black

Material	Structure Aluminium + Steel
Light Source	2 GU10 LED max. 8W
Bulb incl.	No
Recom. Bulb	17316
Class	I

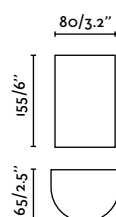

Sole 1L Ribbed

110V Check p. 30



40526	●● Structure White + White
40527	●● Structure Black + Black
40528	●● Structure Grey + White
40529	●● Structure Terracotta + Black

Material	Structure Aluminium + Steel
Light Source	1 GU10 LED max. 8W
Bulb incl.	No
Recom. Bulb	17316
Class	I

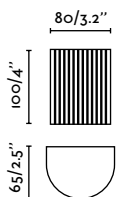

Sole 2L Ribbed

110V Check p. 30



40542	●● Structure White + White
40543	●● Structure Black + Black
40544	●● Structure Grey + White
40545	●● Structure Terracotta + Black

Material	Structure Aluminium + Steel
Light Source	2 GU10 LED max. 8W
Bulb incl.	No
Recom. Bulb	17316
Class	I

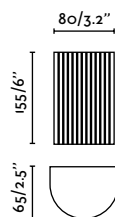

Lune 1L

110V Check p. 30



- 40530 Structure White + White
- 40531 Structure Black + Black
- 40533 Structure Terracotta + Black
- 40532 Structure Grey + White

Material	Structure Aluminium + Steel
Light Source	1 GU10 LED max. 8W
Bulb incl.	No
Recom. Bulb	17316
Class	I

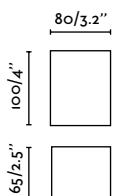

Lune 2L

110V Check p. 30



- 40546 Structure White + White
- 40547 Structure Black + Black
- 40548 Structure Grey + White
- 40549 Structure Terracotta + Black

Material	Structure Aluminium + Steel
Light Source	2 GU10 LED max. 8W
Bulb incl.	No
Recom. Bulb	17316
Class	I

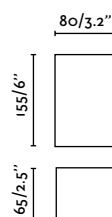

Lune 1L Ribbed

110V Check p. 30



- 40534 Structure White + White
- 40535 Structure Black + Black
- 40536 Structure Grey + White
- 40537 Structure Terracotta + Black

Material	Structure Aluminium + Steel
Light Source	1 GU10 LED max. 8W
Bulb incl.	No
Recom. Bulb	17316
Class	I

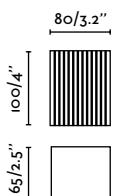

Lune 2L Ribbed

110V Check p. 30



- 40565 Structure White + White
- 40566 Structure Black + Black
- 40567 Structure Grey + White
- 40568 Structure Terracotta + Black

Material	Structure Aluminium + Steel
Light Source	2 GU10 LED max. 8W
Bulb incl.	No
Recom. Bulb	17316
Class	I

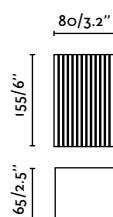

Stan 1L

110V Check p. 30

NEW FINISH



43748	●● Structure Matt White + Matt Black
43749	●● Structure Matt Black + Matt Black
43759	●● Structure Satin Gold + Matt Black
43765	●● Structure Terracotta + Matt Black
43778 NEW	●● Structure Brushed Aluminium + Matt Black

Material	Structure Aluminium + ABS
Light Source	1 GU10 LED max. 5W
Bulb incl.	No
Recom. Bulb	17334
Class	I

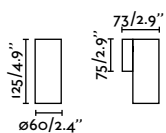

Stan 2L

110V Check p. 30

NEW FINISH



43750	●● Structure Matt White + Matt Black
43751	●● Structure Matt Black + Matt Black
43760	●● Structure Satin Gold + Matt Black
43766	●● Structure Terracotta + Matt Black
43779 NEW	●● Structure Brushed Aluminium + Matt Black

Material	Structure Aluminium + ABS
Light Source	2 GU10 LED max. 5W
Bulb incl.	No
Recom. Bulb	17334
Class	I

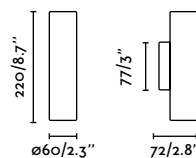

indoor

Wall



Nash 210



- 62819 Structure Matt White
- Diffuser Opal

- 62821 Structure Matt Black
- Diffuser Opal

Material	Structure Aluminium
	Diffuser PC
Power	8W
Lumen Output	509lm
Light Source	SMD LED 3000K
Class	I
CRI	>80
Voltage	220V-240V/50/60Hz

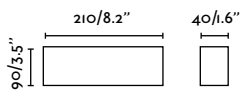

Nash 370



- 62820 Structure Matt White
- Diffuser Opal

- 62822 Structure Matt Black
- Diffuser Opal

Material	Structure Aluminium
	Diffuser PC
Power	16W
Lumen Output	1360lm
Light Source	SMD LED 3000K
Class	I
CRI	>80
Voltage	220V-240V/50/60Hz

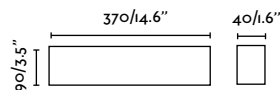

indoor

Wall





Kappu

Designed by Faro Lab

Kappu ('cup' in Japanese) is an allegory to the object that contains light. Its simple, minimalist geometry also allows it to be easily painted to adapt to the needs of any space.



Kappu 63428

Kappu 158
Faro Lab

110V Check p. 30



63428 ● Structure White

Material	Structure Plaster
Light Source	1 E14 LED G45 max. 7W
Bulb incl.	No
Recom. Bulb	17461
Class	II

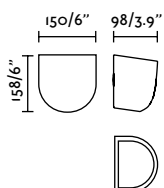

Kappu 250
Faro Lab

110V Check p. 30



63429 ● Structure White

Material	Structure Plaster
Light Source	1 E14 LED G45 max. 7W
Bulb incl.	No
Recom. Bulb	17461
Class	II

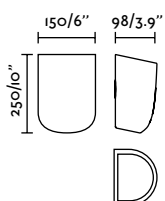

Kappu 300
Faro Lab

110V Check p. 30



63430 ● Structure White

Material	Structure Plaster
Light Source	2 E14 LED G45 max. 7W
Bulb incl.	No
Recom. Bulb	17461
Class	II

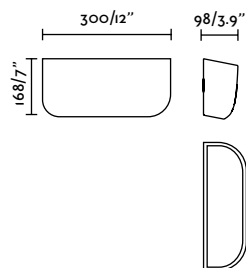

indoor

Wall



Trama

Designed by Faro Lab

Textures are back! Its linear patterns create compositions that break monotony, adding a touch of sophistication and modern style.



Trama 63435



Trama 63435

Trama 180

Faro Lab

110V Check p. 30



63435 ● Structure White

Material	Structure Plaster
Light Source	1 E14 LED G45 max. 7W
Bulb incl.	No
Recom. Bulb	17461
Class	II

Trama 320

Faro Lab

110V Check p. 30



63436 ● Structure White

Material	Structure Plaster
Light Source	2 E14 LED G45 max. 7W
Bulb incl.	No
Recom. Bulb	17461
Class	II

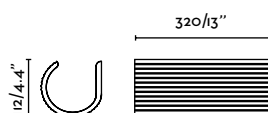
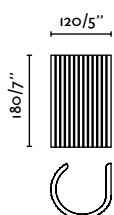



Milo 280
Faro Lab

110V Check p. 30



63420 ● Structure White
● Diffuser Opal

Milo 400
Faro Lab

110V Check p. 30



63421 ● Structure White
● Diffuser Opal

Milo 500
Faro Lab

110V Check p. 30



63422 ● Structure White
● Diffuser Opal

Material	Structure Plaster
	Diffuser PC
Light Source	1 E14 LED C35 max. 7W
Bulb incl.	No
Recom. Bulb	17460
Class	II

Material	Structure Plaster
	Diffuser PC
Light Source	2 E14 LED C35 max. 7W
Bulb incl.	No
Recom. Bulb	17460
Class	II

Material	Structure Plaster
	Diffuser PC
Light Source	2 E14 LED C35 max. 7W
Bulb incl.	No
Recom. Bulb	17460
Class	II

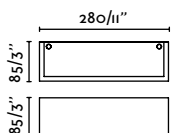

Unidirectional
accessory included

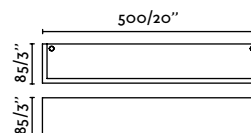
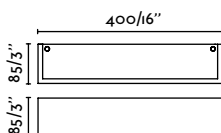

indoor

Wall



Oslo

110V Check p. 30



63284 ● Structure Matt White

Material	Structure Plaster
Light Source	1 G9 LED max. 6W
Bulb incl.	No
Recom. Bulb	17466
Class	I

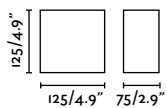

Olaf

110V Check p. 30



63278 ● Structure Matt White
● Diffuser Opal

Material	Structure Plaster
	Diffuser PC
Light Source	2 E14 LED max. 8W
Bulb incl.	No
Recom. Bulb	17461
Class	I

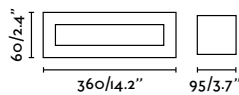



Cheras 2

110V Check p. 30



63173 ● Structure Matt White
● Diffuser Opal

Material	Structure Plaster
	Diffuser Glass
Light Source	1 R7S LED 78mm max. 8W
Bulb incl.	No
Recom. Bulb	17499
Class	I

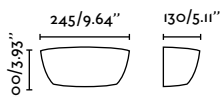

Cheras 3

110V Check p. 30



63174 ● Structure Matt White
● Diffuser Opal

Material	Structure Plaster
	Diffuser Glass
Light Source	1 G9 LED max. 6W
Bulb incl.	No
Recom. Bulb	17466
Class	I

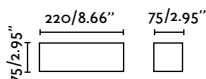

Cheras 4

110V Check p. 30



63175 ● Structure Matt White
● Diffuser Opal

Material	Structure Plaster
	Diffuser Glass
Light Source	1 R7S LED 78mm max. 8W
Bulb incl.	No
Recom. Bulb	17499
Class	I

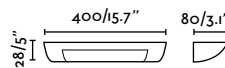

indoor

Wall



Eaco 1

110V Check p. 30



63176 ● Structure Matt White

Material	Structure Plaster
Light Source	1 G9 LED max. 6W
Bulb incl.	No
Recom. Bulb	17466
Class	I

Eaco 2

110V Check p. 30



63177 ● Structure Matt White

Material	Structure Plaster
Light Source	2 G9 LED max. 6W
Bulb incl.	No
Recom. Bulb	17466
Class	I

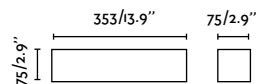
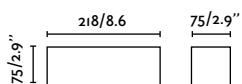

indoor

Wall



Snow

110V Check p. 30



63285 ● Structure Matt White

Material	Structure Plaster
Light Source	1 E14 LED max. 8W
Bulb incl.	No
Recom. Bulb	17461
Class	I

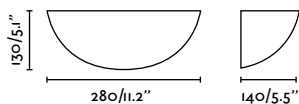

Elsa

110V Check p. 30



63279 ● Structure Matt White
● Diffuser Opal

Material	Structure Plaster
	Diffuser PC
Power	8W
Lumen Output	405lm
Light Source	SMD LED 3000K
Class	II
CRI	>80
Voltage	220V-240V/50/60Hz



Cove

incl.



63480 ● Structure White

Material	Structure Plaster
Power	4W
Lumen Output	187lm
Light Source	SMD LED 3000K
Class	I
CRI	>80
Voltage	220V-240V/50/60Hz

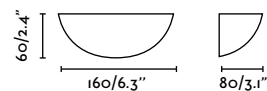



Tera



Luna



Kamen



63184 ● Structure Matt White

110V Check p. 30



63225 ● Structure Matt White
● Diffuser Opal

110V Check p. 30



63311 ● Structure Beige
63312 ● Structure Grey

Material	Structure Plaster
Power	6W
Lumen Output	491lm
Light Source	SMD LED 2700K
Class	II
CRI	>80
Voltage	220V-240V/50/60Hz

Material	Structure Plaster
	Diffuser PMMA
Power	5W
Lumen Output	356lm
Light Source	SMD LED 2700K
Class	II
CRI	>80
Voltage	220V-240V/50/60Hz

Material	Structure Concrete
Light Source	1 G9 LED max. 6W
Bulb incl.	No
Recom. Bulb	17466
Class	I

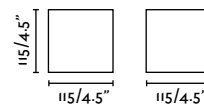
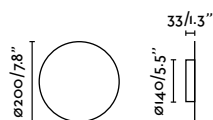
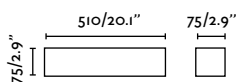



Otton RCT Vertical

110V Check p. 30



66400-97 ● Structure Matt White
● Shade Beige Linen

66400-98 ● Structure Matt White
● Shade Brown Jute

Material	Structure Steel
	Shade Textile
Light Source	1 E27 LED max. 15W
Bulb incl.	No
Recom. Bulb	17463
Class	I

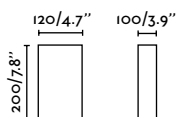

Otton R Vertical

110V Check p. 30



66400-101 ● Structure Matt White
● Shade Beige Linen

66400-102 ● Structure Matt White
● Shade Brown Jute

Material	Structure Steel
	Shade Textile
Light Source	1 E27 LED max. 15W
Bulb incl.	No
Recom. Bulb	17463
Class	I

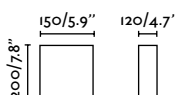

Otton SQ 200

110V Check p. 30



66400-105 ● Structure Matt White
● Shade Beige Linen

66400-106 ● Structure Matt White
● Shade Brown Jute

Material	Structure Steel
	Shade Textile
Light Source	1 E27 LED max. 15W
Bulb incl.	No
Recom. Bulb	17463
Class	I

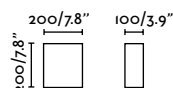



Otton RCT Vertical 2L

110V Check p. 30



- 66401-99 Structure Matt White
- Shade Beige Linen

- 66401-100 Structure Matt White
- Shade Brown Jute

Material	Structure Steel
	Shade Textile
Light Source	2 E27 LED max. 15W
Bulb incl.	No
Recom. Bulb	17463
Class	I

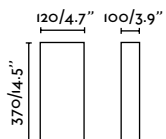

Otton R Vertical 2L

110V Check p. 30



- 66401-103 Structure Matt White
- Shade Beige Linen

- 66401-104 Structure Matt White
- Shade Brown Jute

Material	Structure Steel
	Shade Textile
Light Source	2 E27 LED max. 15W
Bulb incl.	No
Recom. Bulb	17463
Class	I



Otton RCT Horizontal 2L

110V Check p. 30



66401-107 ● Structure Matt White
● Shade Beige Linen

66401-108 ● Structure Matt White
● Shade Brown Jute

Material	Structure Steel
	Shade Textile
Light Source	2 E27 LED max. 15W
Bulb incl.	No
Recom. Bulb	17463
Class	I

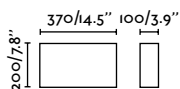

Otton R Horizontal 2L

110V Check p. 30



66401-109 ● Structure Matt White
● Shade Beige Linen

66401-110 ● Structure Matt White
● Shade Brown Jute

Material	Structure Steel
	Shade Textile
Light Source	2 E27 LED max. 15W
Bulb incl.	No
Recom. Bulb	17463
Class	I

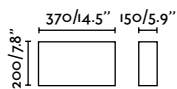

Cotton RCT Vertical 2L

110V Check p. 30



66405 ● Structure Matt White
● Shade Beige

66406 ● Structure Matt White
● Shade Black

Material	Structure Steel
	Shade Textile
Light Source	2 E27 LED max. 15W
Bulb incl.	No
Recom. Bulb	17463
Class	I

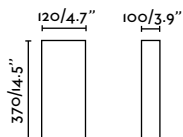

Cotton R Vertical

110V Check p. 30



66407 ● Structure Matt White
● Shade Beige

66408 ● Structure Matt White
● Shade Black

Material	Structure Steel
	Shade Textile
Light Source	1 E27 LED max. 15W
Bulb incl.	No
Recom. Bulb	17463
Class	I

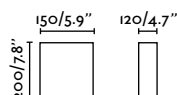

Cotton R Vertical 2L

110V Check p. 30



66409 ● Structure Matt White
● Shade Beige

66410 ● Structure Matt White
● Shade Black

Material	Structure Steel
	Shade Textile
Light Source	2 E27 LED max. 15W
Bulb incl.	No
Recom. Bulb	17463
Class	I

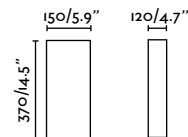

indoor

Wall



Cotton RCT Vertical

110V Check p. 30



66403 ● Structure Matt White
● Shade Beige

66404 ● Structure Matt White
● Shade Black

Material	Structure Steel
	Shade Textile
Light Source	1 E27 LED max. 15W
Bulb incl.	No
Recom. Bulb	17463
Class	I

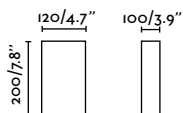

Cotton SQ 200

110V Check p. 30



66411 ● Structure Matt White
● Shade Beige

66412 ● Structure Matt White
● Shade Black

Material	Structure Steel
	Shade Textile
Light Source	1 E27 LED max. 15W
Bulb incl.	No
Recom. Bulb	17463
Class	I

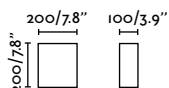

Cotton RCT Horizontal 2L

110V Check p. 30



- 66413 **Structure** Matt White
- Shade** Beige

- 66414 **Structure** Matt White
- Shade** Black

Material	Structure Steel
	Shade Textile
Light Source	2 E27 LED max. 15W
Bulb incl.	No
Recom. Bulb	17463
Class	I

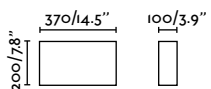

Cotton R Horizontal 2L

110V Check p. 30



- 66415 **Structure** Matt White
- Shade** Beige

- 66416 **Structure** Matt White
- Shade** Black

Material	Structure Steel
	Shade Textile
Light Source	2 E27 LED max. 15W
Bulb incl.	No
Recom. Bulb	17463
Class	I

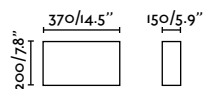

Stood Wall
Lucid Product Design



29844 ● **Structure** Matt Black
● **Shade** Cherry Wood

Material	Structure Steel
	Shade Cherry Wood
Light Source	1 E27 LED max. 15W
Bulb incl.	No
Recom. Bulb	17462
Class	II

Linda Wall
Estudi Ribaudí



29306 ● **Structure** Matt White
● **Shade** Beige

29310 ● **Structure** Matt Black
● **Shade** Beige

Material	Structure Steel
	Shade Textile
Light Source	2 E27 LED max. 15W
Bulb incl.	No
Recom. Bulb	17463
Class	I

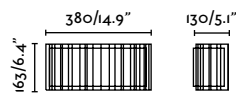
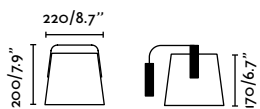
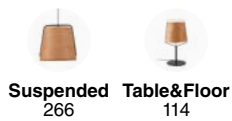



Diula 2L

110V Check p. 30



62986 ● Structure Satin Nickel
● Diffuser Opal

Material	Structure Steel
	Diffuser Glass
Light Source	2 E27 LED max. 15W
Bulb incl.	No
Recom. Bulb	17463
Class	I

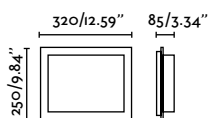

Diula 1L

110V Check p. 30



62987 ● Structure Satin Nickel
● Diffuser Opal

Material	Structure Steel
	Diffuser Glass
Light Source	1 E27 LED max. 15W
Bulb incl.	No
Recom. Bulb	17463
Class	I

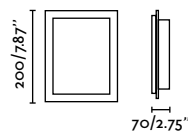



Confetti 300 H70

Nutcreatives

110V Check p. 30



62173-50 ● Structure Matt Black
 ☼ Shade White & Black

62174-50 ● Structure Matt Black
 ☼ Shade White & Black

Material	Structure Aluminium
	Shade Recycled PET
Light Source	1 E27 LED max. 15W
Bulb incl.	No
Recom. Bulb	17463
Class	II

Confetti 450 H70

Nutcreatives

110V Check p. 30



62173-51 ● Structure Matt Black
 ☼ Shade White & Black

62174-51 ● Structure Matt Black
 ☼ Shade White & Black

Material	Structure Aluminium
	Shade Recycled PET
Light Source	1 E27 LED max. 15W
Bulb incl.	No
Recom. Bulb	17464
Class	II



Suspended
244

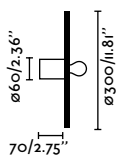

62173-50

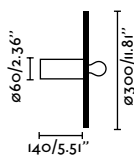

62174-50



Double position

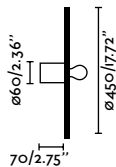

62173-51

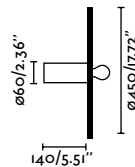

62174-51



Double position



Locally produced, made from recycled plastic from bottle caps.

Costas 400 H70
Àlex & Manel Llusçà

110V Check p. 30



- 62173-78 ● Structure Matt Black
● Shade Rattan
- 62174-78 ● Structure Matt Black
● Shade Rattan

Material	Structure Aluminium
	Shade Rattan
Light Source	1 E27 LED max. 15W
Bulb incl.	No
Recom. Bulb	17071
Class	II

Costas 600 H70
Àlex & Manel Llusçà

110V Check p. 30

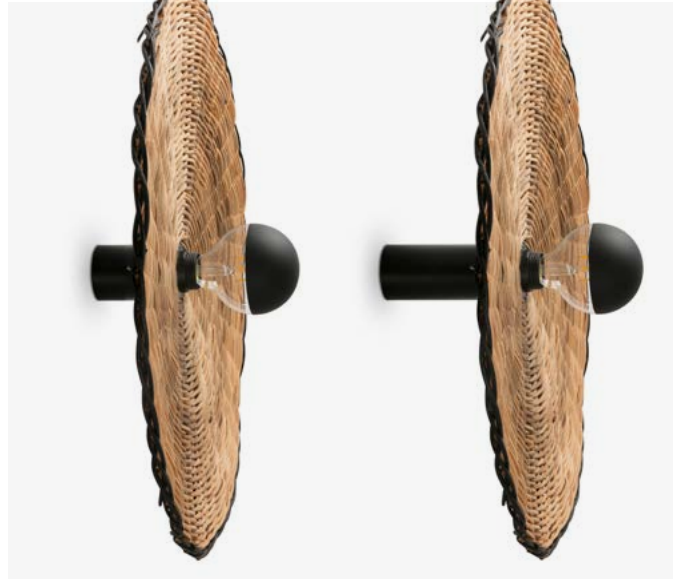

- 62173-69 ● Structure Matt Black
● Shade Rattan
- 62174-69 ● Structure Matt Black
● Shade Rattan

Material	Structure Aluminium
	Shade Rattan
Light Source	1 E27 LED max. 15W
Bulb incl.	No
Recom. Bulb	17072E
Class	II



Suspended
246

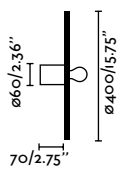

62173-78

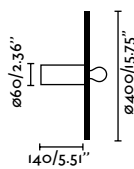

62174-78



Double position

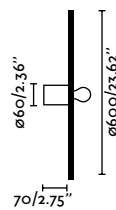

62173-69

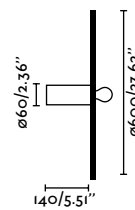

62174-69



Double position





It brings a Mediterranean touch to the space where you place it.

Isabelle 150
Héctor Serrano

IP44  incl.



28299  Structure Matt White
 Diffuser Opal



Material	Structure Aluminium
	Diffuser Glass
Power	7,8W
Lumen Output	362lm
Light Source	SMD LED 2700K
Class	II
CRI	90
Voltage	220V-240V/50/60Hz
Beam angle	135°



Suspended
196

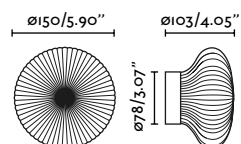



110V  Check p. 30



40095	● Structure White ● Diffuser Opal
40096	● Structure Black ● Diffuser Opal
40097	● Structure Blue ● Diffuser Opal
40098	● Structure Coral ● Diffuser Opal
40099	● Structure Green ● Diffuser Opal

Material	Structure Steel Diffuser Glass
Power	4W
Lumen Output	238lm
Light Source	COB LED 2700K
Class	II
Voltage	100V-240V/50/60Hz

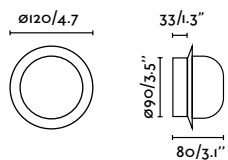

indoor

Wall







Moy
Nahtrng

IP44  incl.

110V Check p. 30



- 40090  **Structure** Satin Gold
 **Diffuser** Opal
- 40091  **Structure** Chrome
 **Diffuser** Opal
- 40092  **Structure** Bronze
 **Diffuser** Opal
- 40093  **Structure** Matt Black
 **Diffuser** Opal

Material	Structure Steel
	Diffuser Glass
Power	4W
Lumen Output	260lm
Light Source	SMD LED 3000K
Class	II
CRI	>80
Voltage	100V-240V/50/60Hz

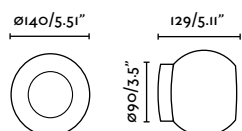

Le Vita Wall
Nahtrng

 incl.



- 29690  **Structure** Gloss Gold
 **Diffuser** Opal
- 29695  **Structure** Matt Black
 **Diffuser** Opal

Material	Structure Steel
	Diffuser Glass
Power	7W
Lumen Output	694lm
Light Source	SMD LED 2700K
Class	I
CRI	>80
Voltage	100V-240V/50/60Hz

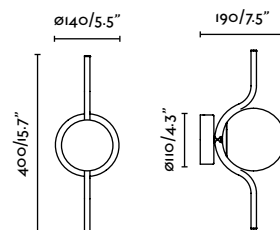
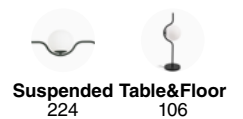

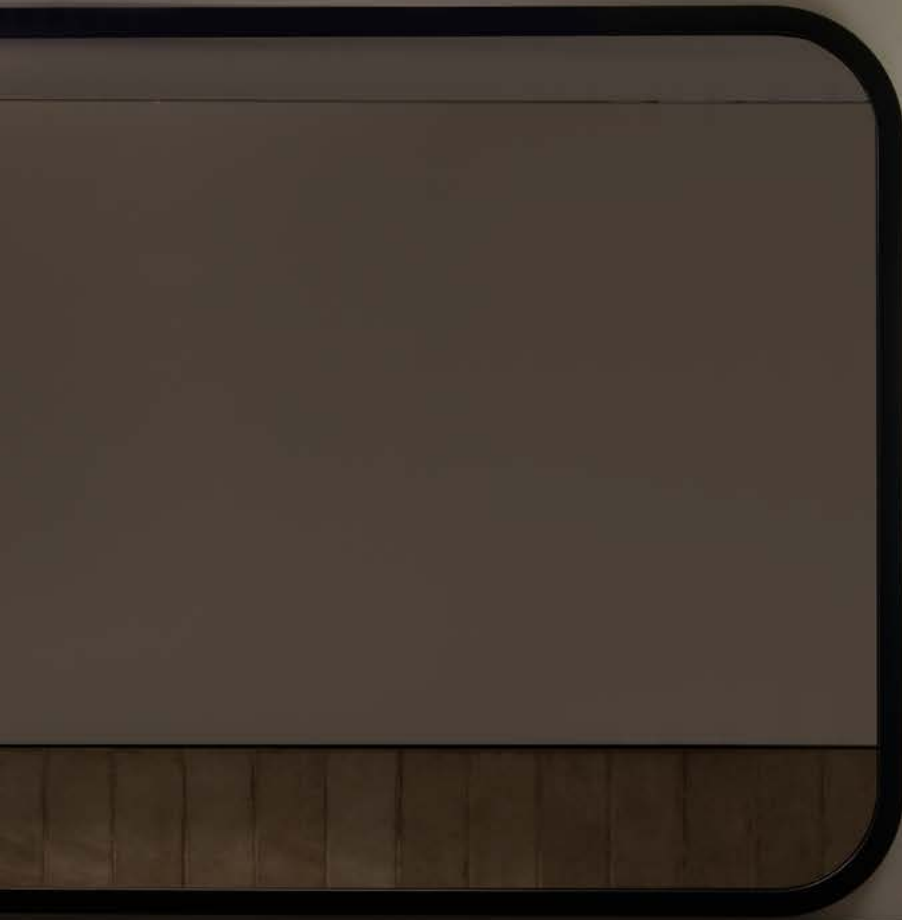

Ten 140 Wall

Faro Lab

110V Check p. 30



- 62170 Structure Matt White
- 62171 Structure Matt Black
- 62172 Structure Old Gold

Material	Structure Aluminium
Light Source	1 E27 LED max. 15W
Bulb incl.	No
Recom. Bulb	17464
Class	II

Ten 70 Wall

Faro Lab

110V Check p. 30



- 62150 Structure Matt White
- 62151 Structure Matt Black
- 62152 Structure Old Gold
- 62153 Structure Satin Gold
- 62154 Structure Gloss Copper
- 62155 Structure Satin Nickel

Material	Structure Aluminium
Light Source	1 E27 LED max. 15W
Bulb incl.	No
Recom. Bulb	17464
Class	II



Table 52

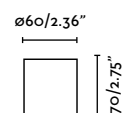
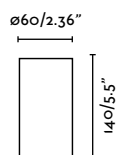



Joy Nahrang



110V Check p. 30



64027 ● Structure Matt Black
● Diffuser Opal

Kera

110V Check p. 30



62300 ● Structure Gloss White
62301 ● Structure Gloss Black

Sera

110V Check p. 30



62302 ● Structure Gloss White
62303 ● Structure Gloss Black

Material	Structure Aluminium
	Diffuser Glass
Power	3W
Lumen Output	276lm
Light Source	SMD LED 3000K
Class	I
CRI	>80
Voltage	100V-240V/50/60Hz

Material	Structure Ceramic
Light Source	1 E27 LED max. 15W
Bulb incl.	No
Recom. Bulb	17464
Class	II

Material	Structure Ceramic
Light Source	1 E27 LED max. 15W
Bulb incl.	No
Recom. Bulb	17464
Class	II

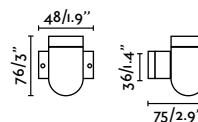
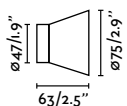
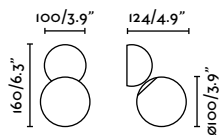



Board 350



incl.

110V Check p. 30



01040 ● Structure Blackboard
● Diffuser Opal

Material	Structure Steel
	Diffuser PMMA
Power	8W
Lumen Output	191lm
Light Source	SMD LED 2700K
Class	I
CRI	>80
Voltage	220V-240V/50/60Hz

Board 450



incl.



01041 ● Structure Blackboard
● Diffuser Opal

Material	Structure Steel
	Diffuser PMMA
Power	12W
Lumen Output	386lm
Light Source	SMD LED 2700K
Class	I
CRI	>80
Voltage	220V-240V/50/60Hz

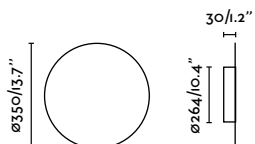

Blackboard

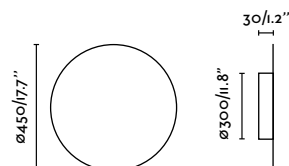



Han
Goula / Figuera

incl.

110V Check p. 30

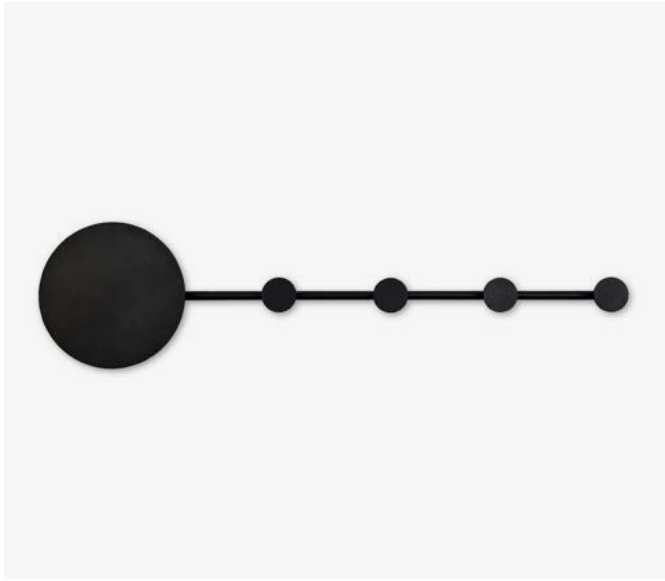

01001 ● Structure Matt Black
● Diffuser Opal

Material	Structure Steel
	Diffuser PMMA
Power	7W
Lumen Output	258lm
Light Source	SMD LED 2700K
Class	I
CRI	>80
Voltage	220V-240V/50/60Hz

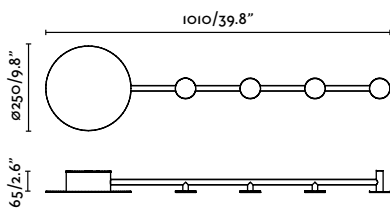



Magritte 300

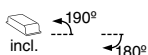

- 61080 Structure Satin Nickel
 Diffuser Opal
- 61083 Structure Old Gold
 Diffuser Opal
- 61086 Structure Matt Black
 Diffuser Opal

Material	Structure Aluminium + Steel Diffuser PMMA
Power	6W
Lumen Output	325lm
Light Source	SMD LED 3000K
Class	II
CRI	>80
Voltage	220V-240V/50/60Hz

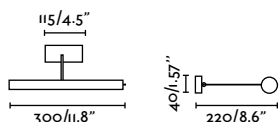

Magritte 450



110V Check p. 30



- 61081 Structure Satin Nickel
 Diffuser Opal
- 61084 Structure Old Gold
 Diffuser Opal
- 61087 Structure Matt Black
 Diffuser Opal

Material	Structure Aluminium + Steel Diffuser PMMA
Power	8W
Lumen Output	402lm
Light Source	SMD LED 3000K
Class	II
CRI	>80
Voltage	220V-240V/50/60Hz

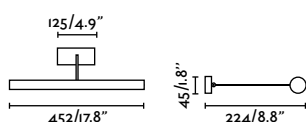

Magritte 600

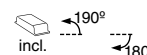

110V Check p. 30



- 61082 Structure Satin Nickel
 Diffuser Opal
- 61085 Structure Old Gold
 Diffuser Opal
- 61088 Structure Matt Black
 Diffuser Opal

Material	Structure Aluminium + Steel Diffuser PMMA
Power	12W
Lumen Output	727lm
Light Source	SMD LED 3000K
Class	II
CRI	>80
Voltage	220V-240V/50/60Hz

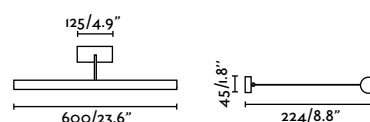



Nubo 120

IP44  incl.



- 60006 Structure Matt White
- Diffuser Opal

- 60007 Structure Matt Black
- Diffuser Opal

Material	Structure Aluminium
	Diffuser Glass
Power	7,8W
Lumen Output	362lm
Light Source	SMD LED 2700K
Class	II
CRI	90
Voltage	220V-240V/50/60Hz

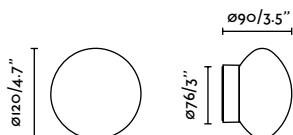

Nubo 150

IP44  incl.



- 60008 Structure Matt White
- Diffuser Opal

- 60009 Structure Matt Black
- Diffuser Opal

Material	Structure Aluminium
	Diffuser Glass
Power	9,7W
Lumen Output	821lm
Light Source	SMD LED 2700K
Class	II
CRI	90
Voltage	220V-240V/50/60Hz

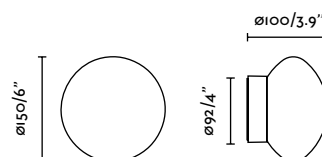



Ideal for bathrooms, Nubo's opal diffuser softens the light, creating a comfortable, glare-free illumination. Its smooth, flowing shapes add an elegant and calming touch to any space.

Mabe

IP44



Perla
Àlex & Manel Llusçà

IP44

110V Check p. 30



- 62830 ● Structure Matt Black
● Diffuser Opal
- 62831 ● Structure Matt Nickel
● Diffuser Opal



- 40085 ● Structure Old Gold
● Diffuser Opal
- 40086 ● Structure Chrome
● Diffuser Opal
- 40087 ● Structure Bronze
● Diffuser Opal
- 40088 ● Structure Black
● Diffuser Opal

Material	Structure Stainless Steel
	Diffuser Glass
Power	6W
Lumen Output	503lm
Light Source	SMD LED 3000K
Class	II
CRI	>80
Voltage	220V-240V/50/60Hz

Material	Structure Steel
	Diffuser Glass
Light Source	1 G9 LED max. 6W
Bulb incl.	No
Recom. Bulb	17443
Class	II

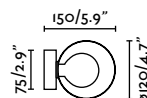
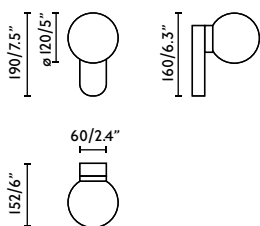



Lago

IP44

110V Check p. 30



63503 **Structure** Chrome
● **Diffuser** Opal

Material	Structure Aluminium
	Diffuser Glass
Light Source	1 G9 LED max. 6W
Bulb incl.	No
Recom. Bulb	17495
Class	II

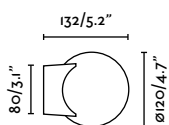

Ping

IP44  incl.



60010 ● **Structure** Matt White
● **Diffuser** Opal
60011 ● **Structure** Matt Black
● **Diffuser** Opal

Material	Structure Aluminium
	Diffuser Glass
Power	7,8W
Lumen Output	756lm
Light Source	SMD LED 3000K
Class	II
CRI	90
Voltage	220V-240V/50/60Hz

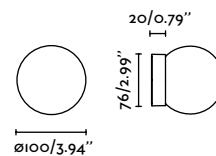

indoor

Wall



Gala

IP44

110V Check p. 30



- 63504 Structure Chrome
 Diffuser Opal
- 63505 Structure Satin Gold
 Diffuser Opal
- 63506 Structure Matt Black
 Diffuser Opal

Material	Structure Aluminium
	Diffuser Glass
Light Source	1 G9 LED max. 6W
Bulb incl.	No
Recom. Bulb	17495
Class	II

Bianca Àlex & Manel Llusçà

IP44

110V Check p. 30



- 63510 Structure Chrome
 Diffuser Opal

Material	Structure Aluminium
	Diffuser Glass
Light Source	1 G9 LED max. 6W
Bulb incl.	No
Recom. Bulb	17443
Class	II

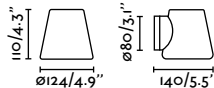

Brume Wall Àlex & Manel Llusçà

IP44



110V Check p. 30



- 40076 Structure Anthracite
 Diffuser Opal

Material	Structure Steel
	Diffuser Glass
Power	3W
Lumen Output	168lm
Light Source	SMD LED 2700K
Class	II
CRI	>80
Voltage	100V-240V/50/60Hz

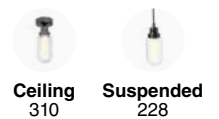
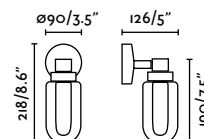

indoor

Wall



Calma 300

IP44



63546		Structure White + Opal
63547		Structure Black + Opal
63548		Structure Brushed Gold + Opal
63549		Structure Yellow + Opal
63550		Structure Blue + Opal
63551		Structure Terracotta + Opal
63558		Structure Wood + Opal

Material	Structure Glass
Power	5W
Lumen Output	430lm
Light Source	S14D LED 2700K
Class	II
CRI	>80
Voltage	220V-240V/50/60Hz

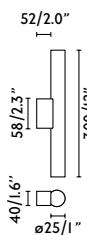

Calma 500

IP44



63552		Structure White + Opal
63553		Structure Black + Opal
63554		Structure Brushed Gold + Opal
63555		Structure Yellow + Opal
63556		Structure Blue + Opal
63557		Structure Terracotta + Opal
63559		Structure Wood + Opal

Material	Structure Glass
Power	7W
Lumen Output	608lm
Light Source	S14D LED 2700K
Class	II
CRI	>80
Voltage	220V-240V/50/60Hz

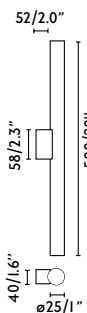



Tide 300

IP44  incl.



- 63520 Structure Matt Black
- Diffuser Opal

- 63521 Structure Chrome
- Diffuser Opal

Material	Structure Aluminium
	Diffuser PMMA
Power	6W
Lumen Output	628lm
Light Source	SMD LED 3000K
Class	II
CRI	≥80
Voltage	220V-240V/50/60Hz

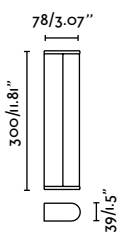

Tide 600

IP44  incl.



- 63522 Structure Matt Black
- Diffuser Opal

- 63523 Structure Chrome
- Diffuser Opal

Material	Structure Aluminium
	Diffuser PMMA
Power	9W
Lumen Output	1049lm
Light Source	SMD LED 3000K
Class	II
CRI	≥80
Voltage	220V-240V/50/60Hz

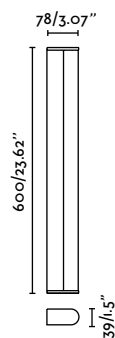







Volga 310

IP44  incl.

110V  Check p. 30







- 63507  Structure Chrome
-  Diffuser Opal
- 63512  Structure Matt Black
-  Diffuser Opal

Volga 600

IP44  incl.

110V  Check p. 30







- 63508  Structure Chrome
-  Diffuser Opal
- 63513  Structure Matt Black
-  Diffuser Opal

Volga 900

IP44  incl.

110V  Check p. 30



- 63509  Structure Chrome
-  Diffuser Opal
- 63514  Structure Matt Black
-  Diffuser Opal

Material	Structure Aluminium
	Diffuser PMMA
Power	5W
Lumen Output	469lm
Light Source	SMD LED 3000K
Class	II
CRI	>80
Voltage	100V-240V/50/60Hz

Material	Structure Aluminium
	Diffuser PMMA
Power	12W
Lumen Output	1231lm
Light Source	SMD LED 3000K
Class	II
CRI	>80
Voltage	100V-240V/50/60Hz

Material	Structure Aluminium
	Diffuser PMMA
Power	18W
Lumen Output	1930lm
Light Source	SMD LED 3000K
Class	II
CRI	>80
Voltage	100V-240V/50/60Hz

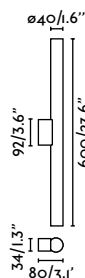
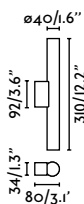

indoor

Wall







Volga 63512

541

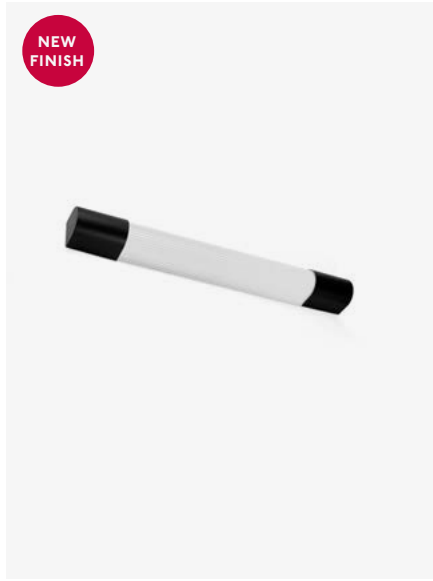
Kiva 600

IP44  incl.







- 62832**  **Structure Chrome**
3000K
1103lm
-  **Shade Translucent**
- 62833**  **Structure Matt Black**
2700K
1068lm
-  **Shade Translucent**

Kiva 900

IP44  incl.







- 62834**  **Structure Chrome**
3000K
1581lm
-  **Shade Translucent**
- 62835**  **Structure Matt Black**
2700K
1530lm
-  **Shade Translucent**

Kiva 1200

IP44  incl.



- 62836**  **Structure Chrome**
3000K
1852lm
-  **Shade Translucent**
- 62837**  **Structure Matt Black**
2700K
1792lm
-  **Shade Translucent**

Material	Structure Stainless Steel
	Shade PMMA
Power	10W
Light Source	SMD LED
Class	II
CRI	>80
Voltage (V/Hz)	220V-240V/50/60Hz

Material	Structure Stainless Steel
	Shade PMMA
Power	14W
Light Source	SMD LED
Class	II
CRI	>80
Voltage (V/Hz)	220V-240V/50/60Hz

Material	Structure Stainless Steel
	Shade PMMA
Power	18W
Light Source	SMD LED
Class	II
CRI	>80
Voltage (V/Hz)	220V-240V/50/60Hz

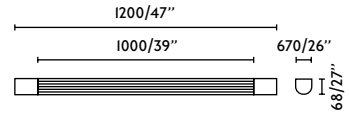
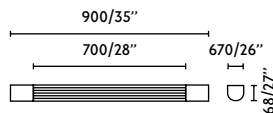
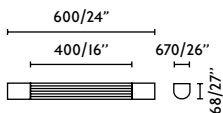

indoor





Wall



Danubio 285

IP44  incl.



- 63600  **Structure** Chrome
 **Diffuser** Opal
- 63603  **Structure** Bronze
 **Diffuser** Opal



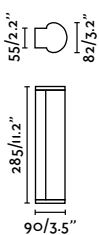

Material	Structure Aluminium Diffuser Glass
Power	9W
Lumen Output	579lm
Light Source	SMD LED 2700K
Class	II
CRI	>80
Voltage	220V-240V/50/60Hz



Danubio 395

IP44  incl.



- 63601  **Structure** Chrome
 **Diffuser** Opal
- 63604  **Structure** Bronze
 **Diffuser** Opal



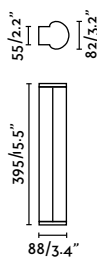

Material	Structure Aluminium Diffuser Glass
Power	12W
Lumen Output	780lm
Light Source	SMD LED 2700K
Class	II
CRI	>80
Voltage	220V-240V/50/60Hz



Danubio 575

IP44  incl.



- 63602  **Structure** Chrome
 **Diffuser** Opal
- 63605  **Structure** Bronze
 **Diffuser** Opal

Material	Structure Aluminium Diffuser Glass
Power	18W
Lumen Output	1368lm
Light Source	SMD LED 2700K
Class	II
CRI	>80
Voltage	220V-240V/50/60Hz

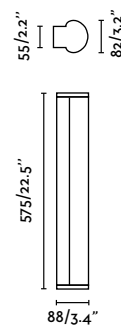







Nilo 600

IP44  incl.

110V  Check p. 30



- 63316  **Structure** Matt Black
 **Diffuser** Opal
- 63318  **Structure** Chrome
 **Diffuser** Opal

Material	Structure Aluminium Diffuser PMMA
Power	12W
Lumen Output	845lm
Light Source	SMD LED 3000K
Class	II
CRI	>80
Voltage	100V-240V/50/60Hz

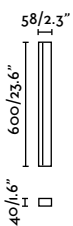





Nilo 900

IP44  incl.

110V  Check p. 30



- 63317  **Structure** Matt Black
 **Diffuser** Opal
- 63319  **Structure** Chrome
 **Diffuser** Opal

Material	Structure Aluminium Diffuser PMMA
Power	18W
Lumen Output	1351lm
Light Source	SMD LED 3000K
Class	II
CRI	>80
Voltage	100V-240V/50/60Hz







INDOOR

LIGHTING

RECESSED



- 43880 ● Structure White
2700K 473lm
- 43881 ● Structure Black
2700K 473lm
- 43882 ● Structure White
3000K 487lm
- 43883 ● Structure Black
3000K 487lm

Material	Structure Aluminium + PC
Power	9W
Light Source	COB LED
Class	III
CRI	80
Voltage	36V/50/60Hz
Beam angle	36°
Cut out	ø55mm

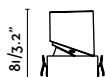

*Drivers info on page 614



- 43884 ● Structure White
2700K 473lm
- 43885 ● Structure Black
2700K 473lm
- 43886 ● Structure White
3000K 487lm
- 43887 ● Structure Black
3000K 487lm

Material	Structure Aluminium + PC
Power	9W
Light Source	COB LED
Class	III
CRI	80
Voltage	36V/50/60Hz
Beam angle	36°
Cut out	ø55mm



*Drivers info on page 614



Fox 40

no incl. DIM

110V Check p. 30



- 02101001 Structure Matt White
- Diffuser Transparent

- 02101002 Structure Matt Black
- Diffuser Transparent

Material	Structure Aluminium
	Diffuser Glass
Power	5W
Lumen Output	242lm
Light Source	COB LED 2700K
Class	III
CRI	90
Beam angle	25°
Cut out	ø35mm

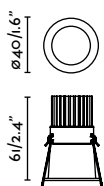

*Drivers info on page 614

Fox Trimless

no incl. DIM

110V Check p. 30



- 02101101 Structure Matt White
- Diffuser Transparent

- 02101102 Structure Matt Black
- Diffuser Transparent

Material	Structure Aluminium
	Diffuser Glass
Power	5W
Lumen Output	301lm
Light Source	COB LED 2700K
Class	III
CRI	90
Beam angle	25°
Cut out	ø45mm

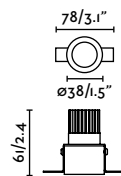

*Drivers info on page 614



Fox 50 Orientable

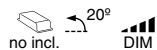

110V Check p. 30



- 02101301 Structure Matt White Diffuser Transparent
- 02101302 Structure Matt Black Diffuser Transparent

Material	Structure Aluminium Diffuser Glass
Power	5W
Lumen Output	344lm
Light Source	COB LED 2700K
Class	III
CRI	>80
Beam angle	25°
Cut out	ø45mm

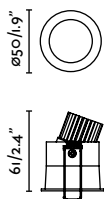

*Drivers info on page 614

Fox 50

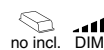

110V Check p. 30



- 02101501 Structure Matt White Diffuser Transparent

Material	Structure Aluminium Diffuser Glass
Power	7W
Lumen Output	479lm
Light Source	COB LED 2700K
Class	III
CRI	>80
Beam angle	36°
Cut out	ø40mm

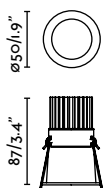

*Drivers info on page 614

Fox 65

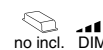

110V Check p. 30



- 02101601 Structure Matt White Diffuser Transparent

Material	Structure Aluminium Diffuser Glass
Power	10W
Lumen Output	777lm
Light Source	COB LED 2700K
Class	III
CRI	>80
Beam angle	36°
Cut out	ø55mm

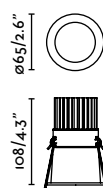

*Drivers info on page 614



Tast R

IP65  incl.



44001 ● Structure Matt White

Material	Structure Aluminium
Power	5W
Lumen Output	350lm
Light Source	COB LED 2700K
Class	II
CRI	≥90
Voltage	220V-240V/50/60Hz
Beam angle	40°
Cut out	ø45mm

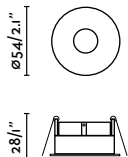

Tast SQ

IP65  incl.



44002 ● Structure Matt White

Material	Structure Aluminium
Power	5W
Lumen Output	350lm
Light Source	COB LED 2700K
Class	II
CRI	≥90
Voltage	220V-240V/50/60Hz
Beam angle	40°
Cut out	ø45mm

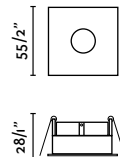

indoor

Recessed



Kivi 52 Orientable

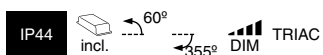

43901 2700K 260lm	● Structure White ● Diffuser Transparent
43902 2700K 231lm	● Structure Black ● Diffuser Transparent
43905 3000K 310lm	● Structure White ● Diffuser Transparent
43906 3000K 307lm	● Structure Black ● Diffuser Transparent

Material	Structure Aluminium Diffuser PC
Power	5W
Light Source	COB LED
Class	II
CRI	90
Voltage	220V-240V/50/60Hz
Beam angle	36°
Cut out	50mm

Kivi 52 Orientable

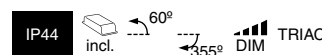

43903 2700K 310lm	● Structure White ● Diffuser Transparent
43904 2700K 307lm	● Structure Black ● Diffuser Transparent
43907 3000K 319lm	● Structure White ● Diffuser Transparent
43908 3000K 316lm	● Structure Black ● Diffuser Transparent

Material	Structure Aluminium Diffuser PC
Power	7W
Light Source	COB LED
Class	II
CRI	90
Voltage	220V-240V/50/60Hz
Beam angle	36°
Cut out	60mm



Without Honeycomb

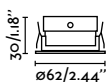

Without Honeycomb

indoor

Recessed



Nais Orientable

IP23 no incl. 25°

110V Check p. 30



- 02111001 Structure White
 Diffuser Transparent
- 02111002 Structure Black
 Diffuser Transparent

Material	Structure Aluminium + Steel
	Diffuser PMMA
Power	7W
Lumen Output	559lm
Light Source	COB LED 2700K
Class	III
CRI	≥90
Beam angle	36°
Cut out	ø76mm

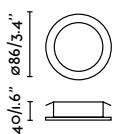

*Drivers info on page 614

560

Nais

IP23 no incl.

110V Check p. 30



- 02121001 Structure White
 Diffuser Transparent
- 02121002 Structure Black
 Diffuser Transparent

Material	Structure Aluminium + Steel
	Diffuser PMMA
Power	7W
Lumen Output	534lm
Light Source	COB LED 2700K
Class	III
CRI	≥90
Beam angle	36°
Cut out	ø60mm

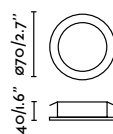

*Drivers info on page 614



Flic Orientable

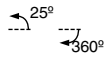

110V Check p. 30



- 44108 Structure White
- 44109 Structure Black

Material	Structure Aluminium
Light Source	1 GU10 LED MR11 max. 3W
Bulb incl.	No
Recom. Bulb	17537
Class	II
Cut out	50mm

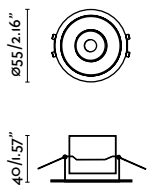

Flic Orientable Trimless

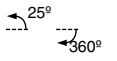

110V Check p. 30



- 44110 Structure White
- 44111 Structure Black

Material	Structure Aluminium
Light Source	1 GU10 LED MR11 max. 3W
Bulb incl.	No
Recom. Bulb	17537
Class	II
Cut out	60mm

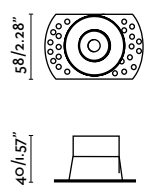

Flic Orientable Trimless 2L

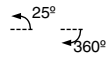

110V Check p. 30



- 44112 Structure White
- 44113 Structure Black

Material	Structure Aluminium
Light Source	1 GU10 LED MR11 max. 3W
Bulb incl.	No
Recom. Bulb	17537
Class	II
Cut out	100x52mm

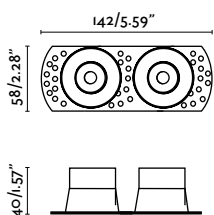

Flic Orientable Trimless 3L

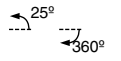

110V Check p. 30



- 44114 Structure White
- 44115 Structure Black

Material	Structure Aluminium
Light Source	1 GU10 LED MR11 max. 3W
Bulb incl.	No
Recom. Bulb	17537
Class	II
Cut out	158x52mm

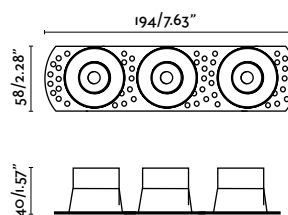

Flac

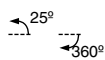

110V Check p. 30



NEW

44100 ● Structure White

44101 ● Structure Black

Material	Structure Aluminium
Light Source	1 GU10 LED MR11 max. 3W
Bulb incl.	No
Recom. Bulb	17537
Class	II
Cut out	60mm

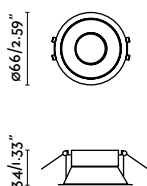

Flac IP65

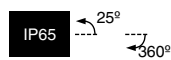

110V Check p. 30



NEW

44102 ● Structure White
● Diffuser Transparent

44103 ● Structure Black
● Diffuser Transparent

Material	Structure Aluminium
	Diffuser Glass
Light Source	1 GU10 LED MR11 max. 3W
Bulb incl.	No
Recom. Bulb	17537
Class	II
Cut out	60mm

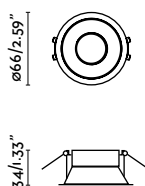

Flac Trimless

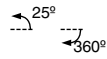

110V Check p. 30



- 44104 Structure White
- 44105 Structure Black

Material	Structure Aluminium
Light Source	1 GU10 LED MR11 max. 3W
Bulb incl.	No
Recom. Bulb	17537
Class	II
Cut out	50mm

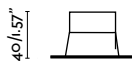
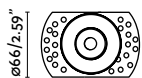

Flac Trimless IP44

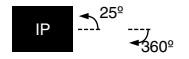

110V Check p. 30



- 44106 Structure White
 - 44107 Structure Black
- Diffuser Transparent

Material	Structure Aluminium
	Diffuser Glass
Light Source	1 GU10 LED MR11 max. 3W
Bulb incl.	No
Recom. Bulb	17537
Class	II
Cut out	50mm

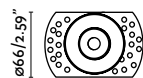

Fresh IP44

IP44

110V Check p. 30



- 02200501 **Structure** Matt White
 Diffuser Transparent

- 02200502 **Structure** Matt Black
 Diffuser Transparent

- 02200503 **Structure** Matt Gold
 Diffuser Transparent

Material	Structure Aluminium
	Diffuser Glass
Light Source	1 GU10 LED max. 8W
Bulb incl.	No
Recom. Bulb	17316
Class	II
Cut out	ø83mm

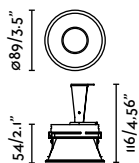

566

Fresh

110V Check p. 30



- 02100501 **Structure** Matt White

- 02100502 **Structure** Matt Black

- 02100503 **Structure** Matt Gold

Material	Structure Aluminium
Light Source	1 GU10 LED max. 8W
Bulb incl.	No
Recom. Bulb	17316
Class	II
Cut out	ø83mm

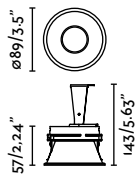

indoor

Recessed



Fresh Trimless

110V Check p. 30



- 02100701 Structure Matt White
- 02100702 Structure Matt Black

Material	Structure Aluminium
Light Source	1 GU10 LED max. 8W
Bulb incl.	No
Recom. Bulb	17316
Class	II
Cut out	ø90mm

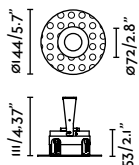

Fresh E27 Trimless

110V Check p. 30



- 02300101 Structure White

Material	Structure Aluminium
Light Source	1 E27 LED G95 max. 8W
Bulb incl.	No
Recom. Bulb	17465
Class	I
Cut out	ø74mm

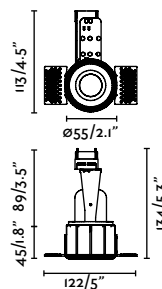



Fresh Wall Washer

110V Check p. 30



- 02100601 Structure Matt White
- 02100602 Structure Matt Black
- 02100603 Structure Matt Gold

Material	Structure Aluminium
Light Source	1 GU10 LED max. 8W
Bulb incl.	No
Recom. Bulb	17316
Class	II
Cut out	ø83mm

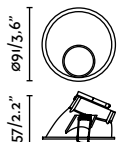

Fresh IP65

IP65

110V Check p. 30



- 02101401 Structure Matt White
- Diffuser Transparent
- 02101402 Structure Matt Black
- Diffuser Transparent

Material	Structure Aluminium
	Diffuser Glass
Light Source	1 GU10 LED max. 8W
Bulb incl.	No
Recom. Bulb	17316
Class	I
Cut out	ø83mm

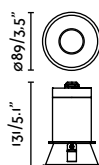

Fresh IP65 Trimlees

IP65

110V Check p. 30



- 02400102 Structure Matt Black
- Diffuser Transparent
- 02400101N Structure Matt White
- Diffuser Transparent

Material	Structure Aluminium
	Diffuser Glass
Light Source	1 GU10 LED max. 8W
Bulb incl.	No
Recom. Bulb	17316
Class	I
Cut out	Black finish ø100mm
	White finish ø90mm

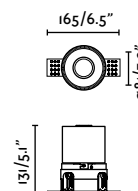

indoor

Recessed



Hyde R Orientable



110V Check p. 30



- 40118 Structure Matt White
- 40119 Structure Matt Black

Material	Structure Steel
Light Source	1 GU10 LED max. 8W
Bulb incl.	No
Recom. Bulb	17316
Class	II
Recom. Socket	GU10 BULB SOCKET for recesseds
Cut out	ø83mm

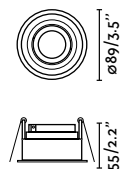

Hyde R

IP44

110V Check p. 30



- 40114 Structure Matt White
- 40115 Structure Matt Black

Material	Structure Steel
Light Source	1 GU10 LED max. 8W
Bulb incl.	No
Recom. Bulb	17316
Class	II
Recom. Socket	GU10 BULB SOCKET for recesseds
Cut out	ø83mm

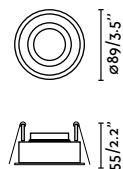

Hyde R Orientable Trimless



110V Check p. 30



- 40110 Structure Matt White
- 40111 Structure Matt Black

Material	Structure Steel
Light Source	1 GU10 LED max. 8W
Bulb incl.	No
Recom. Bulb	17316
Class	II
Recom. Socket	GU10 BULB SOCKET for recesseds
Cut out	ø104mm

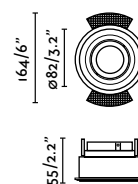

indoor

Recessed

Hyde SQ Orientable

60°

110V Check p. 30



- 40120 Structure Matt White
- 40121 Structure Matt Black

Material	Structure Steel
Light Source	1 GU10 LED max. 8W
Bulb incl.	No
Recom. Bulb	17316
Class	II
Recom.Socket	GU10 BULB SOCKET for recesseds
Cut out	83x83mm

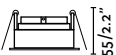

Hyde SQ

IP44

110V Check p. 30



- 40116 Structure Matt White
- 40117 Structure Matt Black

Material	Structure Steel
Light Source	1 GU10 LED max. 8W
Bulb incl.	No
Recom. Bulb	17316
Class	II
Recom.Socket	GU10 BULB SOCKET for recesseds
Cut out	83x83mm



Hyde SQ Orientable Trimless

60°

110V Check p. 30



- 40112 Structure Matt White
- 40113 Structure Matt Black

Material	Structure Steel
Light Source	1 GU10 LED max. 8W
Bulb incl.	No
Recom. Bulb	17316
Class	II
Recom.Socket	GU10 BULB SOCKET for recesseds
Cut out	102x93mm

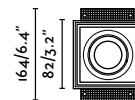

Hyde SQ Orientable 2L

60°

110V Check p. 30



- 40126 Structure Matt White
- 40127 Structure Matt Black

Material	Structure Steel
Light Source	2 GU10 LED max. 8W
Bulb incl.	No
Recom. Bulb	17316
Class	II
Recom.Socket	GU10 BULB SOCKET for recesseds
Cut out	83x165mm

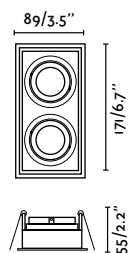

Hyde SQ 2L

IP44

110V Check p. 30



- 40124 Structure Matt White
- 40125 Structure Matt Black

Material	Structure Steel
Light Source	2 GU10 LED max. 8W
Bulb incl.	No
Recom. Bulb	17316
Class	II
Recom.Socket	GU10 BULB SOCKET for recesseds
Cut out	83x165mm

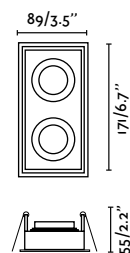

Hyde SQ Orientable Trimless 2L

60°

110V Check p. 30



- 40122 Structure Matt White
- 40123 Structure Matt Black

Material	Structure Steel
Light Source	2 GU10 LED max. 8W
Bulb incl.	No
Recom. Bulb	17316
Class	II
Recom.Socket	GU10 BULB SOCKET for recesseds
Cut out	182x93mm

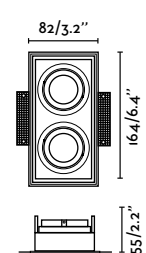

Radon R



Radon SQ



Radon RCT



110V Check p. 30



- 43398 Structure Matt White
- 43408 Structure Matt Black

110V Check p. 30

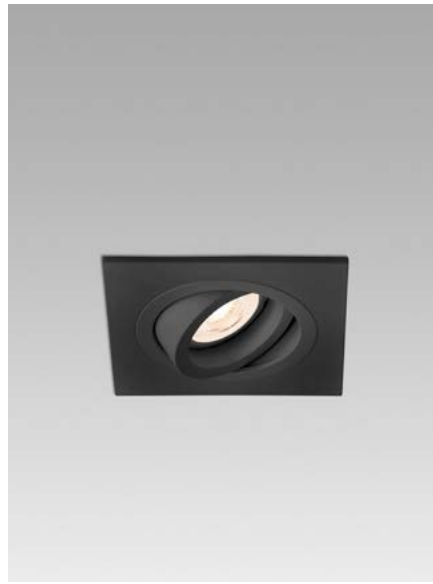

- 43396 Structure Matt White
- 43406 Structure Matt Black

110V Check p. 30



- 43397 Structure Matt White
- 43407 Structure Matt Black

Material	Structure Aluminium
Light Source	1 GU10 LED max. 8W
Bulb incl.	No
Recom. Bulb	17316
Class	II
Cut out	ø80mm

Material	Structure Aluminium
Light Source	1 GU10 LED max. 8W
Bulb incl.	No
Recom. Bulb	17316
Class	II
Cut out	ø80mm

Material	Structure Aluminium
Light Source	2 GU10 LED max. 8W
Bulb incl.	No
Recom. Bulb	17316
Class	II
Cut out	80x170mm

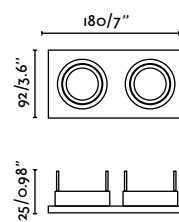
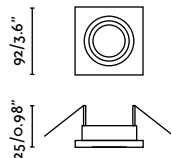
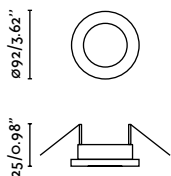



Argon R



110V Check p. 30



- 43401 Structure Matt White
- 43411 Structure Matt Black

Material	Structure Aluminium
Light Source	1 GU10 LED max. 8W
Bulb incl.	No
Recom. Bulb	17316
Class	II
Cut out	ø100mm

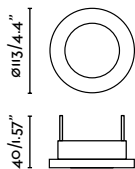

Argon SQ



110V Check p. 30



- 43402 Structure Matt White
- 43412 Structure Matt Black

Material	Structure Aluminium
Light Source	1 GU10 LED max. 8W
Bulb incl.	No
Recom. Bulb	17316
Class	II
Cut out	100x100mm

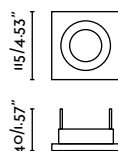

Argon RCT



110V Check p. 30



- 43403 Structure Matt White
- 43413 Structure Matt Black

Material	Structure Aluminium
Light Source	2 GU10 LED max. 8W
Bulb incl.	No
Recom. Bulb	17316
Class	II
Cut out	220x102mm

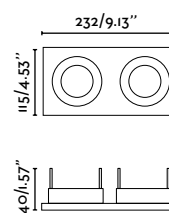



Neon SQ

110V Check p. 30



- 43400 Structure Matt White
- 43410 Structure Matt Black

Material	Structure Aluminium
Light Source	1 GU10 LED max. 8W
Bulb incl.	No
Recom. Bulb	17316
Class	II
Cut out	70x70mm

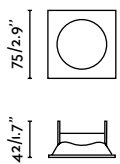

Neon R

110V Check p. 30



- 43399 Structure Matt White
- 43409 Structure Matt Black

Material	Structure Aluminium
Light Source	1 GU10 LED max. 8W
Bulb incl.	No
Recom. Bulb	17316
Class	II
Cut out	ø65mm

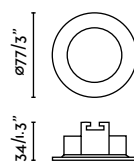

indoor

Recessed



Wet

IP44

110V Check p. 30



02100801

- Structure Matt White
- Diffuser Transparent

Material	Structure Steel
	Diffuser Glass
Light Source	1 GU10 LED max. 8W
Bulb incl.	No
Recom. Bulb	17316
Class	II
Cut out	ø65mm

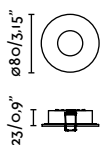

Moist

IP44

110V Check p. 30



02100901

- Structure Matt White
- Diffuser Transparent

Material	Structure Steel
	Diffuser Glass
Light Source	1 GU10 LED max. 8W
Bulb incl.	No
Recom. Bulb	17316
Class	II
Cut out	78x78mm

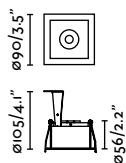

indoor

Recessed



Niva Pinhole

110V Check p. 30



43425 ● Structure White

43426 ● Structure Black

Material	Structure Aluminium
Light Source	1 GU10 LED max. 10W
Bulb incl.	No
Recom. Bulb	17316
Class	II
Cut out	85mm

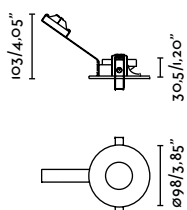

Niva Pinhole Directional

30°

110V Check p. 30



43427 ● Structure White

43428 ● Structure Black

Material	Structure Aluminium
Light Source	1 GU10 LED max. 10W
Bulb incl.	No
Recom. Bulb	17316
Class	II
Cut out	85mm

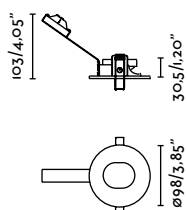

indoor

Recessed



Niva Pinhole IP65

IP65



- 43429 Structure White
- Diffuser Transparent

- 43430 Structure Black
- Diffuser Transparent

Material	Structure Aluminium
	Diffuser Glass
Light Source	1 GU10 LED max. 10W
Bulb incl.	No
Recom. Bulb	17316
Class	II
Cut out	85mm

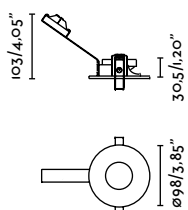

Niva Pinhole Directional IP65

IP65



- 43431 Structure White
- Diffuser Transparent

- 43432 Structure Black
- Diffuser Transparent

Material	Structure Aluminium
	Diffuser Glass
Light Source	1 GU10 LED max. 10W
Bulb incl.	No
Recom. Bulb	17316
Class	II
Cut out	85mm

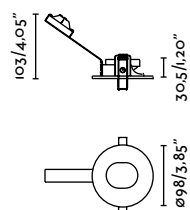

indoor

Recessed



Gas R

110V Check p. 30



- 43404 ● Structure Matt White
43405 ● Structure Matt Black

Material	Structure Aluminium
Light Source	1 GU10 LED max. 8W
Bulb incl.	No
Recom. Bulb	17316
Class	II
Cut out	ø76mm

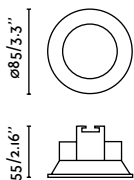

Gas RCT

110V Check p. 30



- 43420 ● Structure Matt White
43421 ● Structure Matt Black

Material	Structure Aluminium
Light Source	2 GU10 LED max. 8W
Bulb incl.	No
Recom. Bulb	17316
Class	II
Cut out	168x78mm

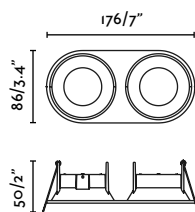

no incl.

Neu

60°

110V Check p. 30



- 63286 ● Structure Matt White

Material	Structure Plaster
Light Source	1 GU5.3 LED MR16 max. 8W
Bulb incl.	No
Recom. Bulb	97686327
Class	III
Cut out	ø160mm

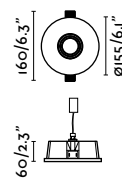



Dop 83

IP54  incl.



44003 ● Structure White
2700K 676lm ● Diffuser Opal

44004 ● Structure White
3000K 712lm ● Diffuser Opal

Material	Structure Aluminium
	Diffuser PC
Power	8W
Light Source	SMD LED
Class	II
CRI	≥90
Voltage	220V-240V/50/60Hz
Beam angle	85°
Cut out	ø75mm



Dop 105

IP54  incl.



44005 ● Structure White
2700K 1268lm ● Diffuser Opal

44006 ● Structure White
3000K 1335lm ● Diffuser Opal

Material	Structure Aluminium
	Diffuser PC
Power	15W
Light Source	SMD LED
Class	II
CRI	≥90
Voltage	220V-240V/50/60Hz
Beam angle	85°
Cut out	ø95mm



Dop 158

IP54  incl.



44007 ● Structure White
2700K 2565lm ● Diffuser Opal

44008 ● Structure White
3000K 2700lm ● Diffuser Opal

Material	Structure Aluminium
	Diffuser PC
Power	33W
Light Source	SMD LED
Class	II
CRI	≥90
Voltage	220V-240V/50/60Hz
Beam angle	85°
Cut out	ø145mm

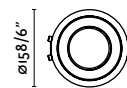

indoor

Recessed



Luan

IP44  incl.



42931 ● Structure Matt White
● Diffuser Opal

Material	Structure Aluminium
	Diffuser PMMA
Power	40W
Lumen Output	3011lm
Light Source	SMD LED 3000K
Class	II
CRI	>80
Voltage	100V-240V/50/60Hz
Cut out	ø375mm

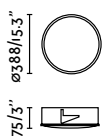

Ebba

IP44  incl.



42919 ● Structure Satin Nickel
● Diffuser Opal

Material	Structure Aluminium
	Diffuser PMMA
Power	4W
Lumen Output	458lm
Light Source	SMD LED 3000K
Class	II
CRI	>80
Voltage	220V-240V/50/60Hz
Cut out	ø63mm

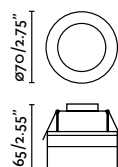



Navi



Tuk



Plas RCT



110V Check p. 30



63481 ● Structure White

Material	Structure Plaster
Power	10W
Lumen Output	500lm
Light Source	SMD LED 2700K
Class	II
CRI	>80
Voltage	100V-240V/50/60Hz
Cut out	273x273mm

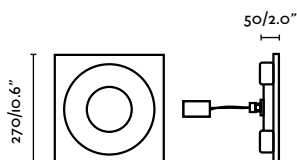

63425 ● Structure White

Material	Structure Plaster + Aluminium
Power	2W
Lumen Output	97lm
Light Source	SMD LED 2700K
Class	II
CRI	90
Voltage	220V-240V
Beam angle	35°
Cut out	103x103mm

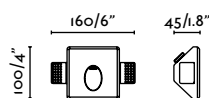

110V Check p. 30



63490 ● Structure White
3000K 153lm
63491 ● Structure White
2700K 150lm

Material	Structure Plaster
Power	3W
Light Source	HIGH POWER LED
Class	II
CRI	>80
Voltage	100V-240V/50/60Hz
Cut out	248x113mm

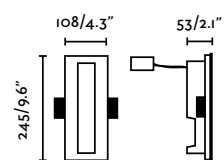

indoor

Recessed



Plas Oval

no incl. DIM

110V Check p. 30



63281 ● Structure Matt White

Material	Structure Plaster
Power	1W
Lumen Output	63lm
Light Source	HIGH POWER LED 3000K
Class	III
CRI	>80
Cut out	175x110mm

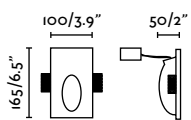

*Drivers info on page 614

Plas Linear

no incl. DIM

110V Check p. 30

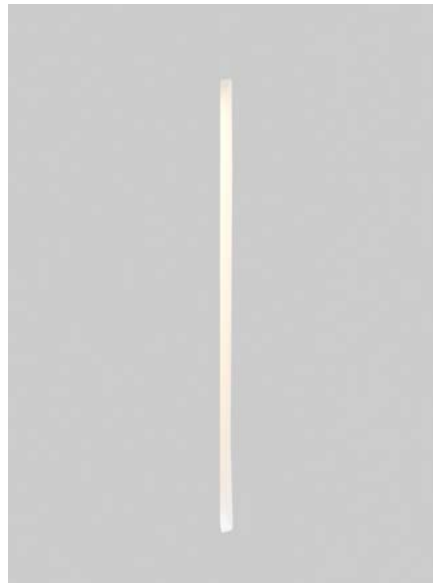

63282 ● Structure Matt White

Material	Structure Plaster
Power	1W
Lumen Output	22lm
Light Source	HIGH POWER LED 3000K
Class	III
CRI	>80
Cut out	231x85mm

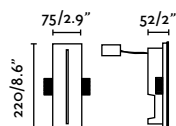

Plas SQ

no incl. DIM

110V Check p. 30



63283 ● Structure Matt White

Material	Structure Plaster
Power	1W
Lumen Output	65lm
Light Source	HIGH POWER LED 3000K
Class	III
CRI	>80
Cut out	155x110mm

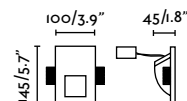

indoor

Recessed





INDOOR

LIGHTING

TRACK

Stan Slim

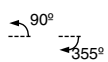

110V Check p. 30



43806  Structure White + Matt Black

43807  Structure Black + Matt Black

Material	Structure Aluminium + ABS
Light Source	1 GU10 LED MR11 max. 3W
Bulb incl.	No
Recom. Bulb	17537
Class	I

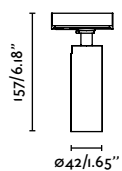

*Stan Slim accessories page 290

indoor

Track



Stan LED

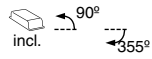

- 43724** 2700K 1016lm Structure Matt White + Matt Black Diffuser Transparent
- 43725** 2700K 1016lm Structure Matt Black + Matt Black Diffuser Transparent
- 43770** 3000K 942lm Structure Matt Black + Matt Black Diffuser Transparent
- 43771** 3000K 942lm Structure Matt White + Matt Black Diffuser Transparent

Material	Structure Aluminium + ABS
	Diffuser PC
Power	12W
Light Source	COB LED
Class	I
CRI	>80
Voltage	220V-240V/50/60Hz

Stan GU10

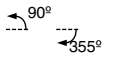

110V Check p. 30



- 43720** Structure Matt White + Matt Black Structure Matt Black + Matt Black
- 43721** Structure Matt Black + Matt Black
- 43757** Structure Satin Gold + Matt Black

Material	Structure Aluminium + ABS
Light Source	1 GU10 LED max. 5W
Bulb incl.	No
Recom. Bulb	17334
Class	I

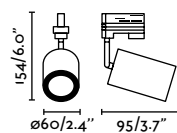
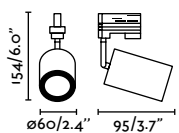
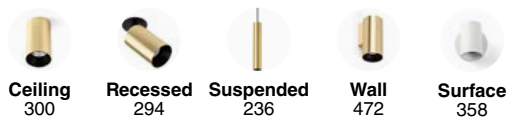

*Accessories page 294



Leo
Estudi Ribaudí

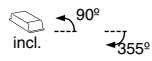

- 43794 **Structure** Matt White
- 43795 **Structure** Matt Black

Material	Structure Aluminium
Power	7W
Lumen Output	590lm
Light Source	COB LED 2700K
Class	II
CRI	≥90
Voltage	220V-240V/50/60Hz



Surface track 1mts

- 64210A White
- 64212A Black
- 64214A Grey

Material	Structure Aluminium
-----------------	----------------------------

Surface track 2mts

- 64211A White
- 64213A Black
- 64215A Grey

Material	Structure Aluminium
-----------------	----------------------------

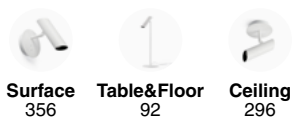
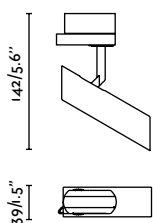

indoor

Track



INDOOR

LIGHTING

BULBS

LED Module



Ref.	Power (W)	Flux (Lm)	Color T° (K)	CRI	Beam Angle (°)	Useful life (H)	Diffuser	Width (mm/in)	Height (mm/in)	IEE
18036	7/10W	564 lm 864 lm	2700K	90	36°	50.000h L70 B10	Transparent PMMA	ø50/2"	56/2.2"	F
18037	7/10W	586 lm 898 lm	3000K	90	36°	50.000h L70 B10	Transparent PMMA	ø50/2"	56/2.2"	F
18038	7/10W	610 lm 934 lm	4000K	90	36°	50.000h L70 B10	Transparent PMMA	ø50/2"	56/2.2"	F
18039	15W	1040lm	2700K	90	36°	50.000h L70 B10	Transparent PMMA	ø50/2"	56/2.2"	G
18040	15W	1072lm	3000K	90	36°	50.000h L70 B10	Transparent PMMA	ø50/2"	56/2.2"	G
18041	15W	1104lm	4000K	90	36°	50.000h L70 B10	Transparent PMMA	ø50/2"	56/2.2"	G























*Drivers info on page 620

G9 LED

Ref.	Power (W)	Flux (Lm)	Color T° (K)	CRI	Beam Angle	Dimm	Useful life (H)	Diffuser	Width (mm/in)	Height (mm/in)	IEE
17443	3,5W	350lm	2700K	≥80	360°		15.000h	Transparent Glass	ø16/0.6"	50/2"	F
17468	3,5W	350lm	2700K	≥80	360°		15.000h	Transparent Glass	ø16/0.6"	50/2"	F
17444	3,5W	350lm	4000K	≥80	360°		15.000h	Transparent Glass	ø16/0.6"	50/2"	F
17495	4W	470lm	3000K	≥80	360°		15.000h	Transparent Glass	ø14/0.6"	65/2.6"	E
17466	4,5W	450lm	2700K	≥80	360°		15.000h	Transparent Glass	ø16/0.6"	60/2.4"	F





GU10 LED











Ref.		Power	Flux	Color T°	CRI	Beam Angle	Dimm	Useful life	Width	Height	IEE
		(W)	(Lm)	(K)				(H)	(mm/in)	(mm/in)	
17330		7W	500lm	3000K	≥80	38°		15.000h	ø50/2"	55/2.2"	E
17333		5W	440lm	2700K	≥80	60°		15.000h	ø50/2"	50/2"	F
17309		7W	545lm	3000K	≥90	40°		25.000h	ø50/2"	54/2.1"	G
17320		7,5W	604lm	2700K	≥80	60°		25.000h	ø50/2"	54/2.1"	G
17318		8W	563lm	2700K	≥80	38°		25.000h	ø50/2"	54/2.1"	G
17316		7W	632lm	2700K	≥80	38°		25.000h	ø50/2"	54/2.1"	F
17319		8W	560lm	4000K	≥80	38°		25.000h	ø50/2"	54/2.1"	G
17321		8W	662lm	4000K	≥80	60°		25.000h	ø50/2"	54/2.1"	F
17335 NEW		5W	450lm	2700K	≥90	38°		15.000h	ø50/2"	50/2"	E
17334		5W	440lm	2700K	≥80	60°		15.000h	ø50/2"	50/2"	F
17337 NEW		5W	450lm	3000K	≥90	38°		15.000h	ø50/2"	50/2"	E
17336 NEW		5W	450lm	3000K	≥90	60°		15.000h	ø50/2"	54/2.1"	E
17331		8W	560lm	2700K	≥80	60°		25.000h	ø50/2"	54/2.1"	G
17324		8W	629lm	2700K	≥80	60°		25.000h	ø50/2"	54/2.1"	F
17332		8,7W	671lm	4000K	≥80	60°		25.000h	ø50/2"	54/2.1"	G
17325		7W	610lm	4000K	≥80	25°		25.000h	ø50/2"	54/2.1"	F
17328		7W	560lm	2700K	≥80	120°		15.000h	ø50/2"	55/2.2"	F
17329		7W	560lm	4000K	≥80	120°		15.000h	ø50/2"	55/2.2"	F



MR11 GU10























Ref.		Power	Flux	Color T°	CRI	Beam Angle	Dimm	Useful life	Width	Height	IEE
17537 NEW		MR11	3W	220lm	2700K	≥80	38°	15.000h	ø35/1.4"	47/1.9"	F
17538 NEW		MR11	3W	230lm	3000K	≥80	38°	15.000h	ø35/1.4"	74/2.9"	F

E14

Ref.		Power	Flux	Color T°	CRI	Beam Angle	Dimm	Useful life	Diffuser	Width	Height	IEE
17427		C35	2W	160lm	2200K	≥80	360°	15.000h	Transparent Glass	ø36/1.4"	100/3.9"	G
17533		C35	4W	300lm	2200K	>90	360°	15.000h	Opal Glass	ø35/1.4"	100/3.9"	G
17460		C35	4W	400lm	2700K	≥80	360°	15.000h	Opal Glass	ø35/1.4"	100/3.9"	F
17534		C35	4W	400lm	3000K	≥90	360°	15.000h	Opal Glass	ø35/1.4"	100/3.9"	F
17413		G45	2W	160lm	2200K	≥80	360°	15.000h	Amber Glass	ø45/1.8"	78/3.1"	G
17526		G45	4W	300lm	2200K	≥90	360°	15.000h	Opal Glass	ø45/1.8"	78/3.1"	G
17461		G45	4W	390lm	2700K	≥80	360°	15.000h	Opal Glass	ø45/1.8"	78/3.1"	F
17527		G45	4W	400lm	3000K	≥90	360°	15.000h	Opal Glass	ø45/1.8"	78/3.1"	F
17519		G45	4,5W	400lm	2700K	≥80	360°	 15.000h	Opal Glass	ø45/1.8"	78/3.1"	F
17446		T26	1W	120lm	2700K	≥80	360°	15.000h	Transparent Glass	ø25/1"	58/2.3"	E



























E27 LED

Ref.		Power	Flux	Color T°	CRI	Beam Angle	Dimm	Useful life	Diffuser	Width	Height	IEE
		(W)	(Lm)	(K)				(H)		(mm/in)	(mm/in)	
17420		A60	4W	470lm	2700K	≥80	360°	15.000h	Transparent Glass	ø60/2.4"	102/4"	E
17498		A60	7W	806lm	2700K	≥80	360°	 25.000h	Transparent Glass	ø60/2.4"	102/4"	F
17528		A60	8W	650lm	2200K	≥90	360°	15.000h	Opal Glass	ø60/2.4"	102/4"	G
17463		A60	8W	800lm	2700K	≥90	360°	15.000h	Opal Glass	ø60/2.4"	102/4"	F
17485		A60	8W	850lm	2700K	≥80	360°	 15.000h	Opal Glass	ø60/2.4"	102/4"	F
17529		A60	8W	810lm	3000K	≥90	360°	15.000h	Opal Glass	ø60/2.4"	102/4"	F
17530		A60	8W	820lm	4000K	≥90	360°	15.000h	Opal Glass	ø60/2.4"	102/4"	F
17067		A60	9W	850lm	2700K	≥80	270°	 15.000h	Opal PC	ø60/2.4"	120/4.7"	F
17070		A60	9W	820lm	2700K	≥80	270°	15.000h	Opal PC	ø60/2.4"	110/4.3"	F
17074		A60	9W	820lm	4000K	≥80	270°	15.000h	Opal PC	ø60/2.4"	110/4.3"	F
17426		A60	4W	400lm	2200K	≥80	360°	15.000h	Amber Glass	ø56/2.2"	102/4"	F
17432		A60	5W	440lm	2200K	≥80	360°	 15.000h	Amber Glass	ø60/2.4"	102/4"	F
17496		A60	4W	450lm	2700K	≥80	360°	15.000h	Gloss Gold Glass	ø60/2.4"	102/4"	E
17071		A60	4W	400lm	2700K	≥80	360°	 15.000h	Matt Black Glass	ø60/2.4"	102/4"	F
17073		A60	4W	400lm	2700K	≥80	360°	 15.000h	Mirror Glass	ø60/2.4"	102/4"	F
17417		G45	2W	220lm	2700K	≥80	360°	15.000h	Transparent Glass	ø45/1.8"	75/3"	E
17524		G45	4W	300lm	2200K	≥90	360°	15.000h	Opal Glass	ø45/1.8"	75/3"	G
17541 NEW		G45	4W	280lm	2200K	≥90	360°	 15.000h	Opal Glass	ø45/1.8"	75/3"	G

















E27 LED





Ref.		Power	Flux	Color T°	CRI	Beam Angle	Dimm	Useful life	Diffuser	Width	Height	IEE
17462		G45	4W	400lm	2700K	≥80	360°	15.000h	Opal Glass	ø45/1.8"	75/3"	F
17525		G45	4W	400lm	3000K	≥90	360°	15.000h	Opal Glass	ø45/1.8"	75/3"	F
17518		G45	4,5W	400lm	2700K	≥80	360° 	15.000h	Opal Glass	ø45/1.8"	75/3"	F
17414		G45	2W	160lm	2200K	≥80	360°	15.000h	Amber Glass	ø45/1.8"	75/3"	G
17493		G45	4W	300lm	2200K	≥80	360° 	15.000h	Amber Glass	ø45/1.8"	75/3"	G
17415		G95	4W	470lm	2700K	≥80	360°	15.000h	Transparent Glass	ø95/3.7"	125/4.9"	E
17531		G95	8W	650lm	2200K	≥90	360°	15.000h	Opal Glass	ø95/3.7"	141/5.6"	G
17464		G95	8W	800lm	2700K	≥80	360°	15.000h	Opal Glass	ø95/3.7"	141/5.6"	F
17482		G95	8W	900lm	2700K	≥80	360° 	25.000h	Opal Glass	ø95/3.7"	130/5.1"	F
17532		G95	8W	810lm	3000K	≥90	360°	15.000h	Opal Glass	ø95/3.7"	141/5.6"	F
17542 NEW		G95	12W	1200lm	2200K	≥90	360° 	15.000h	White Glass	ø95/3.7"	125/4.9"	F
17543 NEW		G95	12W	1500lm	2700K	≥90	360° 	15.000h	White Glass	ø95/3.7"	141/5.6"	E
17429		G95	4W	400lm	2200K	≥80	360°	15.000h	Amber Glass	ø95/3.7"	125/4.9"	F
17072		G95	4W	400lm	2700K	≥80	360° 	15.000h	Matt Black Glass	ø95/3.7"	125/4.9"	F
17271		G95	4W	450lm	2700K	≥80	360°	15.000h	Mirror Glass	ø95/3.7"	125/4.9"	E
17478		G120	18W	1850lm	2700K	≥80	270°	15.000h	Opal Glass	ø120/4.7"	158/6.2"	F
17479		G120	18W	1600lm	2700K	≥80	215° 	25.000h	Opal Glass	ø120/4.7"	158/6.2"	F
17423		G125	4W	470lm	2700K	≥80	360°	15.000h	Transparent Glass	ø125/4.9"	175/6.9"	E





E27 LED

Ref.		Power	Flux	Color T°	CRI	Beam Angle	Dimm	Useful life	Diffuser	Width	Height	IEE
17425		G125	4W	400lm	2200K	≥80	360°	15.000h	Amber Glass	ø125/4.9"	175/6.9"	F
17434		G125	5W	440lm	2200K	≥80	360°	 15.000h	Amber Glass	ø125/4.9"	175/6.9"	F
17422		ST64	4W	470lm	2700K	≥80	360°	15.000h	Transparent Glass	ø64/2.5"	146/5.7"	E
17428		ST64	4W	400lm	2200K	≥80	360°	15.000h	Amber Glass	ø64/2.5"	146/5.7"	F
17433		ST64	5W	440lm	2200K	≥80	360°	 15.000h	Amber Glass	ø64/2.5"	146/5.7"	F
17424		ST64	5W	612lm	2700K	≥90	360°	15.000h	Amber Glass	ø64/2.5"	146/5.7"	E
17409		SP64	5W	380lm	2000K	≥80	360°	 15.000h	Amber Glass	ø64/2.5"	146/5.7"	G
17400		PAR38	10W	850lm	4000K	≥80	60°	30.000h	Opal Glass	ø120/4.7"	134/5.3"	F
17398		PAR38	11W	1052lm	3000K	≥80	23°	25.000h	Transparent Glass	ø120/4.7"	134/5.3"	F
17477		R80	12W	1050lm	2700K	≥80	120°	15.000h	Opal PC	ø80/3.1"	110/4.3"	E
17437		T45	5W	550lm	3000K	≥80	360°	15.000h	Opal Glass	ø45/1.8"	112/4.4"	E

E27 LED SPECIALS





Ref.		Power	Flux	Color T°	CRI	Beam Angle	Dimm	Useful life	Diffuser	Width	Height	IEE
17445		T30	6W	550lm	2200K	≥80	360°	15.000h	Amber Glass	ø28/1.1"	300/11.8"	F
17447		A160	5W	280lm	2000K	≥80	360°	 25.000h	Amber Glass	ø160/6.3"	300/11.8"	G
17449		BT180	8W	400lm	2000K	≥80	360°	 25.000h	Amber Glass	ø160/6.3"	390/15.4"	G

G4



Ref.		Power	Flux	Color T°	CRI	Beam Angle	Dimm	Useful life	Diffuser	Width	Height	IEE
17487			1,5W	155lm	3000K	≥80	360°	15.000h	Transparent Glass	ø11/0.4"	41/1.6"	F
17494			1,5W	90lm	3000K	≥80	360°	25.000h	Transparent Glass	ø11/0.4"	33/1.3"	G



R7s LED

Ref.		Power (W)	Flux (Lm)	Color T° (K)	CRI	Beam Angle	Dimm	Useful life (H)	Diffuser	Width (mm/in)	Height (mm/in)	IEE
17499		4W	500lm	2700K	≥80	360°		15.000h	Transparent Glass	ø45/1.8"	45/1.8"	F
17503		4W	500lm	4000K	≥80	360°		15.000h	Transparent Glass	ø16/0.6"	78/3.1"	E
17488		5,5W	550lm	2700K	≥80	360°		15.000h	Transparent PC	ø23/0.9"	23/0.9"	F
17497		8W	850lm	2700K	≥80	360°		15.000h	Transparent Glass	ø16/0.6"	16/0.6"	F
17502		8W	850lm	4000K	≥80	360°		15.000h	Transparent Glass	ø16/0.6"	16/0.6"	F

LINESTRA

Ref.		Power (W)	Flux (Lm)	Color T° (K)	CRI	Beam Angle	Dimm	Useful life (H)	Diffuser	Width (mm/in)	Height (mm/in)	IEE
17535		L300	5W	430lm	2700K	≥80	270°	15.000h	Opal Glass	ø29/1.1"	29/1.1"	F
17536		L500	7W	608lm	2700K	≥80	270°	15.000h	Opal Glass	ø29/1.1"	29/1.1"	F

GX53

Ref.		Power (W)	Flux (Lm)	Color T° (K)	CRI	Beam Angle	Dimm	Useful life (H)	Diffuser	Width (mm/in)	Height (mm/in)	IEE
17340		6W	540lm	3000K	>80	120°		25.000h	Opal PC	ø30/1.2"	76/3"	F

*Items with special discount conditions

LED Bulb GU5.3

PARATHOM MR16

	Socket	Power	CRI	Useful life	DIM	Beam	Flux	Color T°	
	GU5.3	97692327	12W	95	35.000h	✓	8°	575lm	2700K
		97692330	12W	95	35.000h	✓	8°	620lm	3000K
		97692427	12W	95	35.000h	✓	36°	575lm	2700K
		97692430	12W	95	35.000h	✓	36°	620lm	3000K
		97686230	8W	92	40.000h	✓	24°	500lm	3000K
		97686327	8W	92	40.000h	✓	36°	485lm	2700K
		97686330	8W	92	40.000h	✓	36°	500lm	3000K

LED bulb GU10 MASTER LED Spot MV

	Socket	Power	CRI	Useful life	DIM	Beam	Flux	Color T°	
	SOCKET GU10	97685327	4W	80	15.000h	✓	36°	345lm	2700K
		97685330	5W	80	25.000h	✓	36°	365lm	3000K
		97264	4W	80	15.000h	✓	60°	355lm	2700K
		97404	5W	90	15.000h	✓	60°	375lm	3000K
		97273	5W	97	40.000h	✓	36°	355lm	2700K
		97402	5,5W	97	40.000h	✓	36°	375lm	3000K

LED bulb GU10 PARATHOM GU10

	Socket	Power	CRI	Useful life	DIM	Beam	Flux	Color T°	
	SOCKET GU10	97166	6W	≥80	15.000h		36°	575lm	2700K
		97291	6W	≥80	15.000h		36°	575lm	3000K
		97292	6W	≥80	15.000h		60°	575lm	3000K
		97403	6W	≥80	15.000h		60°	575lm	2700K

QR111 PARATHOM QR111

	Socket	Power	CRI	Useful life	DIM	Beam	Flux	Color T°	
	SOCKET G53	97411	15W	97	40.000h	✓	24°	800lm	2700K
		97412	15W	97	40.000h	✓	24°	800lm	3000K
		97413	15W	97	40.000h	✓	40°	800lm	2700K
		97414	15W	97	40.000h	✓	40°	800lm	3000K

PAR30 PARATHOM PAR30

















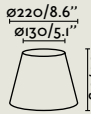

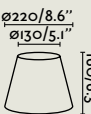

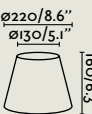

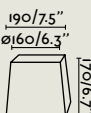

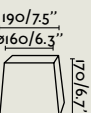

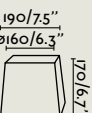



	Socket	Power	CRI	Useful life	DIM	Beam	Flux	Color T°
97687127	E27	10W	≥80	25.000h	✓	36°	633lm	2700K

DRIVERS

		mA	P	V	units		
FOX 3W	02101001 02101002	350mA	3W	220/240V	1-5 units	on/off	98310136
					2-3 units	triac	98310110LC
					1-5units	dali	98310136D
					2-5 units	casambi	98310538
FOX 5W	02101001 02101002	500mA	5W	220/240V	1-4 units	on/off	98310336
					2-4 units	triac	98310321LC
					1-4 units	dali	98310336D
					1-5 units	casambi	98310538
FOX TRIMLESS 3W	02101101 02101102	350mA	3W	220/240V	1-5 units	on/off	98310136
					2-3 units	triac	98310110LC
					1-5units	dali	98310136D
					2-5 units	casambi	98310538
FOX TRIMLESS 5W	02101101 02101102	500mA	5W	220/240V	1-4 units	on/off	98310336
					2-4 units	triac	98310321LC
					1-4 units	dali	98310336D
					1-5 units	casambi	98310538
FOX ORIENTABLE 3W	02101301 02101302	350mA	3W	220/240V	1-5 units	on/off	98310136
					2-3 units	triac	98310110LC
					1-5units	dali	98310136D
					2-5 units	casambi	98310538
FOX ORIENTABLE 5W	02101301 02101302	500mA	5W	220/240V	1-4 units	on/off	98310336
					2-4 units	triac	98310321LC
					1-4 units	dali	98310336D
					1-5 units	casambi	98310538
FOX 7W	02101501	350mA	7W	220/240V	1-2 units	on/off	98310136
					1 units	triac	98310110LC
					1-2 units	dali	98310136D
					2 units	casambi	98310538
FOX 10W	02101601	500mA	10W	220/240V	1-2 units	on/off	98310336
					2 units	triac	98310321LC
					1-2 units	dali	98310336D
					2 units	casambi	98310538
CLEAR 7W	02100301	350mA	7W	220/240V	1-2 units	on/off	98310136
					1 units	triac	98310110LC
					1-2 units	dali	98310136D
					1-2 units	casambi	98310538
PLAS 1W	63281 63283 63282	350mA	1W	220/240V	only 1 unit	on/off	98310103
					2-3 units	triac	98310110LC
					5-15 units	dali	98310136D
					5-15 units	casambi	98310538
NAIS ORIENTABLE 7W	02111001 02111002	350mA	7W	220/240V	1-2 units	on/off	98310136
					1 units	triac	98310110LC
					1-2 units	dali	98310136D
					2 units	casambi	98310538
NAIS 7W	02121001 02121002	350mA	7W	220/240V	1-2 units	on/off	98310136
					1 units	triac	98310110LC
					1-2 units	dali	98310136D
					2 units	casambi	98310538
LOX 5W	43880-43881 43882-43883 43884-43885 43886-43887	150mA	5W	220/240V	1 units	on/off	98310637
					NA	triac	NA
					1 units	dali	98310636D
					NA	casambi	NA
LOX 9W	43880-43881 43882-43883 43884-43885 43886-43887	250mA	9W	220/240V	1 units	on/off	98310512
					1 units	triac	98310510C
					1 units	dali	98310536D
					NA	casambi	NA
MODULO FARO 7-10W	18036 18037 18038	150mA	7W	220/240V	1 units	on/off	98310637
					NA	triac	NA
					1 units	dali	98310636
					NA	casambi	NA
MODULO FARO 7-10W	18036 18037 18038	250mA	10W	220/240V	1 units	on/off	98310512
					1 units	triac	98310510C
					1 units	dali	98310536D
					NA	casambi	NA
MODULO FARO 15W	18039 18040 18041	350mA	15W	220/240V	1 units	on/off	98310136
					1 units	triac	98310118LC
					1 units	dali	98310136D
					1 units	casambi	98310538

Shades

Wall lamps

	2P0111 Ø215/8.6" Ø190/7.6" 160/6.3" 		2P0112 Ø215/8.6" Ø190/7.6" 160/6.3" 		2P0113 Ø215/8.6" Ø190/7.6" 160/6.3" 
	2P0211 Ø220/8.6" Ø130/5.1" 160/6.3" 		2P0212 Ø220/8.6" Ø130/5.1" 160/6.3" 		2P0213 Ø220/8.6" Ø130/5.1" 160/6.3" 
	2P0411 190/7.5" Ø160/6.3" 170/6.7" 		2P0412 190/7.5" Ø160/6.3" 170/6.7" 		2P0413 190/7.5" Ø160/6.3" 170/6.7" 
	2P0311 Ø165/6.5" Ø130/5.1" 240/9.4" 		2P0312 Ø165/6.5" Ø130/5.1" 240/9.4" 		2P0313 Ø165/6.5" Ø130/5.1" 240/9.4" 
	2P0615 Ø215/8.6" Ø190/7.6" 160/6.3" 		2P0616 Ø215/8.6" Ø190/7.6" 160/6.3" 		2P0617 Ø215/8.6" Ø190/7.6" 160/6.3" 
	2P0710 Ø210/8.2" 160/6.3" 		2P0763 Ø210/8.3" Ø120/4.7" 160/6.3" 		

Suspended



2P0141

ø500/19.7"
ø450/17.7"
350/13.8"



2P0142

ø500/19.7"
ø450/17.7"
350/13.8"



2P0143

ø500/19.7"
ø450/17.7"
350/13.8"



2P0645

ø500/19.7"
ø450/17.7"
350/13.8"



2P0646

ø500/19.7"
ø450/17.7"
350/13.8"



2P0647

ø500/19.7"
ø450/17.7"
350/13.8"



2P0710

ø210/8.2"
160/6.3"



2P0720

ø320/12.6"
210/8.2"



2P0730

ø450/17.7"
310/12.2"



2P0765

ø250/9.8"
190/9.8"



2P0766

ø300/11.8"
230/9.1"



2P0767

ø530/20.9"
400/15.7"



2P0768

ø225/8.9"
ø125/4.9"
170/6.7"



2P0769

ø300/11.8"
ø168/6.6"
290/11.4"



2P0764

ø560/22"
ø315/12.4"
360/14.2"



Table lamps



2P0121

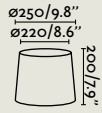

2P0122

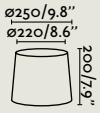

2P0123

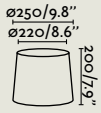

2P0221

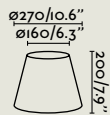

2P0222

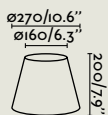

2P0223

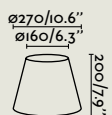

2P0421

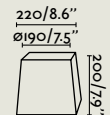

2P0422



2P0423

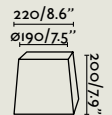

2P0311

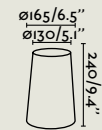

2P0312

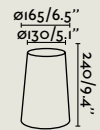

2P0313

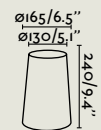

2P0625

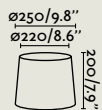

2P0626

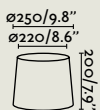

2P0627

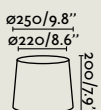

2P0720

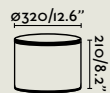

2P0763

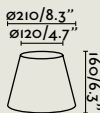

Floor lamps



2P0131

$\frac{\varnothing 400/15.7''}{\varnothing 360/14.1''}$
 $\frac{300/11.8''}{}$



2P0231

$\frac{\varnothing 400/15.7''}{\varnothing 240/9.4''}$
 $\frac{290/11.4''}{}$



2P0431

$\frac{320/12.6''}{\varnothing 270/10.6''}$
 $\frac{300/11.8''}{}$



2P0635

$\frac{\varnothing 400/15.7''}{\varnothing 360/14.1''}$
 $\frac{300/11.8''}{}$



2P0730

$\frac{\varnothing 450/17.7''}{}$
 $\frac{310/12.2''}{}$



2P0132

$\frac{\varnothing 400/15.7''}{\varnothing 360/14.1''}$
 $\frac{300/11.8''}{}$



2P0232

$\frac{\varnothing 400/15.7''}{\varnothing 240/9.4''}$
 $\frac{290/11.4''}{}$



2P0432

$\frac{320/12.6''}{\varnothing 270/10.6''}$
 $\frac{300/11.8''}{}$



2P0636

$\frac{\varnothing 400/15.7''}{\varnothing 360/14.1''}$
 $\frac{300/11.8''}{}$



2P0730

$\frac{\varnothing 450/17.7''}{}$
 $\frac{310/12.2''}{}$



2P0133

$\frac{\varnothing 400/15.7''}{\varnothing 360/14.1''}$
 $\frac{300/11.8''}{}$



2P0233

$\frac{\varnothing 400/15.7''}{\varnothing 240/9.4''}$
 $\frac{290/11.4''}{}$



2P0433

$\frac{320/12.6''}{\varnothing 270/10.6''}$
 $\frac{300/11.8''}{}$



2P0637

$\frac{\varnothing 400/15.7''}{\varnothing 360/14.1''}$
 $\frac{300/11.8''}{}$



2P0730

$\frac{\varnothing 450/17.7''}{}$
 $\frac{310/12.2''}{}$



General terms of sale

EN	ES	FR	ITA
<p>The technical information detailed in our catalogue can be modified in order to improve the features or design of our products.</p> <p>Faro Barcelona keeps the right to cancel or modify any model without prior notice and without any cause for complaints.</p> <p>The conditions, technical characteristics and prices of the products that appear in this catalogue are the effective ones in the date of impression of the catalogue except for typographical error and are subject to possible changes.</p> <p>The catalogue prices are public prices.</p> <p>RATES DO NOT INCLUDE VAT.</p> <p>Returned goods shall only be accepted, after prior notice being given to LOREFAR, on the grounds of being defective and never on the basis of broken glass or missing parts. In such cases, please contact us so that we can send you the required parts as a matter of urgency.</p> <p>Exchanges or returns of goods in good condition will not be accepted. In the event of express acceptance by LOREFAR, a 20% charge shall be incurred, on receipt and checking, for depreciation and classification of the goods.</p>	<p>La información referente a nuestros productos puede ser modificada con el fin de mejorar las características técnicas o de diseño.</p> <p>Faro Barcelona se reserva el derecho de anular o modificar cualquier modelo sin previo aviso y sin que sea motivo de reclamaciones.</p> <p>Las condiciones, características y precios de los productos que aparecen en este catálogo son los vigentes en la fecha de impresión del catálogo salvo error tipográfico y están sujetos a posibles modificaciones, la versión digital siempre prevalece.</p> <p>Los precios mostrados son precios de venta al público (PVP).</p> <p>IVA NO INCLUIDO EN TARIFA</p> <p>Previa comunicación a Lorefar sólo se aceptará la mercancía devuelta por defectuosa, nunca por cristales rotos o falta de algún componente. En estos casos rogamos se pongan en contacto con nosotros para enviarles urgentemente las piezas requeridas.</p> <p>No se admitirán cambios ni devoluciones de mercancía en buen estado. En caso de aceptación explícita por parte de Lorefar, a su recepción y comprobación se emitirá un cargo del 20% en concepto de depreciación y clasificación de la mercancía.</p>	<p>L'information qui se réfère à nos produits peut être modifiée afin d'améliorer les caractéristiques technique ou de design.</p> <p>Faro Barcelona se réserve le droit d'annuler ou de modifier n'importe quel modèle sans préavis et sans que cela soit motif de réclamations.</p> <p>Les conditions, caractéristiques et prix des produits qui apparaissent dans ce catalogue sont celles en vigueur à la date d'impression du catalogue sauf erreur typographique et sont susceptible d'être modifiées ultérieurement.</p> <p>Les prix du catalogue son les prix de vente public .</p> <p>IVA NON COMPRISE DANS LE TARIF.</p> <p>Seule sera acceptée en retour la marchandise défectueuse, et ce après communication à LOREFAR. LOREFAR n'acceptera jamais de retour pour du verre brisé ou pour l'absence d'un composant quelconque. Dans ces derniers cas, nous vous prions de vous mettre en contact avec nous afin que nous vous fassions parvenir dans les plus brefs délais les pièces nécessaires. La marchandise en bon état ne sera ni reprise ni échangée. En cas d'acceptation explicite de sa part, LOREFAR retiendra 20% au titre de la dépréciation et de la classification du produit.</p>	<p>La informazione che si riferisce ai nostri articoli può essere soggetta a modifiche con il fine di migliorare le caratteristiche, tecniche o di design, dei nostri prodotti. Faro Barcelona si riserva il diritto di annullare o modificare qualsiasi modello senza previo avviso e senza che sia motivo di reclami.</p> <p>Le condizioni, caratteristiche e prezzi dei prodotti che compaiono in questo catalogo sono quelli vigenti alla data della stampa del catalogo ad eccezione di errori tipografici e sono soggetti a possibili modificazioni.</p> <p>I prezzi indicati sono prezzi di vendita al pubblico.</p> <p>IVA NON INCLUSA IN LISTINO.</p> <p>LOREFAR accetta previa comunicazione, solo la merce restituita perché difettosa; in nessun caso accetterà la merce restituita per presenza di vetri rotti o per mancanza di qualche componente. In questi casi vi preghiamo di contattarci per potervi mandare al più presto i pezzi richiesti.</p> <p>Non si effettuano cambi né si ammettono restituzioni di merci in buono stato. In caso di accettazione esplicita da parte di LOREFAR, al momento del ricevimento e della verifica della merce si emetterà un addebito del 20% a titolo di deprezzamento e classificazione.</p>
PT	GER	NL	GRK
<p>A informação referente aos nossos produtos pode ser modificada com o fim de melhorar as características técnicas ou de desenho.</p> <p>A Faro Barcelona reserva-se o direito de anular ou modificar qualquer modelo sem aviso prévio e sem que seja motivo de reclamações.</p> <p>As condições, características e preços dos produtos que aparecem neste catálogo são os vigentes na data de impressão do catálogo salvo erro tipográfico e estão sujeitos a possíveis modificações. Os preços mostrados são preços de venda ao público (PVP).</p> <p>IVA NÃO INCLuíDO NA LISTA DE PREÇOS</p> <p>Mediante comunicação prévia à Lorefar, apenas se aceitará a mercadoria devolvida por defeito, nunca por vidros partidos ou falta de algum componente. Nestes casos pedimos que entrem em contacto conosco para lhes enviarmos urgentemente as peças requeridas.</p> <p>Não serão admitidas alterações nem devoluções de mercadoria em bom estado. Em caso de aceitação explícita por parte da Lorefar, na sua recepção e comprovação emitir-se-á um débito de 20% a título de depreciação e classificação da mercadoria.</p>	<p>Die Information über unsere Produkte kann im Zusammenhang mit den Verbesserungen ihrer technischen Eigenschaften und ihres Designs jederzeit geändert werden.</p> <p>Faro Barcelona behält sich das Recht vor, seine Modelle jederzeit und ohne vorherige Ankündigung vom Markt zu nehmen, ohne dass sich daraus ein Anrecht auf Beschwerden ableiten könnte.</p> <p>Die Bedingungen, Eigenschaften und Preise der Produkte in diesem Katalog gelten zum Datum der Drucklegung des Katalogs vorbehaltlich Druckfehler und können jederzeit geändert werden. Diese Preise gelten für den Direktverkauf an den Kunden.</p> <p>DIE MEHRWERTSTEUER IST NICHT IN DEN PREISEN EINGESCHLOSSEN</p> <p>Nach vorheriger Kommunikation kann Lorefar die Rücklieferung von schadhafter Ware akzeptieren, jedoch niemals wegen beschädigten Glasteilen oder fehlenden Komponenten. In letzteren Fällen setzen Sie sich bitte zwecks schneller Zusage der notwendigen Teile in Verbindung.</p> <p>Wir tauschen keine Waren in gutem Zustand um oder nehmen sie zurück. Bei ausdrücklicher Annahme durch Lorefar nach Erhalt und Überprüfung stellen wir Ihnen 20% des Preises für Wertverminderung und Handhabung der Ware in Rechnung.</p>	<p>De informatie over onze producten kan gewijzigd worden met als doel de technische eigenschappen of het design te verbeteren.</p> <p>Faro Barcelona behoudt zich het recht voor om aangekondigd modellen te schrappen of te wijzigen en zonder dat dit aanleiding tot een klacht wordt.</p> <p>De voorwaarden, eigenschappen en prijzen van de producten in deze catalogus zijn geldig op het moment van druk van de catalogus tenzij sprake is van een drukfout. Zij zijn onderhevig aan mogelijke wijzigingen. De getoonde prijzen betreffen verkoopprijzen.</p> <p>Btw NIET BIJ DE PRIJS INBEGREPEN</p> <p>Lorefar aanvaardt uitsluitend defecte teruggezonden goederen nadat zij hierover van tevoren op de hoogte is gesteld. Dit geldt niet voor gebroken glas of het ontbreken van onderdelen. In deze gevallen wordt u verzocht met ons contact op te nemen zodat wij u zo snel mogelijk de gewenste onderdelen kunnen toezenden.</p> <p>Ruilen of terugsturen van goederen in correcte staat is niet toegestaan. In geval van uitdrukkelijke aanvaarding door Lorefar wordt bij ontvangst en controle een heffing van 20% voor waardevermindering en classificatie van de goederen toegepast.</p>	<p>Οι πληροφορίες σχετικά με τα προϊόντα μας ενδέχεται να τροποποιηθούν με στόχο τη βελτίωση των τεχνικών χαρακτηριστικών ή του σχεδίου.</p> <p>Η Faro Barcelona διατηρεί το δικαίωμα ακύρωσης ή τροποποίησης οποιουδήποτε μοντέλου χωρίς προηγούμενη προειδοποίηση και χωρίς αυτό να αποτελεί αιτία απαίτησης επιστροφής χρημάτων. Οι όροι, τα χαρακτηριστικά και οι τιμές των προϊόντων που παρουσιάζονται σε αυτόν τον κατάλογο είναι αυτά που ισχύουν κατά την ημερομηνία της εκτύπωσης του καταλόγου, εκτός τυπογραφικών λαθών, και υπόκεινται σε αλλαγές. Ο ΦΠΑ ΔΕΝ ΣΥΜΠΕΡΙΛΑΜΒΑΝΕΤΑΙ ΣΤΗΝ ΤΙΜΗ</p> <p>Μετά από συνεννόηση με τη Lorefar, γίνονται αποδεκτές επιστροφές μόνο αν πρόκειται για ελαττωματικά εμπορεύματα και όχι για θραύση κρυστάλλων ή απουσία κάποιου στοιχείου. Στις περιπτώσεις αυτές, παρακαλούμε να έρθετε σε επαφή μαζί μας για να σας στείλουμε επείγοντως τα απαιτούμενα μέρη.</p>
RUS	CZ	BL	PL
<p>Информация относящаяся к нашей продукции может быть модифицирована с целью улучшить технические или внешние характеристики.</p> <p>Faro Barcelona сохраняет за собой право аннулировать или модифицировать любую модель без предупреждения и без того что это послужит причиной для жалоб.</p> <p>Условия, характеристики и цены на изделия, указанные в данном каталоге, действительны на дату его выпуска, за исключением опечаток в каталоге, и могут быть изменены. В каталоге указаны розничные цены.</p> <p>БЕЗ УЧЕТА НДС</p> <p>В соответствии с правилами, компания Lorefar принимает возврат изделий только при наличии дефектов, но ни в коем случае не при разбитии стекла или отсутствии какой-либо детали. В таком случае, пожалуйста, свяжитесь с нами, чтобы мы отправили вам необходимые детали.</p> <p>Товар в рабочем состоянии не подлежит обмену или возврату. В случае подтверждения компанией Lorefar наличия дефектов, после возврата и проверки, начисляется 20% стоимости с учетом амортизации и классификации товаров.</p>	<p>Technické informace uvedené v katalogu mohou být modifikovány za účelem zdokonalování vlastností svítidel nebo jejich designu.</p> <p>Producent Faro Barcelona si vyhrazuje právo konstrukčních změn nabízených modelů bez předchozího oznámení a tato skutečnost nemůže být předmětem jakékoliv stížnosti či reklamace.</p> <p>Podmínky, technické specifikace a ceny produktů uvedených v katalogu jsou platné ke dni vydání katalogu nového.</p> <p>VŠECHNY CENY JSOU UVEDENY BEZ DPH., Zboží může být vráceno pouze po předchozím souhlasu od společnosti PAXI, na základě poruchy nebo vady ovšem nikdy na základě poškozeného skla nebo chybějícího dílu. V takových případech nás, prosím, kontaktujte, abychom Vám mohli požadované části svítidel urgentně zaslat. Výměny nebo vrácení zboží v dobrém technickém stavu je nepřijatelné.</p>	<p>Техническата информация, представена в нашият каталог, може да бъде променена с цел да подобри представянето или дизайна на продуктите.</p> <p>Фаро Барселона си запазва правото да отменя или променя всеки модел без предварително осведомяване и без това да се счита причина за оплаквания.</p> <p>Условията, техническите характеристики и цените на продуктите показани в този каталог са ефективни към датата на отпечатването на каталога, с изключение на грешки при отпечатване и са обект на възможни промени.</p> <p>Цените в каталога са публичните цени.</p> <p>ЦЕНИТЕ НЕ ВКЛЮЧВАТ ДДС.</p> <p>Връщане на закупена стока ще да бъдат приета единствено след писмено осведомяване на ЛОРЕФАР на основание дефекти и в никакъв случай на основание чулено стъкло или липсващи части. В такива случаи моля свържете се с нас, за да ви изпратим липсващите части по спешност.</p> <p>Размяна или връщане на стока в добро състояние няма да бъде извършвана. В случай на спешно приемане от ЛОРЕФАР 20 % такса ще бъде наложена за приемане и проверка, за обезценяване и класификация на продуктите.</p>	<p>Informacje techniczne wyszczególnione w naszym katalogu mogą być modyfikowane w celu poprawienia właściwości lub wzornictwa produktów.</p> <p>Faro Barcelona ma prawo do anulowania i modyfikowania każdego z modeli bez uprzedniego informowania i nie przyjmuje skarg z tego tytułu.</p> <p>Warunki, opis techniczny oraz ceny artykułów, które pojawiają się w katalogu są aktualne do czasu przedruku katalogu za wyjątkiem pomyłek w druku, które podlegają ewentualnej zmianie. Ceny w katalogu są cenami publicznymi.</p> <p>CENY NIE ZAWIERAJĄ STAWKI VAT.</p> <p>Ewentualne zwroty mogą być zaakceptowane po uprzedniej zgodzie przez Lorefar na podstawie stwierdzenia, że są wadliwe, nigdy nie przyjmowane są zwroty artykułów, z powodu stłuczenia szkła czy brakujących części, w tym przypadku prosimy o kontakt w celu wysłania potrzebnych części w trybie natychmiastowym.</p> <p>Wymiany lub zwroty artykułów w dobrym stanie nie będą zaakceptowane. W przypadku wyraźnej akceptacji przez Lorefar, 20% opłaty może być poniesione na otrzymanie i sprawdzenie, w celu sklasyfikowania uszkodzenia artykułu.</p>

Ref.	Pag.	Ref.	Pag.	Ref.	Pag.	Ref.	Pag.
01001	524	20033-134	90	20123	264	20304-82	130
01004	366	20033-135	90	20124	264	20305-83	130
01006	366	20033-80	98	20125	264	20305-84	130
01007A	50	20033-81	98	20126	264	20306-85	130
01009A	364	20034-122	88	20127	264	20307-86	130
01014A	364	20034-123	88	20128	264	20307-87	130
01016	38	20034-133	90	20129	264	20308-89	254
01017	38	20034-134	90	20130	264	20309-90	254
01025A	50	20034-135	90	20131	264	20309-91	254
01026A	364	20034-80	98	20160	214	20325	42
01027A	364	20034-81	98	20160-3L	284	20326	42
01040	522	20034-88	142	20160-5L	284	20327	408
01041	522	20040-122	372	20160-7L	284	20328	409
01046	64	20040-123	372	20161	214	20329	188
02100501	566	20040-133	370	20161-3L	284	20335-116	334
02100502	566	20040-134	370	20161-5L	284	20335-117	334
02100503	566	20040-135	370	20161-7L	284	20335-140	334
02100601	570	20042-122	372	20164-95	62	20335-141	334
02100602	570	20042-123	372	20164-96	62	20335-142	334
02100603	570	20042-133	370	20165-95	378	20335-143	334
02100701	568	20042-134	370	20165-96	378	20335-144	334
02100702	568	20042-135	370	20166-95	214	20336-119	82
02100801	582	20047	272	20166-96	214	20336-120	79
02100901	582	20048	272	20167	378	20336-145	82
02101001	552	20049	360	20168	378	20336-146	82
02101002	552	20050	226	20169	214	20336-147	82
02101101	552	20050-3L	282	20170-01	436	20336-148	82
02101102	552	20050-5L	282	20170-02	436	20336-149	82
02101301	554	20050-7L	282	20170-03	436	20337-116	78
02101302	554	20051	272	20171-01	436	20337-117	80
02101401	570	20052	446	20171-02	436	20337-140	80
02101402	570	20053	446	20171-03	436	20337-141	80
02101501	554	20054	136	20173-01	436	20337-142	80
02101601	554	20055	136	20173-02	436	20337-143	80
02111001	560	20056	60	20173-03	436	20337-144	80
02111002	560	20057	60	20208	34	20338-116	202
02121001	560	20058	396	20209	34	20338-117	202
02121002	560	20059	396	20210	34	20338-119	204
02200501	566	20060	398	20221-129	416	20338-120	204
02200502	566	20062	398	20221-150	416	20338-140	202
02200503	566	20063	398	20222-150	416	20338-141	202
02300101	568	20064	398	20223-129	416	20338-142	202
02400101N	570	20065	396	20223-150	416	20338-143	202
02400102	570	20066	396	20224-150	416	20338-144	202
20026	148	20069	44	20225-130	120	20338-145	204
20029	148	20075	100	20225-151	120	20338-146	204
20030	148	20076	100	20226-151	120	20338-147	204
20031-122	340	20077	348	20227-131	120	20338-148	204
20031-123	340	20079	272	20227-152	120	20338-149	204
20031-80	342	20092	312	20228-152	120	20339-116	198
20031-81	342	20093	312	20229-132	262	20339-117	198
20031-88	430	20094	312	20229-153	262	20339-119	200
20032-122	340	20095	312	20231-132	262	20339-120	200
20032-123	340	20116	264	20231-153	262	20339-140	198
20032-80	342	20117	264	20300-92	420	20339-141	198
20032-81	342	20118	264	20301-93	420	20339-142	198
20032-88	430	20119	264	20301-94	420	20339-143	198
20033-122	88	20120	264	20302-92	420	20339-144	198
20033-123	88	20121	264	20303-93	420	20339-145	200
20033-133	90	20122	264	20303-94	420	20339-146	200

Ref.	Pag.	Ref.	Pag.	Ref.	Pag.	Ref.	Pag.
20339-147	200	20343-143-5L	268	24005-11	432	28268	208
20339-148	200	20343-144-5L	268	24005-12	432	28269	96
20339-149	200	20343-145-5L	270	24006-10	432	28270	96
20340-116-3L	284	20343-146-5L	270	24006-11	432	28271	96
20340-116-5L	284	20343-147-5L	270	24006-12	432	28272	94
20340-116-7L	284	20343-148-5L	270	24007-10	432	28274	338
20340-117-3L	284	20343-149-5L	270	24007-11	432	28275	338
20340-117-5L	284	20400	182	24007-12	432	28277	206
20340-117-7L	284	20401	182	24015	400	28278	206
20340-119-3L	284	20402	182	24016	400	28279	206
20340-119-5L	284	20403	184	24020-31	122	28280	206
20340-119-7L	284	20404	184	24020-32	122	28281	208
20340-120-3L	284	20405	184	24023-33	122	28282	208
20340-120-5L	284	20406	186	24023-34	122	28283	206
20340-120-7L	284	20407	186	24033-01	448	28284	206
20340-140-3L	284	20408	186	24033-02	448	28285	206
20340-140-5L	284	20500	332	24033-03	448	28286	206
20340-140-7L	284	20501	332	24034-04	128	28287	206
20340-141-3L	284	20502	332	24034-05	128	28299	512
20340-141-5L	284	20508-136	332	24037-07	128	28300	196
20340-141-7L	284	20509-137	332	24037-08	128	28301	196
20340-142-3L	284	20510-138	332	24037-09	128	28302	196
20340-142-5L	284	20512-136	75	24521	64	28350	46
20340-142-7L	284	20513-137	76	24528	376	28351	46
20340-143-3L	284	20514-138	76	24531	58	28352	46
20340-143-5L	284	20516-136	76	24536	58	28370	118
20340-143-7L	284	20517-137	74	28200	346	28371	118
20340-144-3L	284	20518-138	76	28202	150	28373	278
20340-144-5L	284	20546	158	28209	222	28374	278
20340-144-7L	284	22005	230	28209-1L	274	28375	222
20340-145-3L	285	22006	230	28209-2L	274	28375-1L	274
20340-145-5L	285	22007	230	28209-3L	276	28375-2L	274
20340-145-7L	285	22008	230	28209-4L	276	28375-3L	276
20340-146-3L	285	22011	230	28209-5L	278	28375-4L	276
20340-146-5L	285	22012	230	28210	222	28375-5L	278
20340-146-7L	285	22013	230	28210-1L	274	28376	222
20340-147-3L	285	22014	230	28210-2L	274	28376-1L	274
20340-147-5L	285	22017	230	28210-3L	276	28376-2L	274
20340-147-7L	285	22018	230	28210-4L	276	28376-3L	276
20340-148-3L	285	22019	230	28210-5L	278	28376-4L	276
20340-148-5L	285	22020	230	28211	52	28376-5L	278
20340-148-7L	285	22023	218	28212	52	28378	52
20340-149-3L	285	22024	218	28251	96	28379	52
20340-149-5L	285	22025	218	28252	95	28380	56
20340-149-7L	285	22028	232	28253	96	28382	56
20342-116	368	22029	232	28254	96	28383	56
20342-117	368	22032	232	28255	96	28385	56
20342-140	368	22033	232	28256	96	28387	46
20342-141	368	23001-57	108	28257	338	28388	46
20342-142	368	23001-58	108	28258	338	28398	240
20342-143	368	23002-57	108	28259	338	28399	240
20342-144	368	23002-58	108	28260	206	28413	444
20343-116-5L	268	23003-59	110	28261	206	28430	48
20343-117-5L	268	23003-60	110	28262	206	28431	48
20343-119-5L	270	23004-57	428	28263	206	29039	361
20343-120-5L	270	23004-58	428	28264	206	29040	361
20343-140-5L	268	23065	108	28265	206	29043	457
20343-141-5L	268	23066	108	28266	208	29047	104
20343-142-5L	268	24005-10	432	28267	208	29049	104

Ref.	Pag.	Ref.	Pag.	Ref.	Pag.	Ref.	Pag.
29306	504	29867	144	40112	574	41026	406
29309	254	29868	144	40113	574	41029	404
29310	504	29869	144	40114	572	41030	404
29311	140	29873	454	40115	572	41031	404
29312	140	29874	454	40116	574	41032	404
29313	254	29875	454	40117	574	42919	592
29326	444	29876	454	40118	572	42931	592
29328	444	29877	298	40119	572	43396	576
29329	444	29878	298	40120	574	43397	576
29330	444	29881	102	40121	574	43398	576
29331	444	29882	102	40122	575	43399	580
29332	146	29883	102	40123	575	43400	580
29333	146	29884	102	40124	575	43401	578
29335	146	29897	454	40125	575	43402	578
29336	146	29898	102	40126	575	43403	578
29395	428	29899	102	40127	575	43404	588
29396	376	29910	412	40135	352	43405	588
29397	242	29911	412	40136N	352	43406	576
29398	112	29912	414	40522	468	43407	576
29399	112	29913	70	40523	468	43408	576
29468	240	29914	70	40524	468	43409	580
29565	428	29915	72	40525	468	43410	580
29566	376	29916	192	40526	469	43411	578
29567	242	29917	192	40527	469	43412	578
29568	112	29918	194	40528	469	43413	578
29569	112	29974	440	40529	469	43420	588
29680-19	434	29975	440	40530	470	43421	588
29680-20	434	29976	440	40531	470	43425	584
29680-21	434	29979	138	40532	466	43426	584
29681-19	434	29980	442	40533	470	43427	584
29681-20	434	29981	442	40534	471	43428	584
29681-21	434	29982	442	40535	471	43429	586
29683-19	434	29983	442	40536	471	43430	586
29683-20	434	29984	138	40537	471	43431	586
29683-21	434	29985	138	40538	468	43432	586
29685-04	132	29986	258	40539	468	43500	457
29685-05	132	29997	142	40540	468	43502	457
29685-06	132	40065	48	40541	468	43521	361
29687-07	132	40070	374	40542	469	43522	361
29687-08	132	40076	534	40543	469	43525	458
29687-09	132	40077	310	40544	469	43527	458
29690	516	40078	228	40545	469	43528	458
29691	224	40085	530	40546	470	43531	298
29692D	106	40086	530	40547	470	43534	298
29693D	106	40087	530	40548	470	43600	388
29694	224	40088	530	40549	470	43601	388
29695	516	40090	516	40565	471	43720	602
29696	224	40091	516	40566	471	43721	602
29697	106	40092	516	40567	471	43722	292
29698	106	40093	516	40568	467	43723	292
29699	224	40095	514	40660	456	43724	602
29764	66	40096	514	40661	456	43725	602
29844	504	40097	514	40663	456	43726	292
29846	114	40098	514	40664	456	43727	292
29847	114	40099	514	40667	456	43728	294
29848	266	40102	362	40994	400	43729	294
29849	266	40103	362	40996	400	43730	294
29864	254	40104	362	41019	400	43731	294
29865	254	40110	572	41020	400	43732	294
29866	144	40111	572	41025NA	402	43740	452

Ref.	Pag.	Ref.	Pag.	Ref.	Pag.	Ref.	Pag.
43741	452	43880	550	57211-03	62	62135	316
43742	452	43881	550	57211-04	62	62139	220
43743	452	43882	550	57300	346	62140	316
43744	452	43883	550	57301	346	62142	316
43745	452	43884	550	57312	150	62143	316
43746	300	43885	550	57313	150	62144	316
43747	300	43886	550	57314	150	62145	316
43748	472	43887	550	57315	164	62146	316
43749	472	43901	558	57316	164	62150	518
43750	472	43902	558	57317	164	62151	518
43751	472	43903	558	57318	374	62152	518
43752	294	43904	558	57319	374	62153	518
43753	294	43905	558	57320	374	62154	518
43754	236	43906	558	57402	360	62155	518
43755	236	43907	558	57403	360	62156	52
43756	236	43908	558	60006	528	62157	52
43757	602	44001	556	60007	528	62161	350
43758	300	44002	556	60008	528	62162	350
43759	472	44003	590	60009	528	62163	350
43760	472	44004	590	60010	532	62164	350
43761	294	44005	590	60011	532	62168	52
43762	292	44006	590	60012	220	62169	52
43763	292	44007	590	60013	220	62170	518
43764	300	44008	590	61080	526	62171	518
43765	472	44100	564	61081	526	62172	518
43766	472	44101	564	61082	526	62173-50	508
43767	358	44102	564	61083	526	62173-51	508
43768	358	44103	564	61084	526	62173-69	510
43770	602	44104	565	61085	526	62173-78	510
43771	602	44105	565	61086	526	62174-50	508
43772	292	44106	565	61087	526	62174-51	508
43773	292	44107	565	61088	526	62174-69	510
43776	300	44108	562	61101	210	62174-78	510
43777	292	44109	562	61103	210	62300	520
43778	472	44110	562	61104	210	62301	520
43779	472	44111	562	61105	210	62302	520
43790	296	44112	563	61117	210	62303	520
43791	296	44113	563	62104	390	62350	394
43792	356	44114	563	62105	464	62351	394
43793	356	44115	563	62108	464	62353	394
43794	604	51129	166	62111	392	62355	354
43795	604	51133	166	62114	392	62356	354
43796	92	51135	166	62115	350	62360	344
43797	92	51908	156	62116	390	62361	344
43798	92	51909	156	62116N	390	62703	406
43799	92	51910	156	62117	390	62704	406
43800	296	52057	154	62117N	390	62706	450
43806	600	52058	154	62118	390	62707	394
43807	600	52059	166	62120	390	62708	394
43810	294	52061	166	62121	390	62710	394
43811	294	52064	154	62122	392	62711	394
43814	290	52065	154	62123	392	62716	460
43815	290	52071	156	62126	392	62717	460
43816	290	53415	152	62128	392	62718	460
43817	290	53416	152	62129	392	62724	460
43822	358	56100	162	62130	354	62725	460
43823	358	56101	162	62131	354	62726	460
43824	290	56102	162	62132	316	62730	380
43825	290	56103	162	62133	316	62731	380
43826	290	57211-01	62	62134	316	62732	380

Ref.	Pag.	Ref.	Pag.	Ref.	Pag.	Ref.	Pag.
62734	380	63282	596	63604	544	64255-126	212
62735	380	63283	596	63605	544	64255-126-3L	285
62736	380	63284	486	64026	462	64255-126-5L	285
62750	382	63285	492	64027	520	64255-126-7L	285
62751	382	63286	588	64030	352	64255-127	212
62752	382	63291	326	64096	318	64255-127-3L	285
62753	386	63311	494	64097	318	64255-127-5L	285
62754	386	63312	494	64099	238	64255-127-7L	285
62755	386	63316	546	64133	226	64255-128	212
62756	386	63317	546	64133-3L	283	64255-128-3L	285
62757	386	63318	546	64133-5L	283	64255-128-5L	285
62758	386	63319	546	64133-7L	283	64255-128-7L	285
62760	384	63404	326	64135-3L	283	64256	212
62761	384	63408	320	64135-5L	283	64257	212
62762	384	63410	320	64135-7L	283	64258	212
62763	384	63420	484	64137	228	64259	212
62765	382	63421	484	64137-3L	283	64262	238
62802	226	63422	484	64137-5L	283	64263	238
62802-3L	283	63425	594	64137-7L	283	64270	336
62802-5L	283	63428	476	64160	234	64271	336
62802-7L	283	63429	478	64162	234	64272	336
62803	226	63430	478	64169	166	64273	336
62803-3L	283	63435	480	64172	220	64274	336
62803-5L	283	63436	482	64174	256	64275-111	84
62803-7L	283	63480	492	64188	326	64275-112	86
62819	474	63481	594	64188N	326	64275-113	86
62820	474	63490	594	64210A	602	64275-114	86
62821	474	63491	594	64211A	602	64275-115	86
62822	474	63503	532	64212A	602	64276-111	86
62830	530	63504	534	64213A	602	64276-112	86
62831	530	63505	534	64214A	602	64276-113	85
62832	542	63506	534	64215A	602	64276-114	86
62833	542	63507	540	64223	236	64276-115	86
62834	542	63508	540	64231	287	64277	314
62835	542	63509	540	64232	287	64278	314
62836	542	63510	534	64250	318	64279	314
62837	542	63512	540	64251	318	64280	314
62966	328	63513	540	64255	212	64281	314
62969	329	63514	540	64255-111-3L	285	64282	314
62980	328	63520	538	64255-111-5L	285	64303	438
62981	328	63521	538	64255-111-7L	285	64304	438
62983	329	63522	538	64255-112-3L	285	64305	438
62986	506	63523	538	64255-112-5L	285	64306-01	422
62987	506	63546	536	64255-112-7L	285	64306-02	422
62988	450	63547	536	64255-113-3L	285	64306-35	418
63167	462	63548	536	64255-113-5L	285	64306-36	418
63173	488	63549	536	64255-113-7L	285	64306-37	418
63174	488	63550	536	64255-114-3L	285	64307-03	422
63175	488	63551	536	64255-114-5L	285	64307-35	418
63176	490	63552	536	64255-114-7L	285	64307-36	418
63177	490	63553	536	64255-115-3L	285	64307-37	418
63184	494	63554	536	64255-115-5L	285	64307-47	426
63225	494	63555	536	64255-115-7L	285	64307-71	424
63268	304	63556	536	64255-124	212	64308-01	422
63269	304	63557	536	64255-124-3L	285	64308-02	422
63270	308	63558	536	64255-124-5L	285	64308-35	418
63271	308	63559	536	64255-124-7L	285	64308-36	418
63275	308	63600	544	64255-125	212	64308-37	418
63278	486	63601	544	64255-125-3L	285	64309-03	422
63279	492	63602	544	64255-125-5L	285	64309-35	418
63281	596	63603	544	64255-125-7L	285	64309-36	418

Ref.	Pag.	Ref.	Pag.	Ref.	Pag.	Ref.	Pag.
64309-37	418	64315-46	260	66409	500	68596-1L	216
64309-47	426	64315-47	252	66410	500	68596-3L	281
64309-71	424	64315-48	252	66411	502	68596-5L	281
64310-04	126	64315-49	252	66412	502	68596-7L	281
64310-05	126	64315-54	258	66413	503	68597-1L	216
64310-38	124	64315-55	258	66414	503	68597-3L	281
64310-39	124	64315-56	258	66415	503	68597-5L	281
64310-40	124	64316-01	126	66416	503	68597-7L	281
64311-06	126	64316-02	126	68145	218	68600-50	244
64311-38	124	64316-35	124	68145-3L	283	68600-51	244
64311-39	124	64316-36	124	68145-5L	283	68602	287
64311-40	124	64316-37	124	68145-7L	283	68604-44	286
64311-48	116	64317-03	126	68146	218	68604-45	286
64312-07	126	64317-35	124	68146-3L	283	68604-46	286
64312-08	126	64317-36	124	68146-5L	283	68604-47	286
64312-41	124	64317-37	124	68146-7L	283	68604-48	286
64312-42	124	64317-47	116	68283	256	68604-49	286
64312-43	124	64317-71	54	68284	256	68604-54	286
64313-09	126	64318	402	68298	322	68604-55	286
64313-41	124	64319	402	68317	322	68604-56	286
64313-42	124	64329-154	260	68461	240	68604-62	286
64313-43	124	64330-154	260	68462	66	68604-63	286
64313-49	116	64331-132	286	68463	66	68604-64	286
64314-44	260	64331-153	286	68467N	388	68604-65	286
64314-44-3L	282	64331-154	286	68468N	388	68604-66	286
64314-44-5L	282	64332-132	282	68488	134	68604-67	286
64314-44-7L	282	64332-153	282	68489	134	68604-68	286
64314-45	260	64332-154	282	68493-01	448	68610	310
64314-45-3L	282	64400-10	430	68493-02	448	68611	310
64314-45-5L	282	64400-11	430	68493-03	448	68615	306
64314-45-7L	282	64400-12	430	68496	448	68616	306
64314-46	260	64602-111	178	68497	394	68617	306
64314-46-3L	282	64701	170	68498	448	68618	306
64314-46-5L	282	65134	228	68499	394	68619	302
64314-46-7L	282	65134-72	248	68500	54	68620	302
64314-47	252	65134-73	250	68501	54	68621	302
64314-47-3L	281	65134-74	250	68508	394	68622	302
64314-47-5L	281	65134-75	250	68509	394	68623	302
64314-47-7L	281	65134-76	248	68563	240	68624	302
64314-48	252	65134-77	248	68590-69	246	68625	324
64314-48-3L	281	65137	308	68590-70	246	68626	324
64314-48-5L	281	66400-101	496	68591-1L	216	68627	324
64314-48-7L	281	66400-102	496	68591-3L	281	68628	324
64314-49	252	66400-105	496	68591-5L	281	74465	36
64314-49-3L	281	66400-106	496	68591-7L	281		
64314-49-5L	281	66400-97	496	68592-1L	216		
64314-49-7L	281	66400-98	496	68592-3L	281		
64314-54	258	66401-100	498	68592-5L	281		
64314-54-3L	282	66401-103	498	68592-7L	281		
64314-54-5L	282	66401-104	498	68593-1L	216		
64314-54-7L	282	66401-107	499	68593-3L	281		
64314-55	258	66401-108	499	68593-5L	281		
64314-55-3L	282	66401-109	499	68593-7L	281		
64314-55-5L	282	66401-110	499	68594-1L	216		
64314-55-7L	282	66401-99	498	68594-3L	281		
64314-56	258	66403	502	68594-5L	281		
64314-56-3L	282	66404	502	68594-7L	281		
64314-56-5L	282	66405	500	68595-1L	216		
64314-56-7L	282	66406	500	68595-3L	281		
64315-44	260	66407	500	68595-5L	281		
64315-45	260	66408	500	68595-7L	281		

Alphabetical index

Academy	Table	150	Confetti	Ceiling	244	Fresh	Ceiling	570	Lead	Wall	406
Academy	Wall	346	Confetti	Wall	508	Gabo	Wall	386	Lena	Clip-on	166
Aina	Ceiling	256	Conga	Ceiling	258	Gala	Wall	534	Lena	Table	154
Aire	Ceiling	186	Conga	Floor	126	Gas	Ceiling	588	Leo	Ceiling	296
Akane	Table	118	Conga	Table	126	Guadalupe	Floor	98	Leo	Floor	92
Amelia	Ceiling	310	Conga	Wall	422	Guadalupe	Table	98	Leo	Table	92
Amelia	Table	48	Corb	Wall	352	Guadalupe	Wall	342	Leo	Track	604
Anna	Ceiling	232	Costas	Ceiling	246	Guest	Floor	64	Leo	Wall	356
Anouk	Table	152	Costas	Wall	510	Haka	Ceiling	250	Leser	Wall	406
Argón	Ceiling	578	Cotton	Wall	502	Han	Wall	524	Liggera	Ceiling	272
Aris	Ceiling	324	Cove	Wall	492	Handy	Wall	444	Liggera	Floor	100
Art	Ceiling	283	Crater	Ceiling	240	Homs	Wall	462	Liggera	Table	100
Artis	Floor	134	Cronos	Wall	382	Hoshi	Table	46	Liggera	Wall	348
Artis	Table	134	Danka	Ceiling	236	Hyde	Ceiling	572	Lina	Ceiling	232
Artis	Wall	448	Dante	Wall	380	Inviting	Clip-on	164	Linda	Ceiling	254
Aurea	Wall	350	Danubio	Wall	544	Inviting	Table	150	Linda	Floor	140
Baobab	Table	156	Diana	Ceiling	230	Inviting	Wall	346	Linda	Table	140
Bel	Wall	404	Diula	Wall	506	Isabelle	Ceiling	196	Linda	Wall	504
Bela	Clip-on	162	Dolme	Ceiling	318	Isabelle	Wall	512	Link	Ceiling	298
Berni	Floor	146	Dome	Ceiling	192	Ito	Table	156	Link	Floor	102
Berni	Table	146	Dome	Floor	72	Janet	Ceiling	308	Link	Table	102
Berni	Wall	444	Dome	Table	70	Jellyfish	Floor	64	Link	Wall	454
Bianca	Wall	534	Dome	Wall	414	Joy	Wall	520	Logos	Ceiling	328
Bic	Ceiling	320	Dominica	Floor	88	Juliet	Wall	402	Loke	Wall	400
Black	Floor	66	Dominica	Table	88	Kale	Wall	406	Loop	Ceiling	242
Board	Wall	522	Dominica	Wall	340	Kamen	Wall	494	Loop	Floor	112
Boc	Wall	394	Dop	Ceiling	590	Kappu	Wall	476	Loop	Table	112
Boken	Wall	404	Drum	Floor	122	Kera	Wall	520	Loop	Wall	428
Brume	Ceiling	310	Drum	Table	122	Kiva	Wall	542	Lox	Ceiling	550
Brume	Wall	534	Duas	Wall	388	Kivi	Ceiling	558	Luan	Ceiling	592
Buddy	Table	34	Eaco	Wall	490	Klee	Wall	396	Luang	Floor	110
Calma	Wall	536	Ebba	Ceiling	592	Kombo	Ceiling	216	Luang	Table	108
Cata	Ceiling	188	Elsa	Wall	492	Lago	Wall	532	Luang	Wall	428
Cata	Table	42	Eres	Wall	462	Lao	Ceiling	457	Lula	Table	56
Cata	Wall	408	Eterna	Wall	432	Lao	Floor	104	Lumina	Ceiling	177
Celia	Wall	374	Flac	Ceiling	564	Lao	Table	104	Lumina		170
Charlotte	Ceiling	240	Flic	Ceiling	562	Lao	Wall	361	Luna	Wall	494
Chera	Wall	488	Flin	Wall	402	Le Petit	Wall	350	Lune	Wall	470
Claire	Ceiling	226	Fold	Wall	438	Le Vita	Ceiling	224	Lupe	Floor	142
Click	Wall	388	Foro	Ceiling	326	Le Vita	Floor	106	Lupe	Table	142
Coco	Wall	456	Fox	Ceiling	552	Le Vita	Table	106	Lupe	Wall	430
Cocotte	Ceiling	318	Frame	Wall	436	Le Vita	Wall	516	Mabe	Wall	530

Magma	Ceiling	240	Nit	Wall	366	Savoy	Floor	130	Ten	Table	52
Magritte	Wall	526	Niva	Ceiling	584	Savoy	Table	130	Ten	Wall	518
Mambo	Ceiling	252	Noon	Wall	354	Savoy	Wall	420	Tender	Ceiling	312
Mambo	Floor	116	Novo	Wall	460	Sera	Wall	520	Tera	Wall	494
Mambo	Table	116	Nubo	Wall	528	Seven	Ceiling	322	Tide	Wall	538
Mambo	Wall	426	Olaf	Wall	486	Shan	Table	44	Tierra	Ceiling	182
Mar	Ceiling	184	Orleans	Ceiling	298	Shoku	Ceiling	314	Tila	Wall	344
Marisol	Ceiling	220	Orleans	Wall	361	Side	Ceiling	316	Timit	Wall	384
Marlin	Ceiling	226	Oslo	Wall	486	Smile	Wall	354	Tola	Ceiling	329
Martinica	Floor	90	Otto	Table	154	Snap	Wall	360	Trama	Wall	480
Martinica	Table	90	Otton	Wall	496	Snow	Wall	492	Tree	Ceiling	254
Martinica	Wall	370	Ovo	Wall	464	Sole	Wall	468	Tree	Floor	144
Matilda	Floor	76	Pam	Ceiling	234	Staff	Floor	58	Tree	Table	144
Matilda	Table	75	Papua	Floor	66	Stan	Ceiling	294	Treewood	Floor	60
Matilda	Wall	332	Pepper	Clip-on	166	Stan	Track	602	Tuk	Wall	594
May	Wall	514	Perla	Wall	530	Stan	Wall	292	Tupai	Ceiling	248
Maya	Wall	362	Ping	Wall	532	Stan Slim	Ceiling	294	Venice	Ceiling	212
Mega	Ceiling	320	Pixie	Wall	400	Stan Slim	Track	600	Venice	Floor	86
Milo	Wall	484	Plas	Wall	596	Stan Slim	Wall	358	Venice	Table	86
Mine	Ceiling	222	Plat	Ceiling	218	Stand Up	Floor	62	Venice	Wall	336
Mine	Table	52	Pluma	Ceiling	220	Stone	Wall	457	Vesper	Ceiling	258
Mizu	Ceiling	306	Press	Wall	394	Stood	Ceiling	266	Vesper	Floor	138
Moist	Ceiling	582	Pure	Wall	376	Stood	Floor	114	Vesper	Table	138
Moma	Table	54	Radón	Ceiling	576	Stood	Table	114	Vesper	Wall	442
Montreal	Floor	128	Rem	Floor	132	Stood	Wall	504	Vico	Ceiling	210
Montreal	Table	128	Rem	Table	132	Studio	Ceiling	206	Volga	Wall	540
Montreal	Wall	448	Rem	Wall	434	Studio	Clip-on	166	Volta	Floor	148
Mood	Wall	398	Retro	Ceiling	272	Studio	Floor	96	Volta	Table	148
Moy	Table	48	Retro	Wall	360	Studio	Table	96	Vuk	Ceiling	326
Moy	Wall	516	Rob	Wall	448	Studio	Wall	338	Well	Wall	352
Nais	Ceiling	560	Roda	Wall	450	Suau	Wall	392	Wet	Ceiling	582
Nash	Wall	474	Rol	Ceiling	302	Sumba	Ceiling	248	Whizz	Ceiling	214
Navi	Wall	594	Ron	Wall	430	Sumba	Table	54	Whizz	Floor	62
Neon	Ceiling	580	Room	Wall	440	Sumba	Wall	424	Whizz	Wall	378
Neu	Ceiling	588	Sahara	Wall	450	Sven	Ceiling	304	Windsor	Ceiling	262
Niko	Table	50	Saigon	Ceiling	264	Take Away	Table	38	Windsor	Floor	120
Niko	Wall	364	Saipan	Ceiling	248	Tast	Ceiling	556	Windsor	Table	120
Nila	Floor	136	Samba	Ceiling	260	Tatawin	Ceiling	202	Windsor	Wall	416
Nila	Table	136	Samba	Floor	124	Tatawin	Floor	82	Zon	Ceiling	326
Nila	Wall	446	Samba	Table	124	Tatawin	Table	78			
Nilo	Wall	546	Samba	Wall	418	Tatawin	Wall	334			
Nina	Ceiling	218	Savoy	Ceiling	254	Tecto	Ceiling	308			

**Showroom Barcelona**

Princesa 52
08003 Barcelona
Spain
Tel +34932387373
showroom.barcelona@faro.es

Showroom Madrid

Velázquez 35 4ºD
28001 Madrid
Spain
Tel +34689583571
showroom.madrid@faro.es

Showroom Paris

7 Rue d'Uzès
75002 Paris
France
Tel +33745061553
showroom.paris@faro.es

Showroom Buenos Aires

Ven Street Center Local 30
Av. Italia 4950
1622 Dique Luján
Buenos Aires Argentina
Tel +5491171390813
showroom.argentina@faro.es

Showroom Milano

Ecosistema showroom
Via Gaetano Giardino 5
20123 Milano

Showroom Manila

699 Malate
1004 Metro, Manila
Philippines

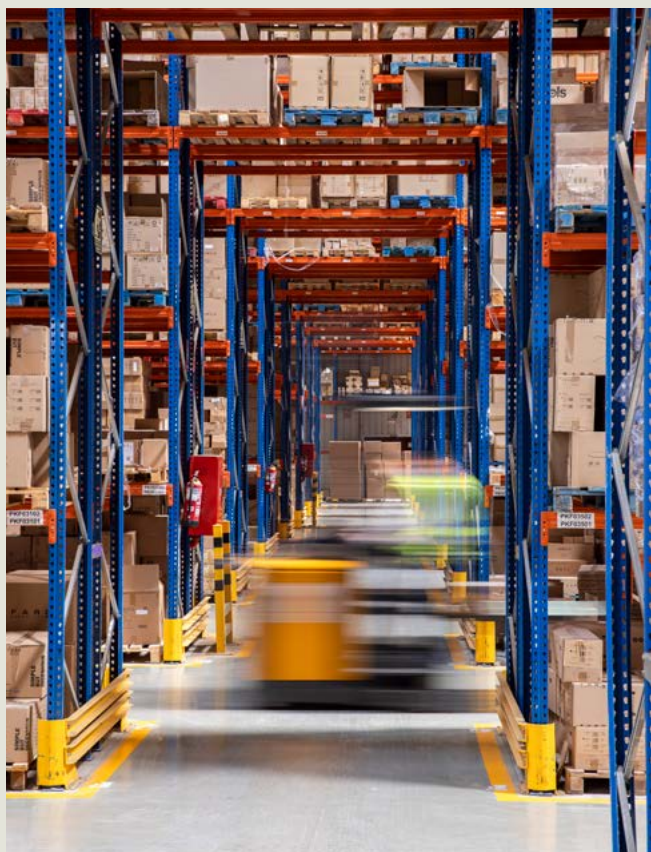
**Logistics Headquarters**

Dinámica 1 Pol. Ind. Santa Rita
08755 Castellbisbal
Spain
Tel +34937723949
info@faro.es

Logistics China

Room 1706-05, Glory International
Finance Center
25 Guicheng Road, Nanhai District
Foshan, Guangdong Province

Logistics USA

135 West 41nd Street Suite 1002
10036 New York
USA



Request visit

Be present.
Let light guide you
to a more conscious
way of living